

Hydraulic Chair Base Operating Instructions

Appearance and Names of Parts

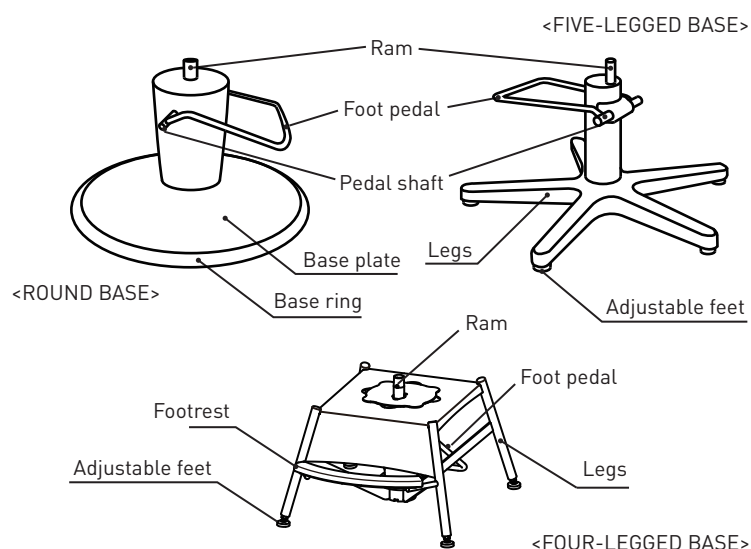

How to Use

(1) Raising the seat

Repeatedly step on the foot pedal lightly and release it, and the seat will rise gradually.

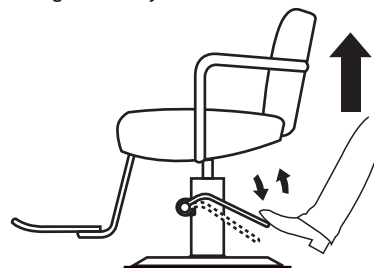

Note: Be careful not to press down the foot pedal too deeply. The seat will go up but also down, resulting in only a slight rise.

(2) Lowering the seat

Step on the foot pedal as deeply as it will go. The seat will keep going down while the foot pedal is depressed.

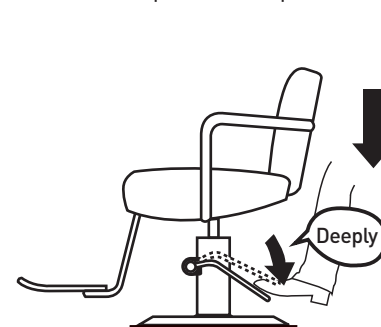

(3) Locking the seat

Raise the foot pedal up, and the seat will be locked.

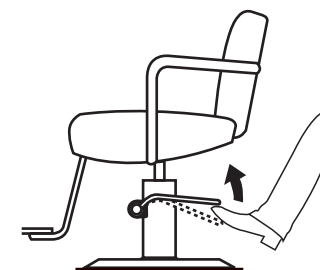

Maintenance Method

■ The following materials must not be used on the product:

Volatile chemicals, such as thinner, alcohol, gasoline, or kerosene; or abrasive waxes or sponges.

■ Do not use brushes or dish scrubbers on the product.

Do not use brushes or dish scrubbers on the metallic parts. They will leave scratches or unremovable stains on the parts.

■ Do not subject the product to chemicals or heat.

If chemicals get on the chair base covering, wipe them off immediately. Otherwise, the chair base covering may undergo changes in properties or discolor. Wipe with a cloth dampened with a solution of neutral detergent in water, and then with a dry, soft cloth.

Note: For maintenance of the chair top, please see the instructions supplied with the product.

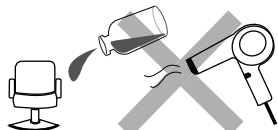

CAUTION

- Repeated raising and lowering of the seat may cause hydraulic oil to appear on the surface of the ram. This is for smooth sliding of the shaft and does not affect product quality.
- When the seat is unlocked, do not lift the chair top. The chair top may come off together with the ram. If the chair top has come off with the ram, put them back in place immediately, but this will allow air into the chair base and will not bring the product back to normal. Then, please contact your local authorised Takara Belmont dealer.

(3) Turning the seat

1 Lightly step on the foot pedal to unlock the seat.

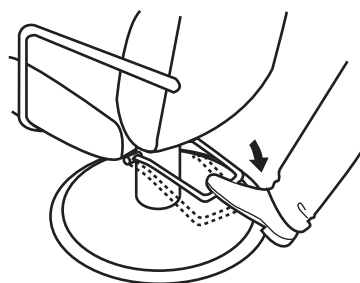

When the seat is locked, lightly step on the foot pedal to unlock the seat, allowing it to turn.

2 Turn the seat.

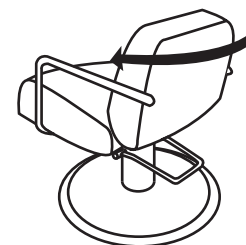

Hold the chair top by the backrest or armrests to turn the seat.



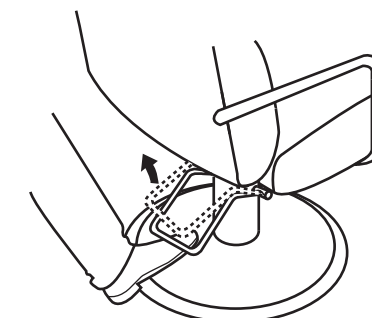



3 Lock the seat into the desired orientation.



With the seat in the desired orientation, hold the chair top and raise up the foot pedal to lock the seat so that the chair top will not turn.

Safety Warnings and Precautions (items that must be followed)

Please be sure to carefully read the safety warnings and precautions listed below and use the product correctly. They are intended for your safe use of the product and the prevention of harm to you or people around you, or property damage. These instructions are all important for safety and must be followed. Please familiarise yourself with the details of the safety symbols shown below before moving on to the main part of this document.

 WARNING This symbol indicates that failure to follow the instructions may result in death or serious injury.	 Display of precautions, warnings, and hazards in general	 Display of actions in general that the user must or should take
 CAUTION This symbol indicates that failure to follow the instructions may result in serious or moderate injury or property damage.	 Display of prohibited actions in general	 Display of the prohibition of disassembly, repairs, or modifications of the product

WARNING

Precautions to take when raising or lowering the seat.

When raising or lowering the seat, make sure that the chair top and the footrest are clear of any body parts. The chair top is heavy and can apply great force. If any body part becomes jammed in the product, serious injury may result.



Never attempt to disassemble, repair, or modify the product yourself.

Never allow anyone other than service technicians to disassemble, repair, or modify the product. Electric shock, fire, or abnormal operation of the product may result, causing serious injury.

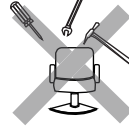

When moving the chair to another place, be careful where to hold it.

When moving the chair to another place, hold it by the base. Do not hold it by the chair top only. The chair base may come off, resulting in serious injury.



Do not stand up on the seat.

Do not stand up on the seat. The chair may fall.



CAUTION

When the chair top is raised, do not place your body weight on the footrest.

When the chair top is raised, do not place your body weight on the footrest. The chair may fall.



When turning the seat, pay attention to the surroundings of the chair top.

When turning the seat, be sure to check that no body parts are in the way of the chair top (or of the footrest, in particular). Otherwise, the chair top may hit the body part and cause injury.



The seat must always be in the lowest position when the customer sits in or gets out of the chair.

When having the customer sit in or get out of the chair, make sure that the seat is in the lowest position. Otherwise, the chair may fall, resulting in injury.
Four-legged base: When lowering the seat, pay extra attention to check that the heels of the customer's shoes, such as high heels, will not be caught by the footrest.



Do not drag the chair to move it to another place.

Do not drag the chair to move it to another place. The floor may become damaged. In the case of a round base, the base ring (the rubber rim of the base) will come off.



Do not place your feet on the base or apply an unbalanced load.

The chair may fall if you place your feet on the base or apply an unbalanced load. Make sure that the chair is on a solid, flat surface.



When the chair is not in use, lower the seat to the lowest position.

Lower the seat to the lowest position when the chair is not in use, for example, at the end of the day, as well as before long holidays. If the seat is left in a raised position, the ram may gather rust, rendering it unable to raise or lower the seat smoothly.



Precautions for Use

■ Compatibility with chair tops

Certain chair tops may not be combined with your chair base. For inquiries, please contact your local authorised Takara Belmont dealer.

■ Adjustable feet (on five- and four-legged bases)

If the installed chair is wobbly, be sure to correct the problem by turning the adjustable feet and then tighten the nuts (with a 13-mm wrench) to fix the length of the adjustable feet. Using the chair with loose nuts may damage the adjustable feet.

■ Disposal of the product

When disposing of the product or replaced parts, follow the laws and regulations applicable at the time and dispose of them appropriately.

TAKARA BELMONT
TAKARA BELMONT CORPORATION
1-1, 2-Chome, Higashi-shinsaibashi, Chuo-ku, Osaka, Japan
TEL: +81-6-6213-5945 FAX: +81-6-6212-3680