

YUME ESPOIR

Above floor plumbing Operating Instructions

○ Plumbing kits

- EA-ESPL [ESPOIR above floor plumbing kit - L]
- EA-ESPR [ESPOIR above floor plumbing kit - R]

○ Plumbing covers

- EA-ESPAL [ESPOIR above floor plumbing cover A-L]
- EA-ESPAR [ESPOIR above floor plumbing cover A-R]
- EA-ESPB [ESPOIR above floor plumbing cover B]
- EA-ESPC [ESPOIR above floor plumbing cover C]

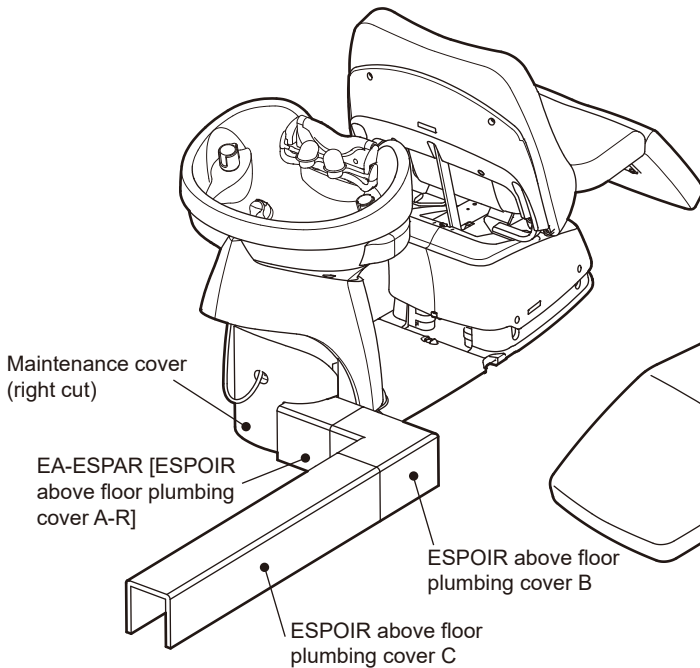

(The figure above shows EA-ESPR/EA-ESPAR/EA-ESPB/EA-ESPC.)

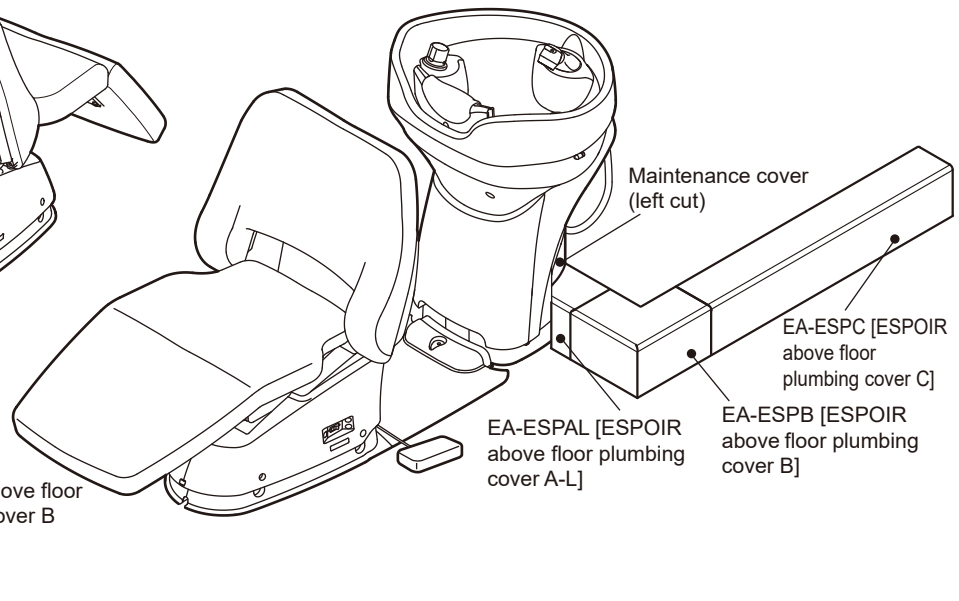

(The figure above shows EA-ESPL/EA-ESPAL/EA-ESPB/EA-ESPC.)

*This Operating Instructions is a supplementary Operating Instructions to be used only when above floor plumbing for the YUME ESPOIR is conducted.
For the operation of the main machine, follow *the YUME ESPOIR Operating Instructions*.

[Maintenance method]

■ Above floor plumbing cover

Wipe each cover with a dry soft cloth. If the cover is extremely dirty, wipe off the dirt with neutral detergent diluted with water and then wipe the cover with a dry cloth.



Never use volatile chemicals, such as a thinner, alcohol, nail varnish remover, gasoline, and kerosine; a wax containing an abrasive; a sponge containing an abrasive; a detergent containing an organic solvent, acid, alkali, and chlorine-based detergents; or a cleaning tool, such as brush. Failure to follow this instruction may cause the cover to become damaged or discolored.

○ Safety precautions (be sure to observe them)

■ Before use





Thoroughly read the safety precautions section and correctly use the product.





■ Notes on precautions







The safety precautions in this section are provided for the safe use of the product and the prevention of hazards and damage to the user and other people. All of these precautions include important information on safety. Be sure to observe them. If an accident occurs and the relevant safety precautions have not been observed, we shall bear no responsibility whatsoever for any injury or damage to the user or other people. In this case, the user of the product who has neglected to heed the safety precautions shall be responsible for the damage.

Pictograms are explained in detail as follows. Fully understand those pictograms and then read the body text.

■ Pictograms

 WARNING Indicates a hazardous situation which, if not avoided, could result in death or serious injury.	
 CAUTION Indicates a hazardous situation which, if not avoided, could result in minor or moderate injury and property damage.	
 Indication of notification of general danger, warning, or caution	 Indication of general obligation or instruction to the user
 Indication of general prohibited action	

 CAUTION	
 Do not step on the above floor plumbing cover. Failure to follow this instruction may cause the above floor plumbing cover to become damaged or result in injury.	 Do not splash water to the above floor plumbing cover. Pay attention not to have the above floor plumbing cover splashed with water. If water is attached to the above floor plumbing cover, immediately wipe off the water. If water enters between the above floor plumbing cover and the floor, the above floor plumbing cover and/or the floor may be corroded.
 Do not use the above floor plumbing cover in a broken condition. Should the above floor plumbing cover be broken, contact the nearest distributor or us, and replace the broken cover. If you keep using the cover in the broken condition, an accident may result.	 Do not expose the above floor plumbing cover to shocks. Do not expose the above floor plumbing cover to shocks.

Precautions on use	
 Pay attention to the step of the above floor plumbing cover. The above floor plumbing cover has a height of 160 mm from the floor. Pay attention not to stumble on the cover when walking. Failure to follow this instruction may cause you to stumble and fall, possibly leading to injury.	 If a chemical attaches to the above floor plumbing cover, immediately wipe it off. If a chemical, such as hair color, attaches to the above floor plumbing cover, immediately wipe it off. Failure to follow this instruction may cause the cover to become stained and make it impossible to clear the contamination. Also, when a chemical attaches to the floor, immediately wipe it off.
 Avoid direct sunlight and excessive heat. Failure to follow this instruction may cause the above floor plumbing cover to become discolored.	 After using the above floor plumbing cover, be sure to wipe off any water on it. If the above floor plumbing cover with the water is left untouched, the above floor plumbing cover and/or the floor may become corroded.
 Do not wipe the above floor plumbing cover with chemical or heat the cover. Failure to follow this instruction may cause the cover to become deteriorated or deformed. Should a chemical spill on the above floor plumbing cover, immediately wipe it off.	 Do not hit an object against the above floor plumbing cover or kick it. Do not hit a hard object against the above floor plumbing cover or kick it. Failure to follow this instruction may cause the above floor plumbing cover to become deformed or broken.
 Do not drop a heavy object on the above floor plumbing cover. Do not place or drop a heavy object on the above floor plumbing cover. Failure to follow this instruction may cause damage to the cover, such as scratches and cracks.	