

# YUME SWING for Reverse Slide Layout Operating Manual

## ■ Yume Swing (Reverse Slide Layout Spec.)

- Basin Unit  
EX-YMSBXYM2 (Yume Basin, Reverse Slide Spec.)
- SWING Arm  
EX-YMSAF2 (Front Layout, Reverse Slide Spec.)  
EX-YMSAR2 (Rear Layout, Reverse Slide Spec.)
- Plumbing Cover  
EA-YMSPK2 (Wall mounted plumbing, Reverse Slide Spec.)  
EA-YMSPY2 (Under the floor plumbing, Reverse Slide Spec.)  
EA-YMSPU2 (Above the floor plumbing, Reverse Slide Spec.)

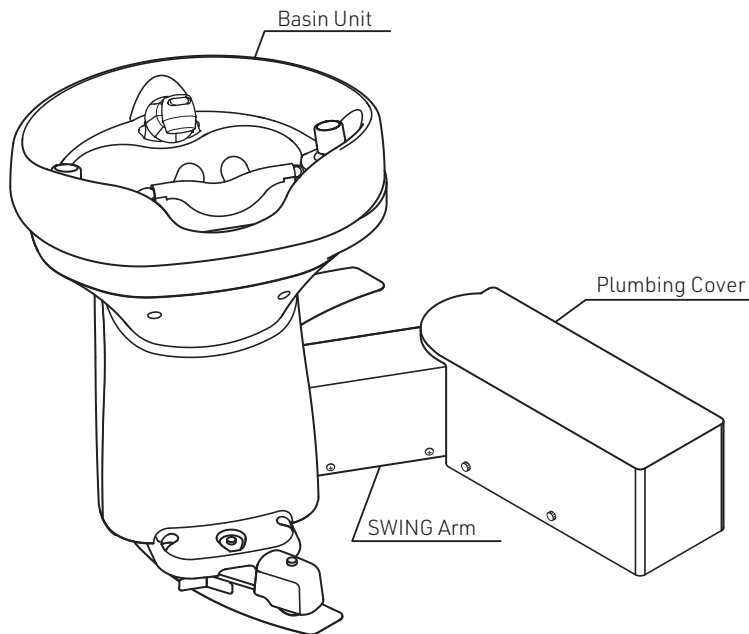

(Image is of EX-YMSBXYM2/EX-YMSAR2/EA-YMSPY2)

This product is designed for shampooing and hair/scalp care.  
Please contact the nearest dealer or Takara Belmont directly in case  
your operating manual is unreadable due to being soiled or ripped.

### Table of Contents

Description of Warning Symbols	2
Safety Precautions	2
Precautions for Use	5
Position of Warning Labels	8
Name of Parts	8
Accessories	9
Precautions for Basin	9
Before Using This Product	9
Precautions for Resin (Plated) Parts	10
Types of Layout and Standard Positions	11
Preparation	12
How to Use	14
Guiding Clients	17
Care and Maintenance	23
Daily Inspections	30
Before Requesting Repairs	30
Parts Replaced on a Regular Basis	31
Standard Duration of Use	31
Consumable Supplies	31
Disposing of This Product	32
After-sales Service	32
Specifications	32
Dimensions	33
Procedures for Daily Inspections	34

Thank you for purchasing this Takara Belmont product.

**The instructions contained in this operating manual should be thoroughly read and understood before use.**

Using this product before reading this manual may result in an accident. This product is an industrial shampoo unit designed for hairdressing salons.

Only use this product for its intended purpose and do not use it for non-hairdressing work.

Keep this manual and refer back to them when required.

# Description of Warning Symbols

## Before using this product

The "Safety Precautions" and "Precautions for Use" contained in this manual should be thoroughly read and understood before use.

## Precautions listed here

The precautions listed here are to ensure that this product can be used safely, and to prevent any danger or risk to the person using this product or those around them. These precautions are important for ensuring safety. Adhere to these precautions at all times. Takara Belmont is not responsible for any damage or risk to the person using this product or those around them due to accidents if this product is used without adhering to the "Safety Precautions" and "Precautions for Use". In this case, the person failing to adhere to the "Safety Precautions" and "Precautions for Use" will be responsible for any damage or risk incurred. Detailed descriptions of symbols are provided below. Read and understand these symbols thoroughly before reading this manual.

## Symbols



**Warning**

If this symbol is ignored and the product is used, "there is the risk of death or serious injury".



**Caution**

If this symbol is ignored and the product is used, "there is the risk of light or moderate injury or physical damage".

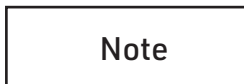

**Note**

Description of "ideal points to adhere to for safety".



Common danger, warning and caution notifications



Common prohibited actions



Guidance or instruction regarding common user actions



Disassembly Prohibited

Prohibited disassembly or repairs/modifications



CAUTION Hot water

Notification of high temperature warning

# Safety Precautions (Adhere to these precautions at all times)

## Warning



### Check and make sure that there are no people or objects around the chair

It may cause pinching accident or breakage of the basin unit. If the basin unit runs on the object, and abnormal sound is heard, or rotation of the arm becomes abnormal, stop using the product immediately and contact the nearest dealer or Takara Belmont directly.



Disassembly Prohibited

### Disassembly and repairs/modifications are prohibited.

Disassembly, repairs and modifications must not be conducted by people other than qualified repair technicians. Failure to follow this instruction may cause water leakage or abnormal operation, leading to injury.

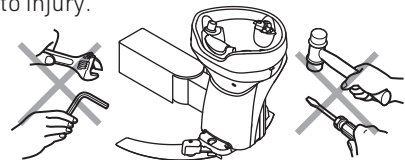

### Do not insert hands into movable

Do not insert hands into movable parts of the rotation arm. Failure to follow this instruction may cause injury.

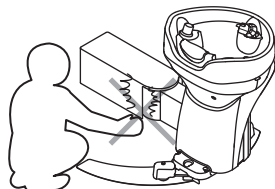

### Do not climb on basin or arm.

Do not climb on, lean on or apply excessive force to parts such as the basin, arm, etc. Failure to follow this instruction may damage the product or cause it to fall over.



## Warning



### Do not lean on the basin.

Leaning on the basin while shampooing etc., may cause the basin to fall over or rotation arm to move, leading to injury.  
Also, coloring dyes on the neck cushion or basin may stain the user's clothes.



### Adjust the water temperature while checking the temperature by hand.

When adjusting the temperature of the water, reduce the volume of water, point the shower head away from the client and check the temperature by hand. Take care when doing so, as hot water may come out of the shower head.



CAUTION  
Hot Water

### Do not use hot water (boiling water) of 60°C or higher.

Using hot water of 60°C or higher may deform or damage the basin, shower head and tap, etc.



### Return the thermostatic control knob to an appropriate position after using hot water.

- Return the thermostatic control knob to an appropriate position after using hot water at high temperature. Continuing to use the hot water with the knob in the hot temperature position may cause burns.
- Using other equipment that share the same water/hot water supply source at the same time may cause unstable water temperature. If multiple equipment are to be used, turn the thermostatic control knob slowly to adjust the water temperature.



### Install on a stable area.

Install the main unit on a flat, firm floor, and fix it securely. Failure to follow this instruction may cause the main unit to fall over.

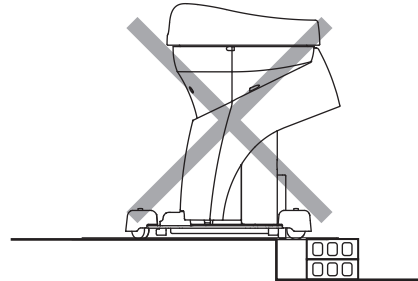

## ! Caution



### Take care when handling the shower hose.

- When using the basin unit, check that the shower hose is not trapped around feet or under the stool, etc. Failure to follow this instruction may cause damage to the basin unit.
- Do not step over the shower hose to use it. Failure to follow this instruction may cause you to tumble, leading to injury.

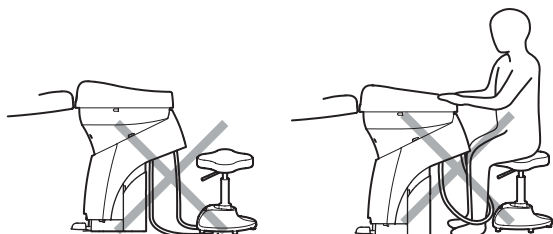

### Only use this product for its intended purpose and do not use it for non-hairdressing work.

This product is an industrial product designed for hairdressing salons. Only use this product for its intended purpose and do not use it for non-hairdressing work.



### Do not replace the caster by yourself.

Do not replace the casters by people other than qualified repair technicians. Failure to follow this instruction may cause breakage of the product or injury.



### Do not use this product with the cover broken.

Contact the nearest dealer or Takara Belmont directly to replace the cover if it breaks. Continuing to use this product with a broken cover may cause malfunction or accident.



### Do not use outdoors.

This product is designed for indoor use. Do not install this product outdoors or within a vehicle. Be sure to only use this product inside a hairdressing salon. Failure to follow this instruction may cause malfunction or damage to the main unit.



### Do not turn the water fully on with the shower head in the shower head holder.

Failure to follow this instruction may cause water to spill out of the basin, covering the client with water. When turning the water on with the dual function shower head in the shower head holder, check the surrounding area and turn the tap slowly.



### Do not subject the unit to shocks.

Do not subject the unit to shocks. Failure to follow this instruction may cause damage, leading to injury.

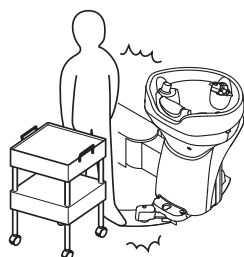

### Do not spray areas other than the basin with water.

- Take care not to spray areas other than the basin with water. If water does come in contact with areas other than the basin, wipe them dry as soon as possible. Water entering the main unit may cause degradation of the product.
- Take care not to allow water to drip on the floor. If water does drip on the floor, wipe it dry as soon as possible. Failure to follow this instruction may damage the floor or cause water leakage.



### After use, wipe water away from all parts other than the basin.

Leaving the main unit with water on it may cause breakage of the product, or dirt may become hard to remove.



### Do not use this product if the coating is peeling.

If the coating of the tap (cap of the tap) is peeling, immediately contact the nearest dealer or Takara Belmont directly and replace it. Failure to follow this instruction may cause injury.



### Do not use the product in a place where freezing is expected.

Failure to follow this instruction may result in breakage of parts, thus resulting in water leakage. Repair of breakage due to freezing will result in fees being charged even during the warranty period. If freezing is expected, maintain the room temperature at higher than 0°C by using a heater, etc.



### Do not drink the water.

This product is designed for washing hair. Do not drink the water. Depends on the water quality, it may cause diarrhea or stomach pain.

# Precautions for Use

## ⚠ Caution



### Do not wipe with chemicals or apply heat.

Failure to follow this instruction may cause deformation or discoloration. If chemicals adhere on to the covers, wipe them dry as soon as possible.

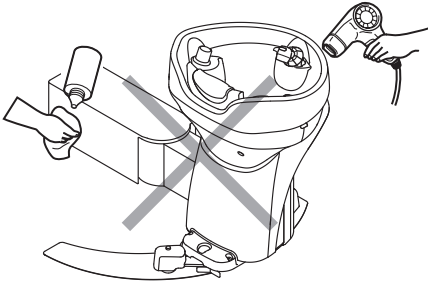

### Close the tap firmly.

After use or shampooing is complete, turn the tap firmly in a clockwise direction and turn the water off completely. Failure to turn the water off completely may cause water leakage.



### Do not cover the drain outlet when this product is not going to be used.

Do not cover the drain outlet with the drain cap, towel, or shampoo cloth after finishing the work. Water may overflow the basin when hot water/water is improperly discharged or a small amount of hot water/water is discharged due to an increase in water pressure during the night, resulting in water leakage.

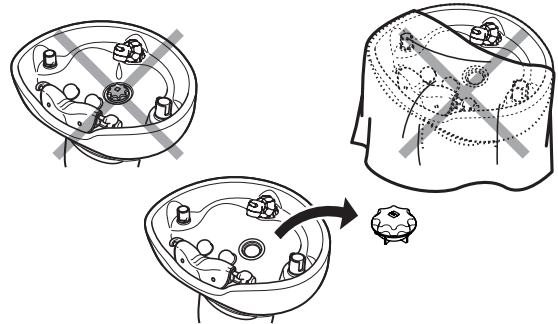

### Do not use strongly acidic or strongly alkaline cleaning solvents.

Do not use cleaning solvents containing mainly caustic soda (NaOH) or caustic potash (KOH) to clean the drain pipe, etc. Never pour thinners, alcohol, nail polish remover, gasoline or kerosene into the drain. Failure to follow this instruction may cause breakage of the drain hose.



### Do not touch the hot water supply pipe or mixing pipe.

The hot water supply pipe or mixing pipe may become very hot. Do not touch the pipes directly.



### Clean the hair catcher regularly.

Clean the hair catcher as regularly as possible. Continuing use of the hair catcher without cleaning it may cause the drain to become blocked with hair, leading to water overflowing or unhygienic conditions. Try to clean the hair catcher after each shampoo.



### Avoid direct sunlight or excessive heat.

Failure to follow this instruction may cause discoloration or degradation of the product.

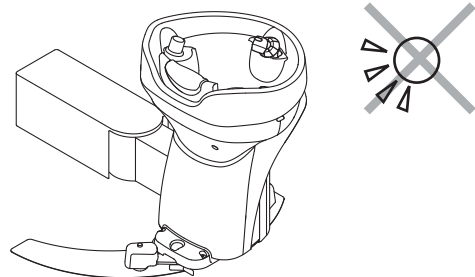

### Return the dual function shower head to the shower head holder so that the water spray nozzle faces the basin.

Failure to follow this instruction may cause water to spill out of the basin or splash on the client with water.



### Always wipe the floor clean if it is wet.

Wipe the floor as soon as possible if it is wet after shampooing. Failure to follow this instruction may damage the floor or cause degradation to parts in contact with the floor.



### Set the water temperature for this product to 80°C or less.

Failure to follow this instruction may cause malfunction or breakage in parts such as the stop valve, check valve, flexible pipe and thermostat water valve.

## Caution



### **Do not leave the dual function shower head immersed in water.**

If pressure in the water pipes decreases due to repairs that follow water stoppages, the water in the basin may flow back through the shower head.



### **If chemicals spill on to this product, wipe them away as soon as possible.**

If chemicals such as hair dyes spill on to this product, wipe them away as soon as possible. Failure to follow this instruction may cause discoloration, deterioration or deformation. Also, if chemicals spill on to the floor, wipe them away as soon as possible.

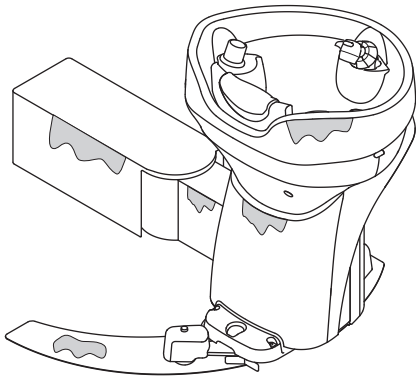

### **Do not hit the cover with objects, or kick the cover.**

Failure to follow this instruction may cause malfunction or accident, leading to damage to the main unit.

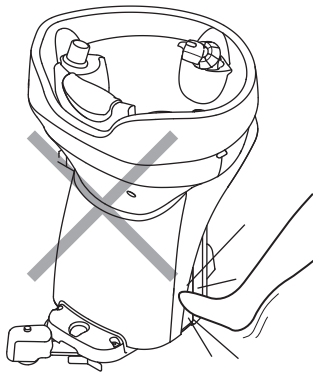

### **Do not drop heavy objects on to the basin.**

Do not place or drop heavy objects on to the basin. Failure to follow this instruction may cause breakage such as scratches or cracks on the basin.



### **Do not hit the main unit with objects.**

Do not hit the main unit with hard objects. Failure to follow this instruction may cause deformation or breakage of the main unit.



### **Do not wet the shower head holder with water.**

Do not wet the shower head holder with water. Failure to follow this instruction may cause water leakage.

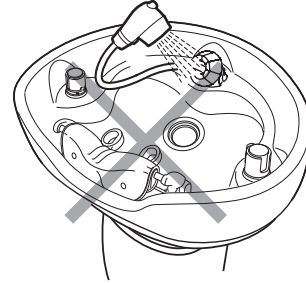

### **In cold regions, ensure that water is removed.**

When using this product in the cold regions, open the maintenance cover and open the check valve filter to remove water and prevent freezing. Failure to follow this instruction may cause water leakage.

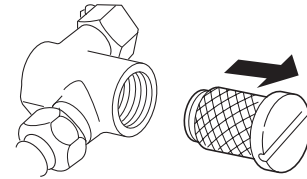

### **Do not use an abrasive compound.**

Do not use an abrasive compound to clean the dual function shower head, shower head holder, cover, etc. Use of an abrasive compound, sponge with abrasive compound, or hard cleaning tools such as wire wool or nylon scrubbing brush may cause scratches on the surface.



### **Always use the neck cushion.**

Using this product without neck cushion may apply unnecessary load to the client's neck, causing injury. Always use the neck cushion.



### **Always support basin by hands, when sliding the basin unit in the area of the initial position or the shampooing position.**

Basin unit is locked at the initial position and the shampooing position. (Slight click is felt.) While sliding the basin unit, hold the basin by hands and lock the chair gently in the area of the initial position and shampooing position. If the basin unit is moved swiftly and it hits the lock point, it may cause breakage of the product or injury.

## Caution



### Do not slide the basin swiftly.

Slide the basin gently, paying attention to avoid hitting people or objects.  
When it is slid over its limit, rotation is locked.  
When the product is locked (Slight click is felt.), do not apply excessive load to the product.

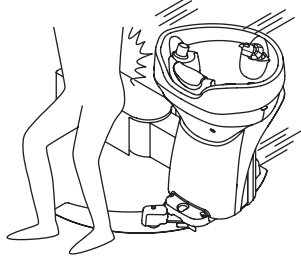

### Check the position of the basin and SWING arm before rotating the chair.

Depends on the fixed position of the chair, foot footrest will hit the basin unit, resulting in breakage of the chair or the basin unit.

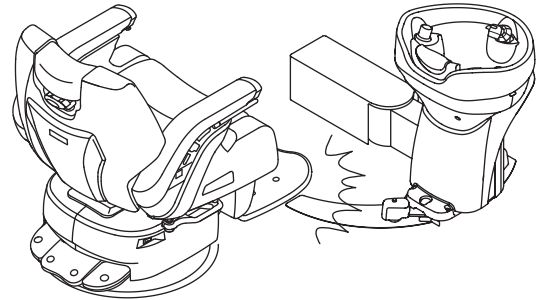

### If water spills on to the cover of SWING Arm or caster rail, wipe them dry as soon as possible.

If water spills on to the rotation arm cover, plumbing cover or caster rail, wipe them dry as soon as possible. Failure to follow this instruction may cause degradation of the parts.

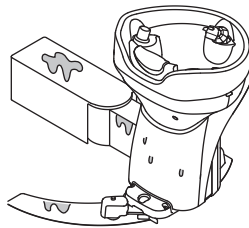

### Do not use pepper mint or aroma oil.

Do not use pepper mint or aroma oil containing menthol. Failure to follow this instruction may cause breakage of the resin parts such as shower head, shower head holder, shower hose, tap, thermostatic control knob, neck cushion, neck base, neckrest fittings, hair catcher, drain cap, etc.



### Do not hit the top of resin (plated) parts with a hard object.

Do not hit the resin (plated) parts such as tap and thermostatic control knob (top) with a hard object. Failure to follow this instruction may cause scratches or cracks on the plated surface, thus causing peeling of plating, resulting in injury.



### Do not practice front wash.

This product is intended for side wash and back wash. Practicing the front wash may cause water leakage, thus wetting the floor.



### Pay attention to handling of the neck cushion.

Do not touch or hit the neck cushion with a cutting tool such as scissors, or an edged tool (including long nails). Failure to follow this instruction may cause scratches on the surface or breakage of the neck cushion.



### Do not remove the cover of holder forcibly.

Failure to follow this instruction may cause damage to the product.



### Put shower head securely into the holder.

Failure to follow this instruction may cause water to spill out of the basin, covering the customer with water.



### Do not collect water until it overflows from the shower hose slot.

The amount of water should be below the designated maximum water level. [Page 16]

# Position of Warning Labels

<b>⚠ CAUTION</b>	<b>⚠ CAUTION</b>	<b>⚠ CAUTION</b>
Do not use hot water of 60°C and higher. Using hot water at 60°C and higher may deform or damage the ceramic bowl, the shower head or the faucet handle.	If chemical such as hair dye attached to the equipment, wipe it out immediately, or it may cause discoloration or deterioration.	Do not use chemical detergent mainly containing caustic soda (NaOH) & caustic potash (KOH) for cleaning drain pipes, etc. This may cause damage on the drain hose, etc.
<b>For other cautions, please read the operating instruction carefully before use.</b>		

<b>⚠ CAUTION</b>
The drain cap must be detached from the drain outlet when the product is not in use.

<b>⚠ 警告 WARNING</b>
ここに手を入れないでください。はさまると、大きなケガをするおそれがあります。 <b>PINCHING</b> DO NOT insert finger or hand into this space. Serious injury may occur by pinching.

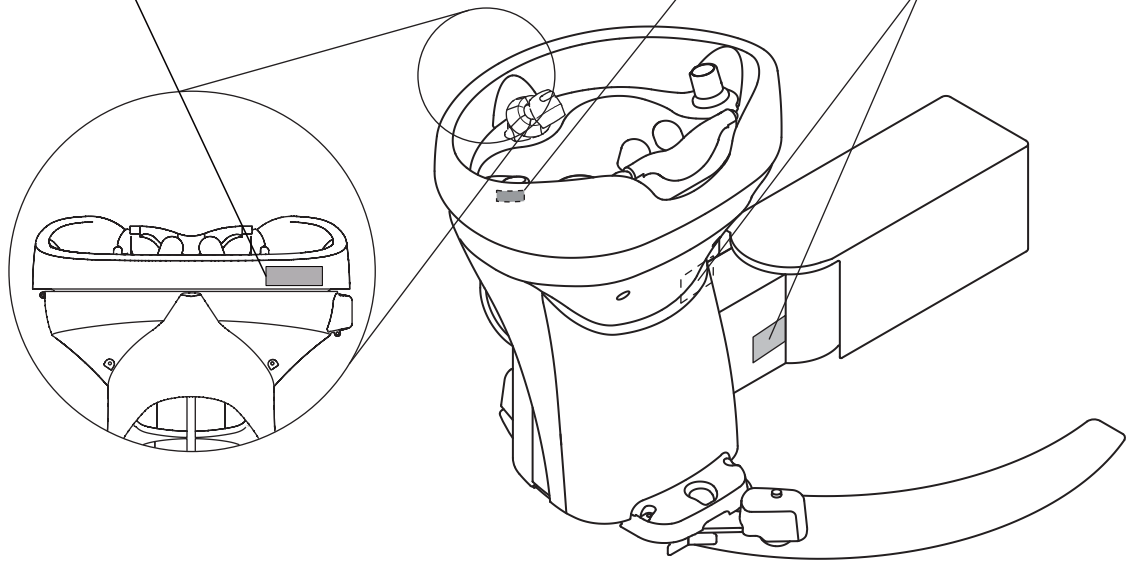

# Name of Parts

<YUME Basin>

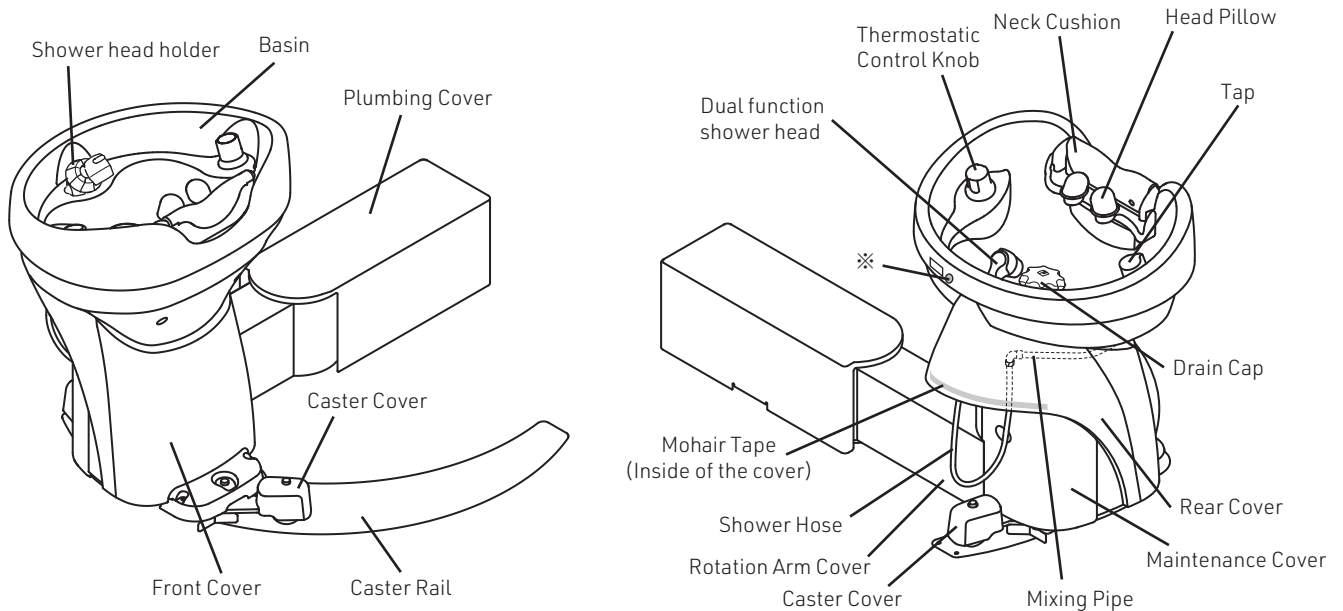

## Note

- Protrusion and depression surface may be found on the basin shown in the ※ part of the above illustration. Since this cannot be avoided when forming the basin and this is not a product failure.
- The external cover is made from resin. Since line or color difference cannot be avoided when manufacturing the part, and these are not a product failure.



# Accessories

\* Confirm that all of the following parts are coming with product

Mohair Tape (Spare) (1)



Hair Catcher (1)



Sponge (1)



Drain Cap (1)



Neck Cushion (1)

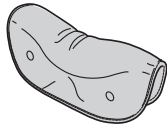

Head Pillows (1 pair)

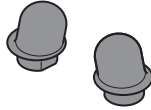

Operating Manual (1)

Installation Manual (1)

"Mohair tape" Manual (1)

YUME SPA Technical Manual(except for China)(1)

## Precautions for Basin

- This product employs a ceramic basin. Since bending or deformation cannot be avoided when forming the basin, please note that the neck position, height, or shape differs slightly from product to product.

## Before Using This Product

- Yume Basin is a wash unit designed for performing back wash※1 and hair/scalp care.
- For more comfortable shampooing, recommend to use ESPOIR stool (Sold separately. Product code: ES-ESST) with Yume Basin for performing seated shampooing※2 and hair/scalp care.
  - ※1 Back wash : the user stands behind the basin and performs shampooing from the back (rear position).
  - ※2 Seated Shampooing : the user seats on the stool, etc. and performs shampooing from the back (back position)
- Check that all accessories have been attached properly.
- Caster rail is to prevent floor from getting scratched while the caster of basin unit slides. Please note in advance that surface of caster rail may degrade due to its original feature after continuous use.
- Please note in advance that the gap of the cover may differ slightly from product to product.
- There is a gap between basin and cover. This is because the basin is made of ceramic and this is not faulty product.
- Please note in advance that the gap between chair backrest and basin when reclining the chair backrest may vary slightly from product to product.

# Precautions for Resin (Plated) Parts

- Resin plating is used for the tap and the thermostatic control knob.
  - Plating is a thin and hard metal film applied to the surface that may crack or peel due to corrosion or aged deterioration.
  - Scratches or cracks may occur on the plated surface due to impacts from falling objects.
  - Scratches or cracks may occur on the plated surface when a hard object hits the surface.
  - Peeling of the plating may occur from scratches or cracks on the plated surface.

## Caution

Check to ensure that there are no scratches, cracks, or peeling of the plated surface of the tap, etc. before using the product. If peeling is observed, immediately stop using the product and contact the nearest dealer or Takara Belmont directly. Continued operation may result in injury.

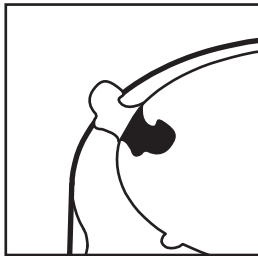

Example of peeling of the plated surface

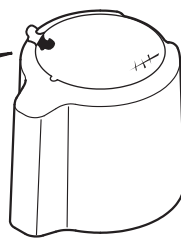

Example of scratches on the plated surface

# Types of Layout and Standard Positions

There are two types of layout for this product, "Front Layout" and "Rear Layout".  
Check the "Initial Position" and "Shampooing Position" from the illustrations shown below.

## ■ Front Layout

<Initial Position>

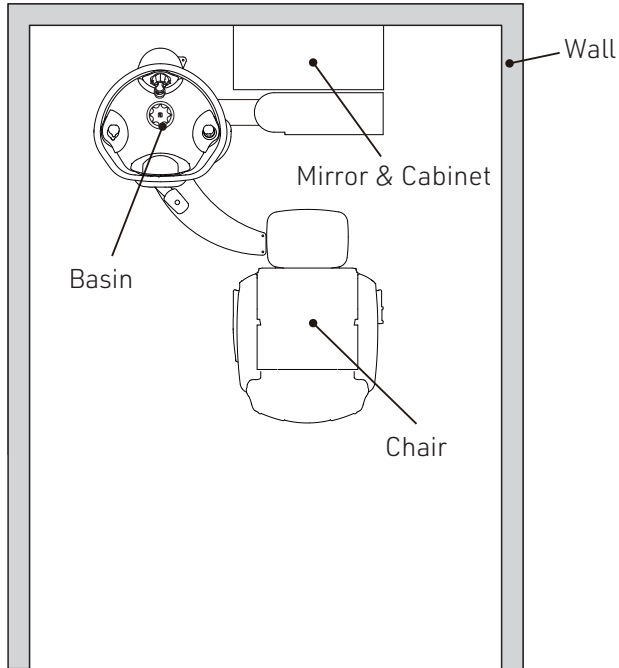

<Shampooing Position>

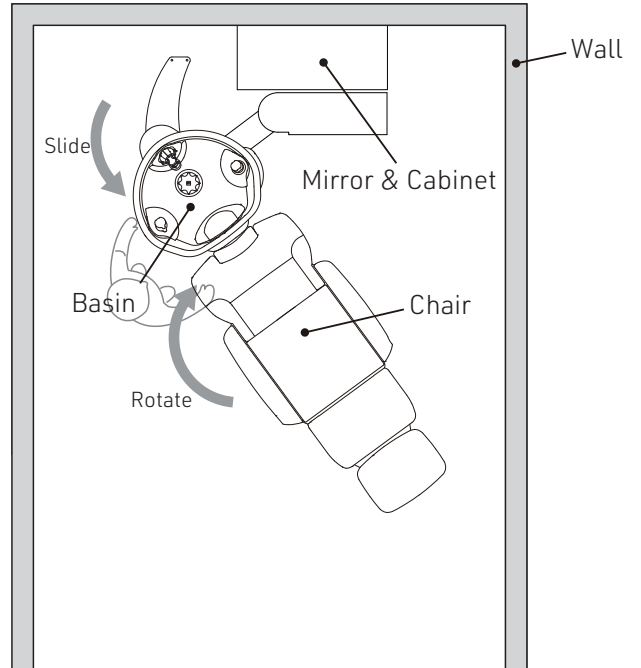

## ■ Rear Layout

<Initial Position>

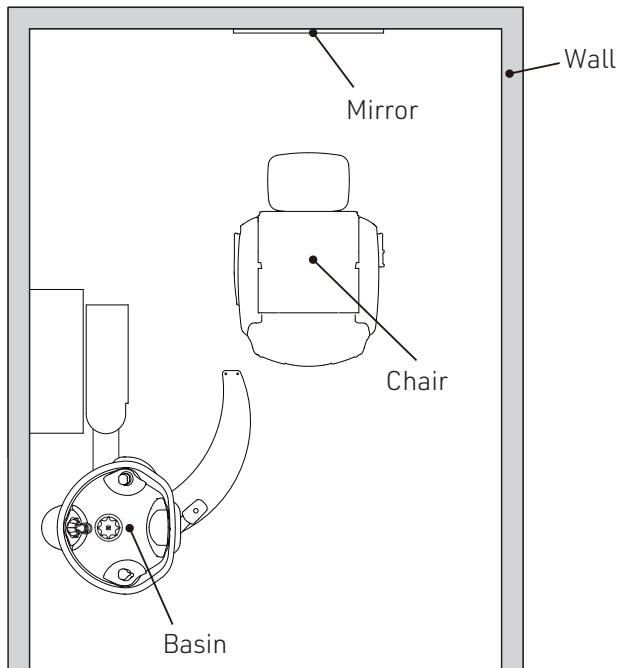

<Shampooing Position>

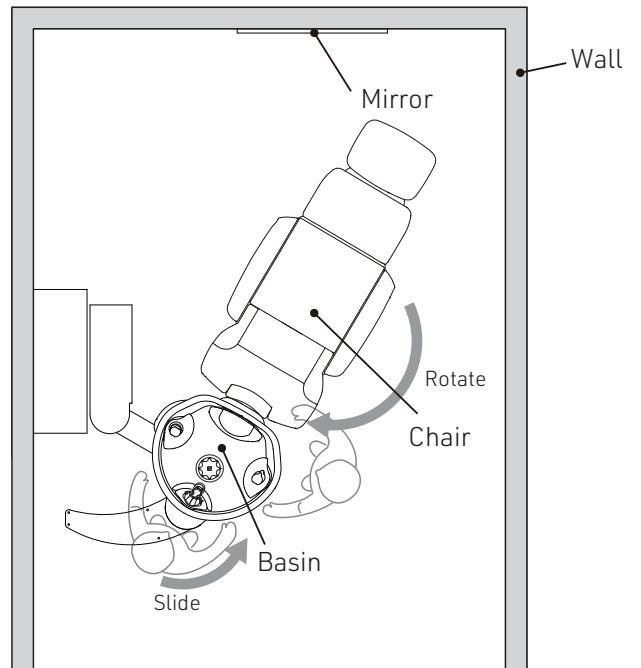

# Preparation

## ■ Attach neck cushion

- 1 As shown in the illustration, check the proper direction of the neck cushion and fit it to the metal fittings. (Pay attention to the proper direction.)

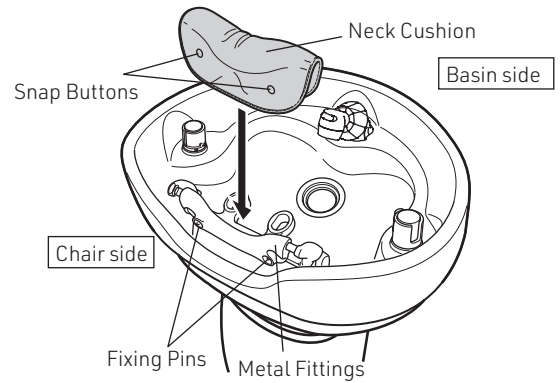
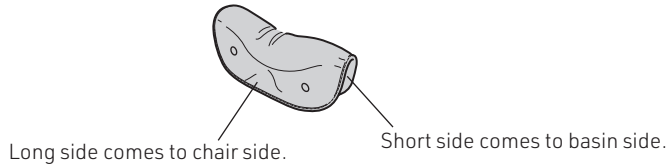

- 2 Secure the snap buttons of neck cushion on the chair side to the fixing pins of metal fittings.



The fixing pins are detachable.  
Be careful not to lose them.

- 3 While shaping the neck cushion along the metal fittings, secure the snap buttons of the neck cushion to the fixing pins on the basin side.

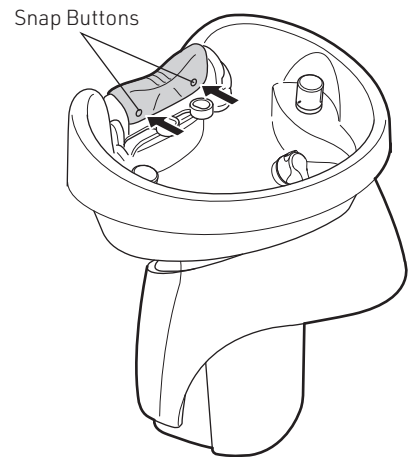
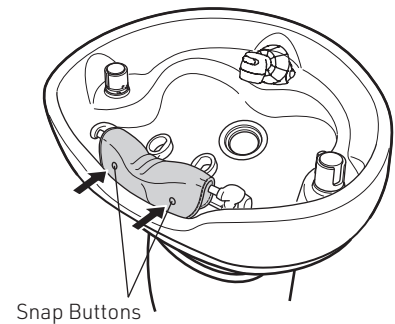

## ■ Remove neck cushion

Detach the snap buttons (4 locations) and remove the neck cushion.



### Caution

Applying excessive force to remove the neck cushion may break the parts.

## ■ Attach head pillows

As shown in the illustrations, check the proper direction of the head pillows and insert them into the metal fittings.

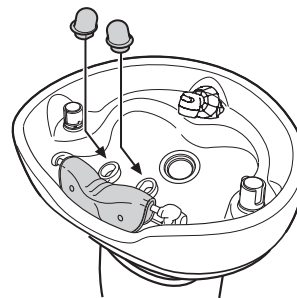
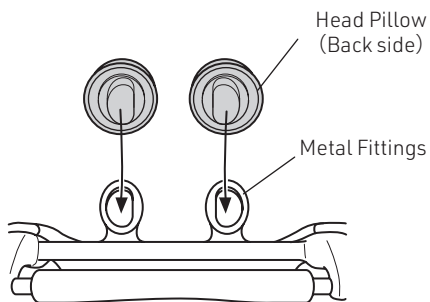

### Note

The neck cushion and head pillows are consumable supplies. Replace them if they are extremely dirty or the surface has deteriorated. (available at additional cost)  
To replace the neck cushion and head pillows, contact the nearest dealer or Takara Belmont directly.

## Remove the Cover

- 1 Turn the cover counterclockwise.  
Turn the cover around 5 degrees.
- 2 Pinch the front and back of the cover to deform and remove the catch.

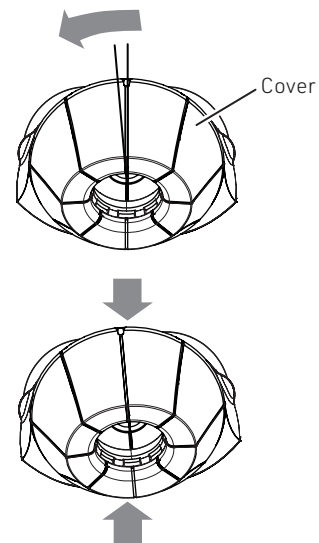
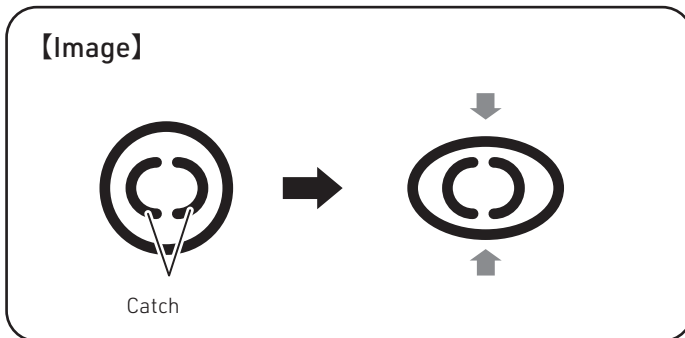

### **Caution**

Do not remove the cover of holder forcibly.  
Failure to follow the instruction may cause damage the product.

## Sponge Installation

Attach the sponge to the shower hose.  
Attach the sponge and sponge holder to the shower hose, between the shower head holder and the cover.

### **Caution**

Ensure that the harder side of sponge is facing upwards.

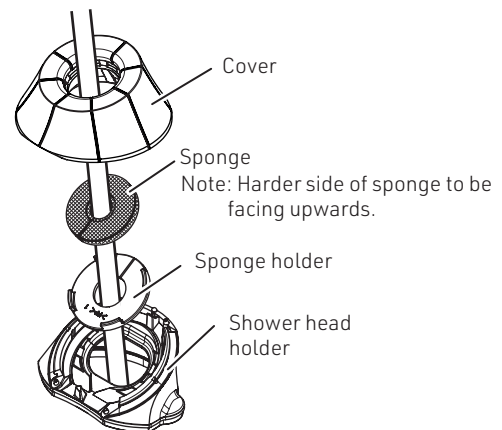

## Installation of the Cover

Align groove in the cover and protrusion of the holder until they snap into place.

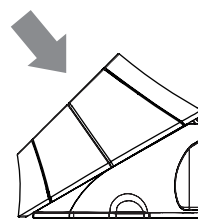
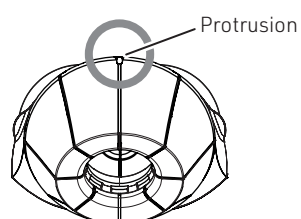

# How to Use

## ■ Using the dual function shower head

Shower water discharge and air foaming water discharge are selectable with pressing the selection switch.

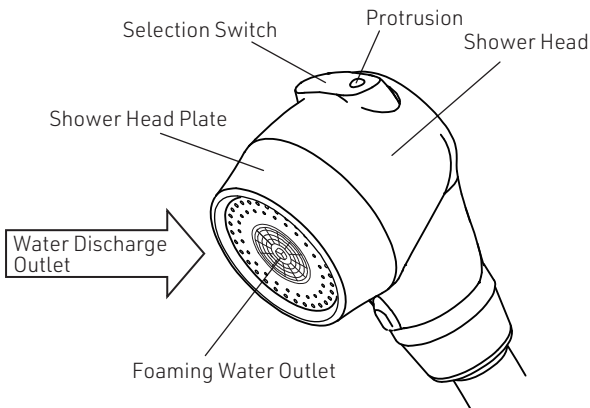

### <Shower Mode>

- Press the switch on the side with the protrusion.



### <Low Splash Mode>

- Press the switch on the flat side.



## ⚠ Caution

- Do not discharge a strong water stream when the shower head is in the shower head holder. Failure to follow this instruction may result in product malfunction due to spilled water or damage to the floor.
- Return the shower head to the shower head holder after use so that the shower head plate is pointed toward the basin.

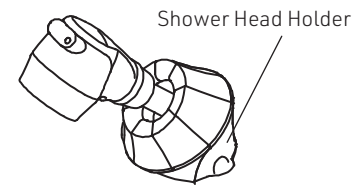

## ■ Adjusting the volume of water

A left (counter clockwise) rotation of the tap increases the amount of hot water. A full left (counter clockwise) rotation of the tap (approximately 130 degrees) will output the maximum amount. A full right (clockwise) rotation of the tap will stop the water.

(The illustration shows Side Basin)

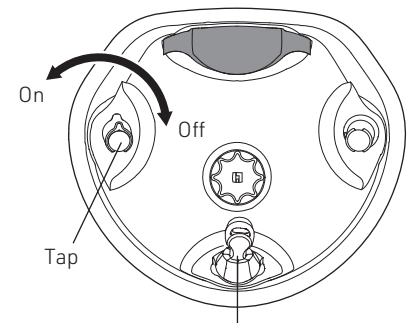

Dual function shower head

## ⚠ Caution

- When the basin is not being used, turn the tap firmly full right (clockwise) to turn the water off properly. Failure to do this may cause water leakage.
- After shampooing, do not cover the drain with the drain cap, towel or shampoo cloth, etc. If the hot water may come out accidentally or hot water is trickle due to an increase in water pressure at night, this may cause water to spill out from the basin, leading to water leakage.
- If the drainage becomes sluggish, immediately stop using the product, and contact the nearest dealer or Takara Belmont directly. The drain pipe may be clogged with dirt, resulting in water leakage of the inside of the product.
- Operate the tap only after removing metallic objects, such as rings and wrist watches, etc. Failure to follow this instruction may result in contact between the metal and the cap of tap resulting in scratches or cracks on the plated surface and thereby causing peeling of the plating.
- Before using the product, check that there are no scratches, cracks, or peeling of the plated surface of the tap. If the plating is peeled off, immediately stop using the product and contact the nearest dealer or Takara Belmont directly. Continued operation may result in personal injury.

## Note

Depends on the environment or condition that it is used in, the product may have the following conditions. If adjustment or replacement is required, contact the nearest dealer or Takara Belmont directly.

- A gushing sound may be emitted from the basin unit. (Adjustment is required.) This sound is due to water flowing fast through pipes as a result of high water pressure or water volume control, and is not indicative of a defective product. This gushing sound may be reduced by adjusting the water pressure.
- The tap may become stiffer. (Replacement is required.)  
This is due to deterioration of gasket of movable parts or a lack of grease as a result of aging. Replacement of the gasket or other parts, or a recoating of grease is required. (available at additional cost)

## ■ Adjusting the water temperature

- 1 Turn the thermostatic control knob in the H or C direction to set the temperature to an appropriate level.

When turning to the H direction, water becomes warm, and when turning to the C direction, water becomes cold.

### ⚠ Caution

- When adjusting the water temperature, reduce the volume of water, point the shower head away from the client and check the temperature by hand. Take care when doing so, as hot water may come out of the shower head.

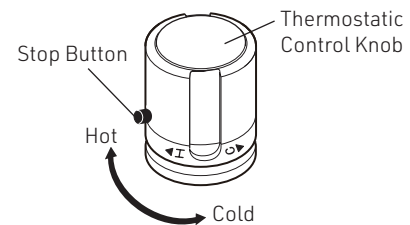
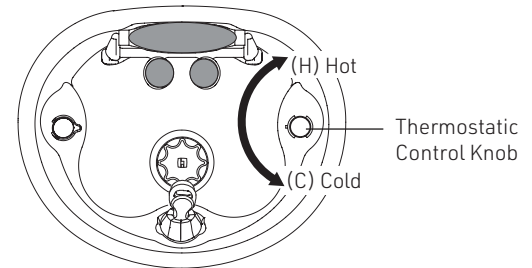

- 2 To use hot water at high temperature (40°C and higher), turn the thermostatic control knob in the H direction while holding down the stop button.

### ⚠ Caution

- Return the thermostatic control knob to an appropriate position after use. Continuing to use the hot water with the knob in the hot temperature position may cause burns.
- Using other equipment that shares the same water/hot water supply source at the same time may cause unstable water temperature. Do not execute any quick operation while adjusting the temperature.
- Operate the thermostatic control knob only after removing metallic objects such as rings and wrist watches, etc. Failure to follow this instruction may result in contact between the metal and cap of thermostatic control knob resulting in scratches or cracks on the plated surface and thereby causing peeling of the plating.
- Before using the product, check that there are no scratches, cracks, or peeling of the plated surface of the thermostatic control knob. If the plating is peeled off, immediately stop using the product and contact the nearest dealer or Takara Belmont directly as it may result in personal injury. Continued operation may result in personal injury.

\*For safety reasons, this product is designed so that hot water of approximately 53°C or higher is not output.  
(Conditions: In the case that the supply pressure of water and hot water are the same, normal water temperature is 20°C and hot water temperature is 60°C.)

## Note

- Depends on the operating environment or conditions, the water discharge amount may change significantly when controlling the hot water temperature. This phenomena occurs when the hot water temperature exceeds the recommended values (60°C to 80°C), there is significant difference in the water supply or hot-water supply pressure, or multiple devices are used at the same time – it is not a product failure.
- The temperature of discharged water and the preset temperature may differ depending on the operating environment or conditions.  
(The product is designed so that the temperature of the discharged water will be about 40°C when the thermostatic control knob is turned toward the H position and locked in that position.)  
This phenomena occurs when the hot water temperature exceeds the recommended values (60°C to 80°C), there is significant difference in the water supply or hot-water supply pressure, or multiple devices are used at the same time - it is not product failure. The temperature of discharged water may be set at approximately 40°C when the temperature of hot water or the pressure of the water/hot water supply is adjusted and the locking position of the thermostatic control knob is adjusted.

## ■ To fill up basin with hot water

To fill the basin with water, rotate the drain cap in the clockwise direction to close the drain outlet.

The amount of water should be below the level shown by the dotted line in the illustration below (just below the shower hose slot).

When water accumulates and exceeds the dotted line, water may overflow from the shower hose slot.

To drain the water, rotate the drain cap in the anticlockwise direction to open the drain outlet.

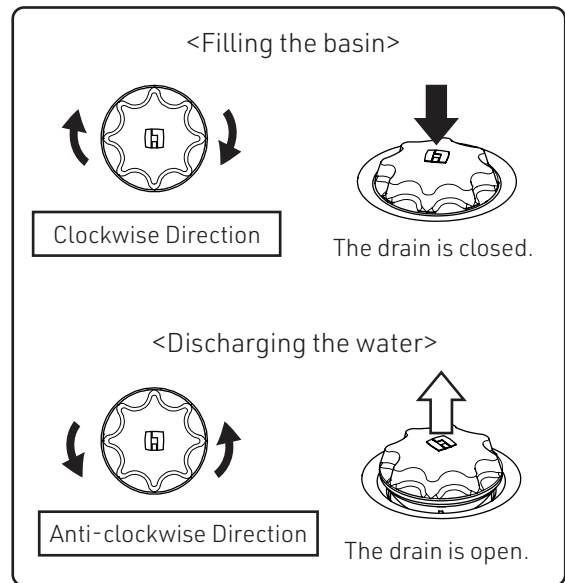
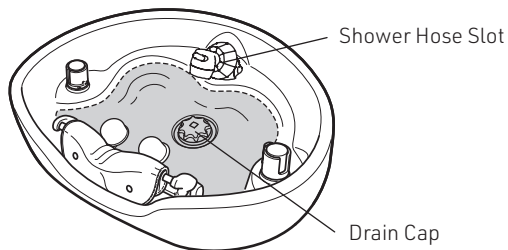

### Caution

- The amount of water should be below the designated maximum water level. (See right figure.)
- Do not leave the shower head in the water to ensure that water doesn't leak out the shower hose slot. Water may flow back into the water pipe which could cause issues.
- When the drainage speed slows, there is a possibility that dust and dirt may have clogged the drainpipe.
- The drain cap must be detached from the drain outlet when the product is not in use. If the drain cap is not detached, the drain may accidentally close, and the water may overflow from the failure to notice water dripping, thus resulting in water leaks.

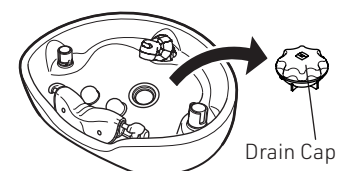
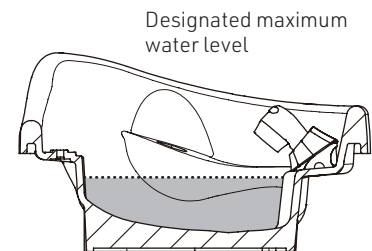

### Note

The amount of accumulated hot water may decrease slightly in an amount that does not affect use. A small amount of water may flow out, but does not affect its convenient use. If the decreasing level is significant, the gasket of the drain cap may have deteriorated or become worn, so replace the drain cap. (available at additional cost)



# Guiding Clients

## ■ Specifications of this product

There are 2 combinations available for this product.

Front Layout	YUME basin
Rear Layout	YUME basin

## ■ Sliding the basin unit

When sliding the basin unit, hold the edge of the basin and slide it. Basin unit is locked at initial position and at shampooing position. Slight click is felt when the basin is locked.

### ⚠ Caution

When sliding the basin unit, hold the basin with both hands and lock the basin gently around the areas of initial position and shampooing position. If the basin unit is moved swiftly and it hits the lock position, it may result in breakage of product or personal injury.

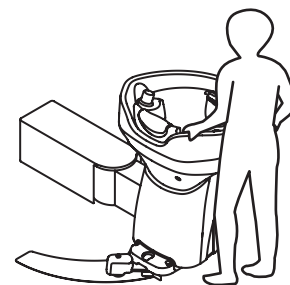

## <When shampooing>

1 Check if the chair and basin unit return to the initial position properly.

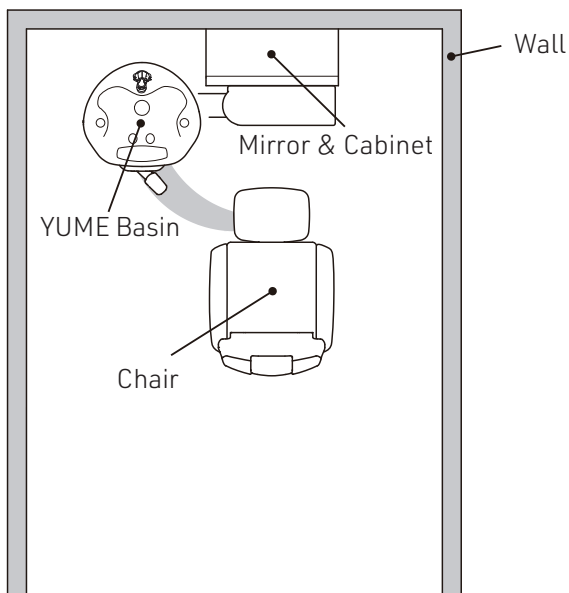

<Image of Front Layout>

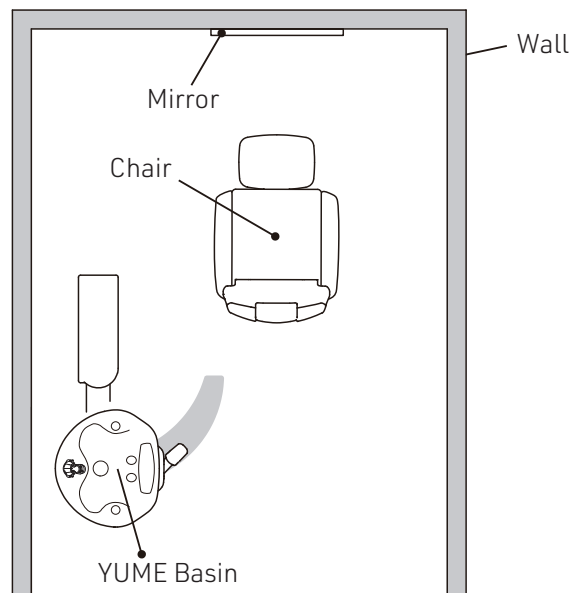

<Image of Rear Layout>

"Initial Position"

2 Ask client to seat on the chair and apply shampoo cloth.

Recommended product: Shampoo cloth without water dropper (hood)

\*In case of using shampoo cloth with water dropper (hood), insert the water dropper into the gap between basin and chair backrest.

**3** Unlock the chair rotation after the client seats on the chair, and rotate it to the shampooing position.

\*Refer to the Operating Manual of each chair to know how to unlock the chair rotation.

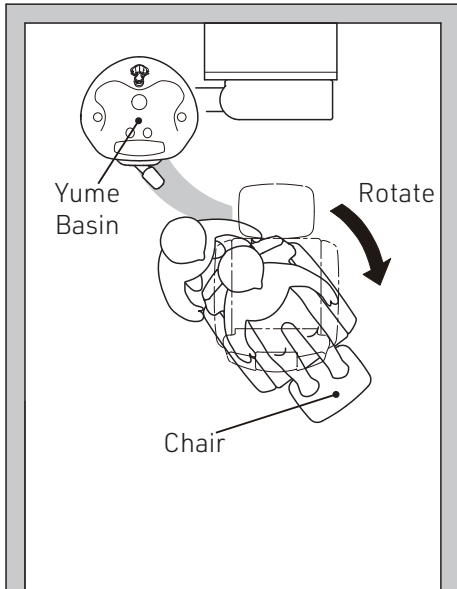

<Image of Front Layout>

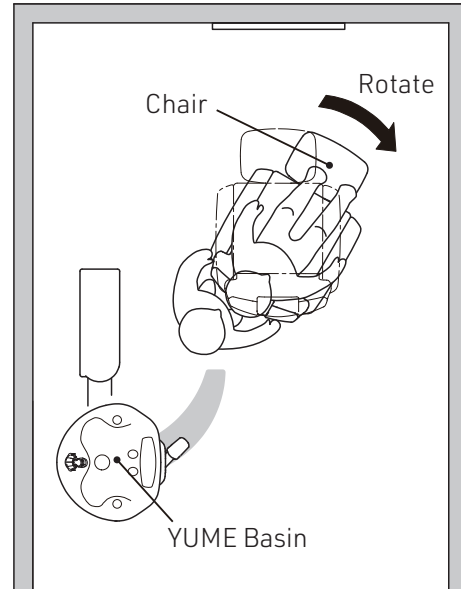

<Image of Rear Layout>

**Note**

Chair rotation position to be set align with the seals attached to the chair base and lower cover.

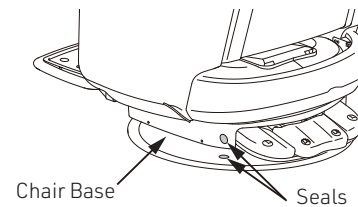

**4** Slide the basin unit to shampooing position and lock it.

\*Slight click is felt when the chair is locked.

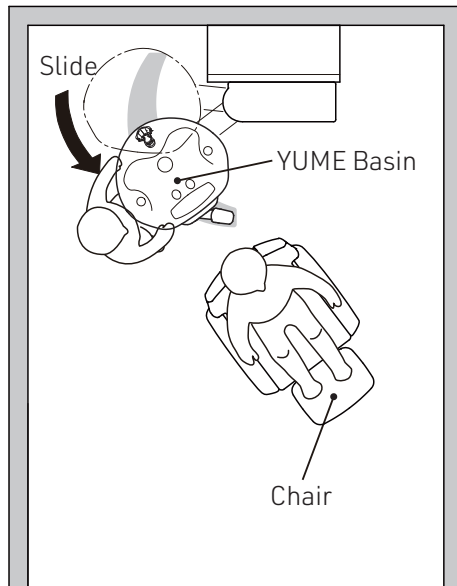

<Image of Front Layout>

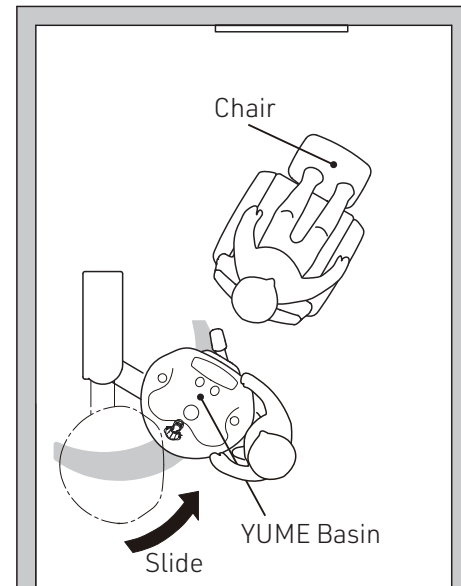

<Image of Rear Layout>

**Caution**

When sliding the basin unit, hold the basin with both hands and lock the basin gently around the area of initial position and shampooing position. If the basin unit is moved swiftly and it hits to the lock position, it may result in breakage of the product or personal injury.

5 When reclining the backrest of the chair, support client's head by your hand.

\*Refer to the Operating Manual to know how to recline the chair backrest.

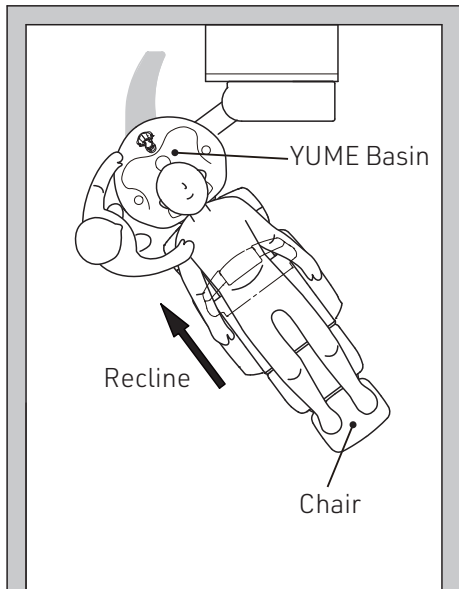

<Image of Front Layout>

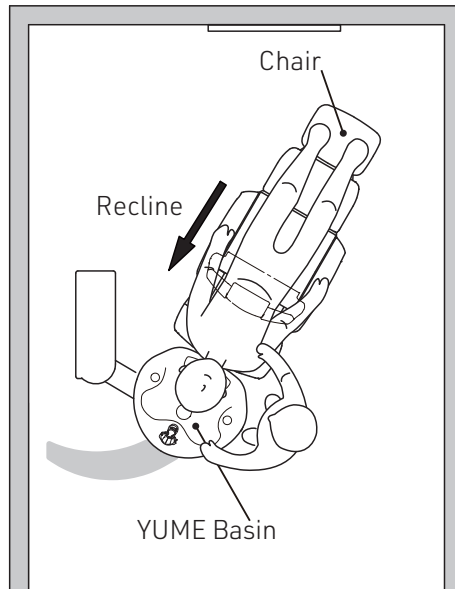

<Image of Rear Layout>

**Note**

The appropriate gap between backrest of the chair and the basin is 15mm.

\*Chair at the maximum height

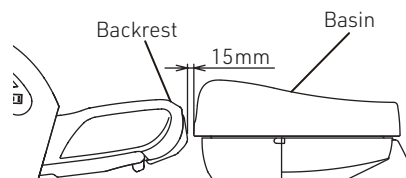

**Caution**

When reclining the backrest, hold the client's head by your hand to avoid client's head to hit the basin.

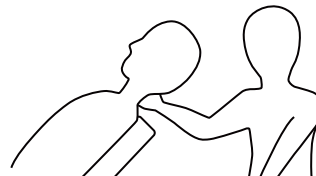

6 Check if the chair align with the basin.

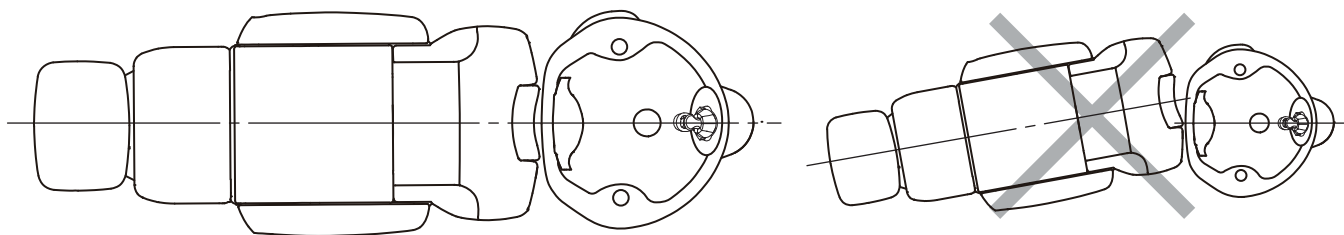

7 When necessary, unlock the chair rotation and adjust it so that it becomes into an alignment with the basin. After adjustment, lock the chair rotation again.

**Warning**

- When unlocking the chair rotation while the client is laying on the chair to do this small adjustment, be sure to hold the client's head by hand. Rotating the chair without holding the client's head with hand may result in personal injury to the client.
- After adjusting the chair, be sure to lock the chair rotation again before performing shampooing. With the chair unlocked, chair may rotate, resulting in personal injury to the client.

8 Check that the client's face angle is horizontal.

If this is not the case, ask the client to move upward or downward in order to adjust the face angle.

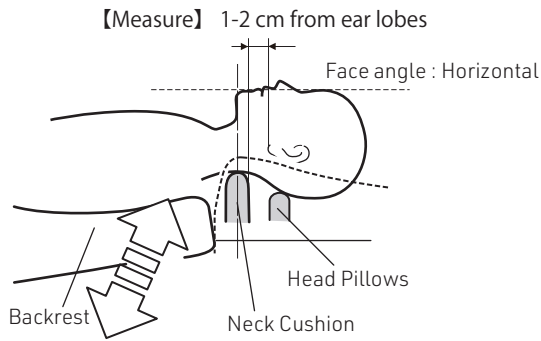

9 When necessary, move the chair upward or downward in order to adjust the backrest height.

\*Refer to Operating Manual of each chair to know how to raise and lower the chair.

10 Shampooing, etc.

### Shampooing style

#### <Back Wash (Seated Shampooing) >

The user sits behind the basin and performs shampooing from the back.

\*Recommend to use at Rear Layout.



ESPOIR Stool

For performing seated shampooing, please use the exclusive ESPOIR Stool.  
(Sold separately, Product code: ES-ESST)

#### <Adjusting the height of ESPOIR Stool>

1. While seating on the stool, raise the handle and release the lock.
2. Adjust it to the desired height.
3. Return the handle and lock the stool.

For the details, refer to the Operating Manual supplied with the stool.

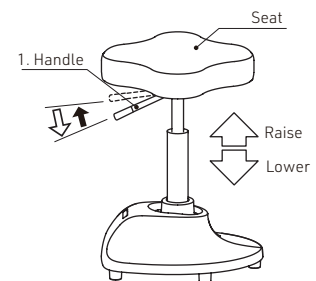

11 After shampooing, raise the chair backrest while supporting the client's head by your hand.

12 Hold the edge of the basin and slide basin unit to the initial position.

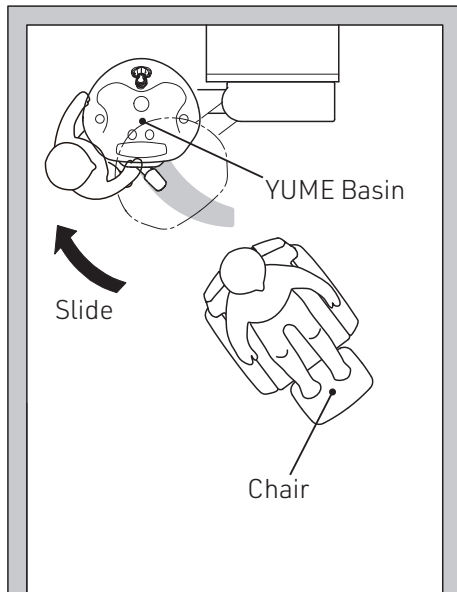

<Image of Front Layout>

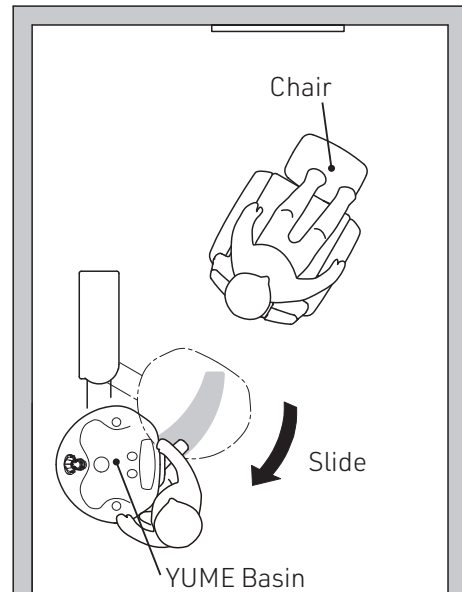

<Image of Rear Layout>

### ⚠ Caution

- When sliding the basin unit, hold the basin with both hands and lock the basin slowly around the area of initial position and shampooing position. If the basin unit is moved swiftly and it hits the lock position, it may result in breakage of product or personal injury.
- When returning the basin unit, return it to the initial position completely. Failure to follow this instruction may allow the basin unit to contact to chair, etc., resulting in product breakage.

13 Unlock the chair rotation, rotate it to the center of mirror, and lock the chair rotation.

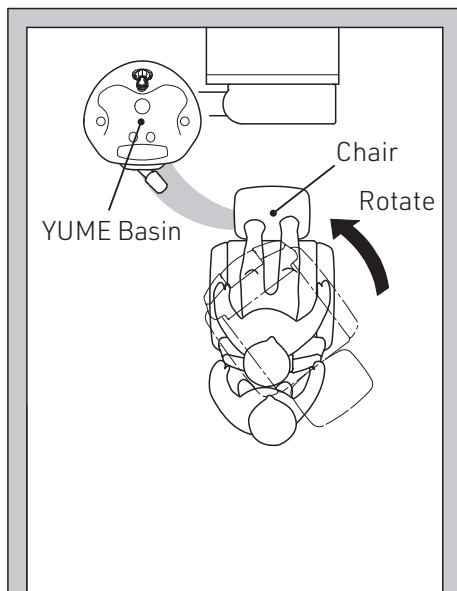

<Image of Front Layout>

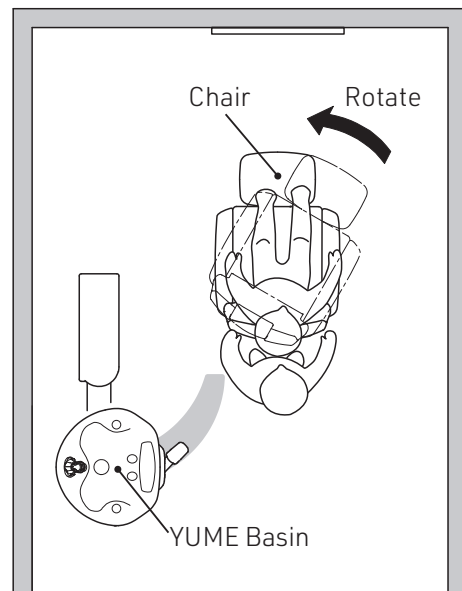

<Image of Rear Layout>

### ⚠ Warning

- After confirming that the chair is returned to the initial position properly and chair rotation is locked, allow the client to stand up from the chair. If the client stands up when the chair is unlocked, it may cause the client to fall down, resulting in personal injury or product malfunction.
- When lowering or rotating the chair, confirm that there is no people or objects around the chair. Especially, care must be taken to small children.
- When raising and lowering the chair, confirm that there is an enough space between client's feet and front wall, etc.

14 After shampooing, wipe off any moisture.

<Moisture attached to the basin cover and external parts of the basin>



<Moisture dropped on the floor through shower hose>

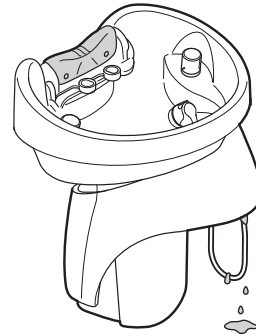

<Moisture attached to the rotation arm cover, plumbing cover and caster rail>

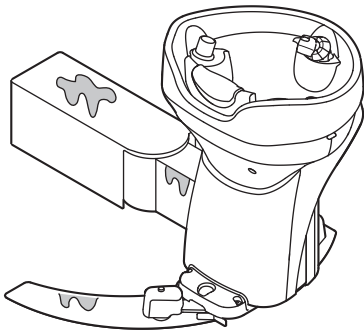

**! Caution**

After use, be sure to wipe off any moisture from all parts other than the basin. Leaving the product with water drops may result in failure of the product or any contamination will not be removed.

**! Caution**

The drain cap must be detached from the drain outlet when the product is not in use. If the lid is not detached, the lid may accidentally close, and the water may overflow the basin from the failure to notice water discharge, thus resulting in water leaks.

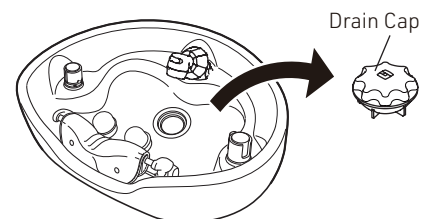

# Care and Maintenance

## Caution

Never use volatile chemicals such as thinners, alcohol, gasoline or kerosene, cleaning products such as abrasive wax, a sponge with a scourer, detergents that include organic solvents, acidic, alkaline or chlorine-based detergents, or scouring pads. Failure to follow this instruction may cause scratches or discoloration.

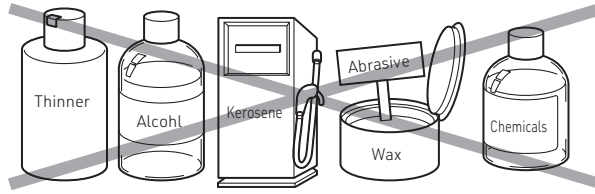

## ■ Hair Catcher

Pull out the hair catcher located under the drain cap and remove any hair that has been caught. The hair catcher is a consumable supply. Replace the hair catcher if it is extremely dirty or the surface has deteriorated. (available at additional cost)

## Caution

Clean the hair catcher as regularly as possible. Continuing to use the hair catcher without cleaning can cause the drain to become blocked with hair, leading to water overflowing and unhygienic conditions. Try to clean the hair catcher after each shampoo.

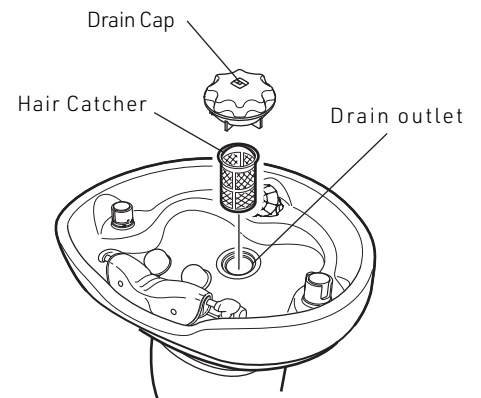

## ■ Neck Cushion, Head Pillows

At the end of work each day, wash the neck cushion and head pillows with water, wipe them dry with a towel, and allow them to dry in the shade. If they are extremely dirty, wash with detergent diluted with water, and rinse carefully with water.

The neck cushion and head pillows are consumable supplies. Replace them if they are extremely dirty or the surface has deteriorated. (available at additional cost)

## Caution

- If solvents drip onto the neck cushion or head pillows, rinse it with water as soon as possible. Failure to follow this instruction may cause deformation or discoloration.
- Clean the neck cushion and head pillows every day. Leaving dirt unclean may cause them to get moldy.

## ■ Shower head holder, Tap, Thermostatic control knob

Wipe away contamination using a soft cloth or towel that has been moistened with a dilute, neutral detergent.

## Caution

- Repeated usage of even general domestic-use sponges may damage the surface. Therefore do not use sponges.
- Abrasives, as well as sponges containing abrasives, metal scourers, nylon scourers, etc. May damage the surface. Ensure that these are not used.
- Do not use chlorine chemicals and acid chemicals because they may peel the surface plating.
- If scratching or damage appears on resin or plated parts such as the tap and thermostatic control knob, then immediately suspend use, and contact the closest dealer or Takara Belmont. Failure to suspend use may result in peeling plating or damage, leading hand injuries.

## ■Basin

Wipe any dirt clean using detergent diluted with water. If streaked scratches appear due to contact with metallic objects such as watch bands, rub the area with a nylon scourer.

### Caution

Do not use a metallic scourer or sandpaper, as this will damage the basin.

Carefully clean around the neck cushion and head cushions metal fittings with an item such as a cotton-tipped swab.

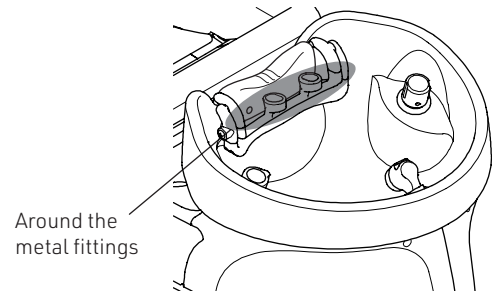

## ■Cleaning the dual function shower head (Foaming Water Outlet)

- 1 Rotate and detach the shower head plate, remove foaming water outlet and rubber gasket. (\*Do not remove O-ring.)
- 2 Clean the shower head plate with water. Using a nylon or similar brush, remove the dirt such as water stain from the holes of shower head plate.
- 3 Clean the foaming water outlet with water. Clean it once a month (measure). Using a nylon or similar brush, remove the dirt such as water stain from the foaming water outlet.

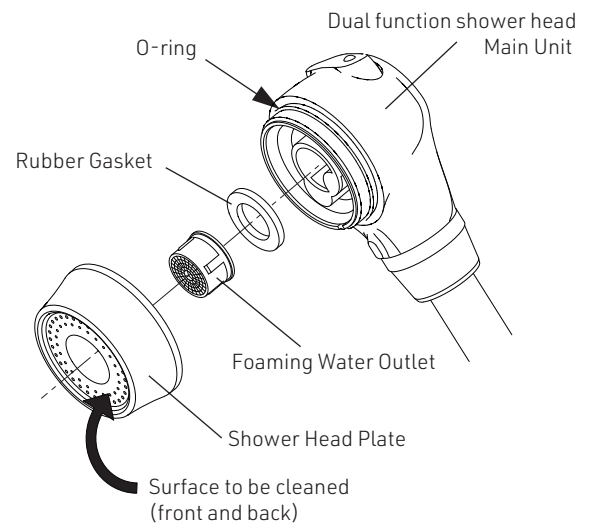
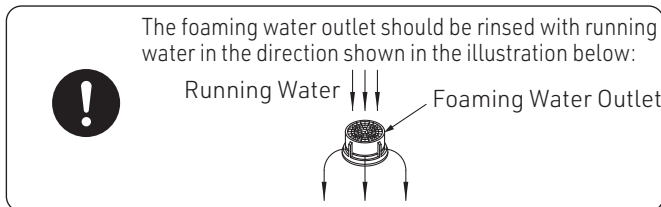

- 4 Re-assemble the shower head.

### <Assembling Procedures>

- (1) Insert the foaming water outlet and the rubber gasket in the shower head plate in this order.
- (2) Attach the shower head plate to the dual function shower head main unit. When doing this procedure, the water discharge side of the shower head plate should face down.

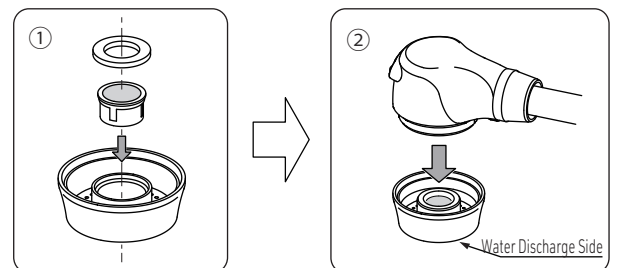



## ■Sponge

Sponge is consumable supply.  
Replace the sponge if degradation causes rubbing sound  
when the hose is moving. (Available at additional cost)  
Remove the cover from the holder. [Page 13]

- Remove the sponge from the hose and wash with water.
- After washing the sponge with water, squeeze it like pressing with both hands.
- Clean the sponge every day.
- After cleaning the sponge, put it in the hose and put it back on the cover.

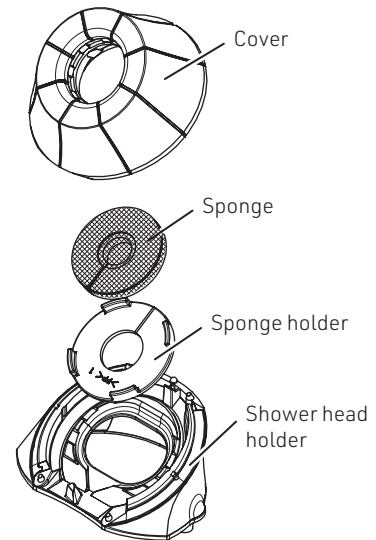

### Caution

- Please keep the sponge in the net.  
If the sponge protrudes from the end of the net, return it to the net.
- Do not twist the sponge as it may damage the parts.
- Be careful not to mistake the direction of the sponge.  
The harder side is above.

## ■Cover

Replace the cover if it easily comes off repeatedly when the hose is moving. (Available at additional cost)

[Replacement method]

- 1 Remove the shower head.  
(The figure on the right)
- 2 Remove the cover from the shower hose.  
Push the socket to remove the cover.

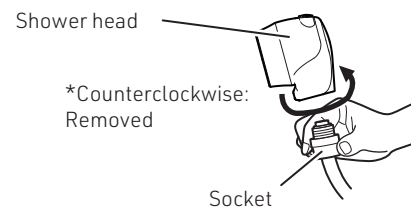

- 3 Install a new cover.

Tips for installation.  
Put the socket into a plastic bag and push the  
cover to make it easier to enter.

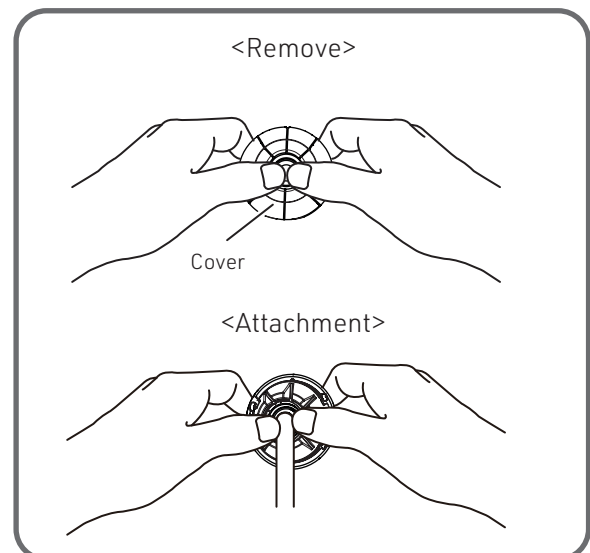

## ■Basin body

### <Drain cap>

Wash around the drain cap, and remove any hair or dirt from chemicals. The drain cap is a consumable supply.

Replace the drain cap if degradation causes water to leak quickly when the basin is filled with water.

(available at an additional cost)

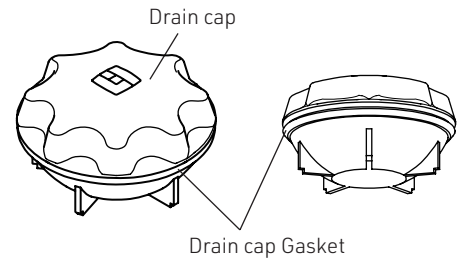

### Caution

The drain cap must be detached from the drain outlet when the product is not in use. If the cap is not detached, the cap may accidentally close, and the water may overflow the basin from the failure to notice water discharge, thus resulting in water leaks.

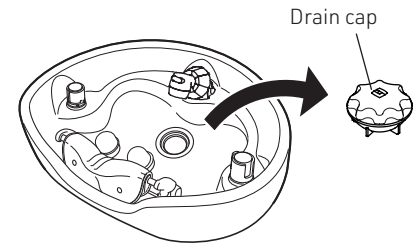

The drain cap should be handled carefully. It may break if it is dropped.



The drain cap gasket is fixed on the drain cap. If you try to remove it forcibly, the gasket may be damaged and the water in the basin may decrease at a faster pace.

### <Removing water from filter and cleaning the filter>

To use the basin for a long period of time, clean the filter (inside of the check valve) regularly.

If temperature is expected to drop below freezing in cold regions, drain the water from the check valve.

### Caution

In cold regions, always drain the water as a measure to prevent freezing. Failure to follow this instruction may cause water leakage.

### Caution

When operating water draining and cleaning procedures for the filter, pay attention water does not split to electric parts nearby. Failure to follow this caution may result in malfunction of the product or electrical leakage, resulting in fire.



When removing maintenance cover and plumbing cover, pay attention those parts will not hit the rotation arm cover.

1 Prepare cloth (two or more in A4 size) to soak up water.

2 Remove the Knurled thumb screw (1 pce. with gasket), and detach the maintenance cover.

\*Take care not to lose the Knurled thumb screw that has been removed, since it will be attached again.



After removing the maintenance cover, check that there is no water leakage inside of the basin unit. If there is water leakage, the pipes inside of the basin may be damaged. Contact the nearest dealer or Takara Belmont

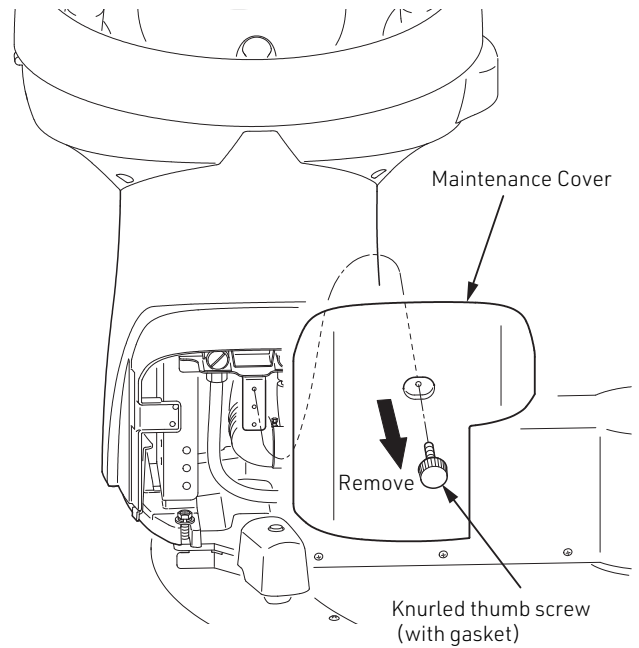

3 Detach the plumbing cover.

\*Take care not to lose the Knurled thumb screws (4 pcs.) that have been removed, since they will be attached again.

\*In case that the mirror cabinet (sold separately) is also installed, remove 2 pcs. of Knurled thumb screws.



After detaching the maintenance cover, check that there is no water leakage inside of the swing arm cover. If there is water leakage, the pipes inside of the swing arm cover may be damaged. If this is the case, contact the nearest dealer or Takara Belmont directly.

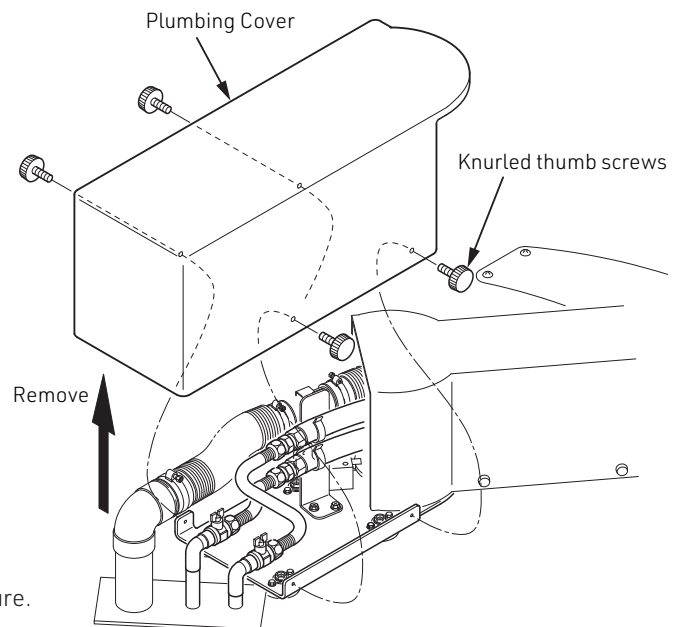

4 With cloth, cover the floor around the water and hot water supply pipes.

\*Be careful of the rotation arm cover when doing this procedure.



## Caution

- If there are electrical components such as wires nearby, ensure that water does not splash onto them. Failure to follow this instruction may cause a ground leakage fire.
- The hot water supply pipe may become very hot. Take care not to touch the pipe directly.

5 Close stop valves of the hot water and water supply pipes.



To prevent water leakage, always check that the stop valves are completely closed before executing cleaning, or draining the water from the filters.

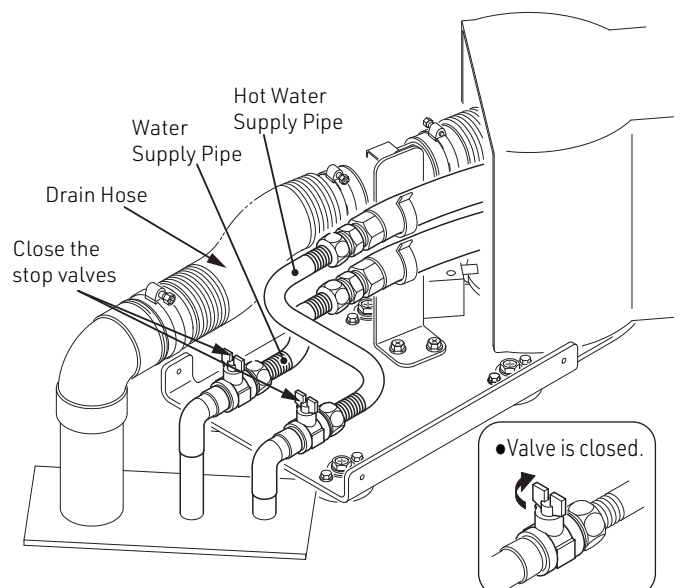

- 6 Remove the filters while holding a cloth under the check valves with filter, and remove water in the filters.

**⚠ Caution**  
 Removing the filter from the hot water supply pipe may cause hot water to spill out. Take extra care when draining the hot water.

**!** Execute these processes for both water supply pipe and hot water supply pipe.

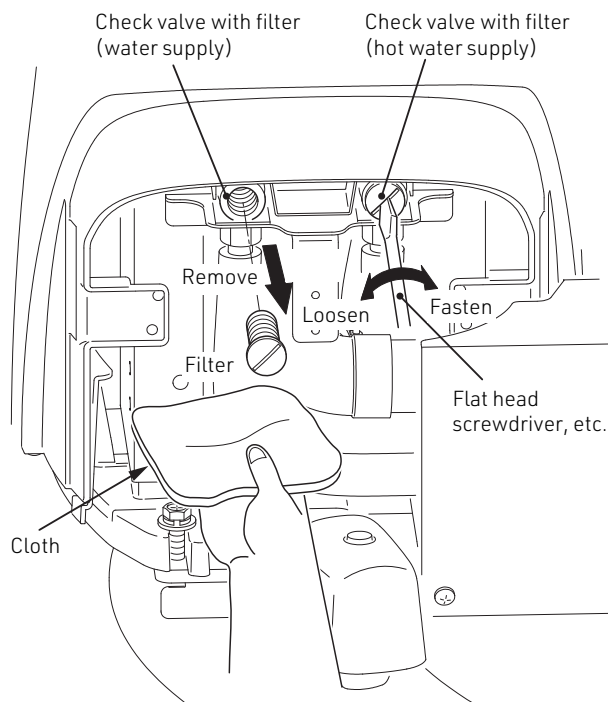

- 7 After cleaning the filters, return them to the original position and fasten them properly.

- 8 Wipe any water that has spilled, and remove the cloth used.

**⚠ Caution**

- Fasten the filters properly. Water may leak if the filters are loose.
- If waste water spills on to the floor, wipe it dry immediately.

- 9 After checking that the filters have been fastened properly, open the stop valves.
- 10 Return the plumbing cover to its original position using the Knurled thumb screw removed at the process 2.
- 11 Return the maintenance cover to its original position using the Knurled thumb screw (1 pce.) removed at the process 1.

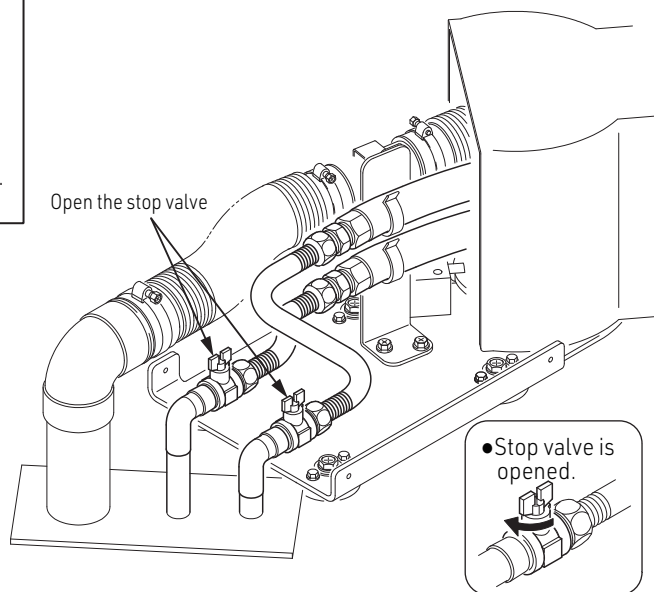

<Checking for water leakage>

Open the maintenance cover once per week (measure):

- Check that water is not leaking onto the floor.
- Check that water is not leaking on the floor where installing SWING arm.

If there is water leakage, the basin unit or pipes in the rotation arm may be damaged, so contact the nearest dealer or Takara Belmont directly.

## ■Caster

### <Cleaning the caster>

When the hair or dirt tangled with caster, and it does not move smoothly, clean the caster.

- 1 Remove the Knurled thumb screw (with gasket) from caster cover at the shower head side and neck cushion side (2 locations in total) and detach the caster covers.

#### **Caution**

Do not detach the caster. If replacement of the caster is required, contact the nearest dealer or Takara Belmont directly.

- 2 Remove hair and dirt tangled with caster, and clean it.
- 3 Return the caster cover to its original place.

#### **Note**

Caster rail is intended to prevent floor from scratches when caster moves. Subject to its original feature, after a period of use, it may cause degradation of the surface.

\* Caster and caster rail are consumable supplies. If they are extremely dirty or deteriorated, refer to "Consumable Supplies" and contact the nearest dealer or Takara Belmont directly.

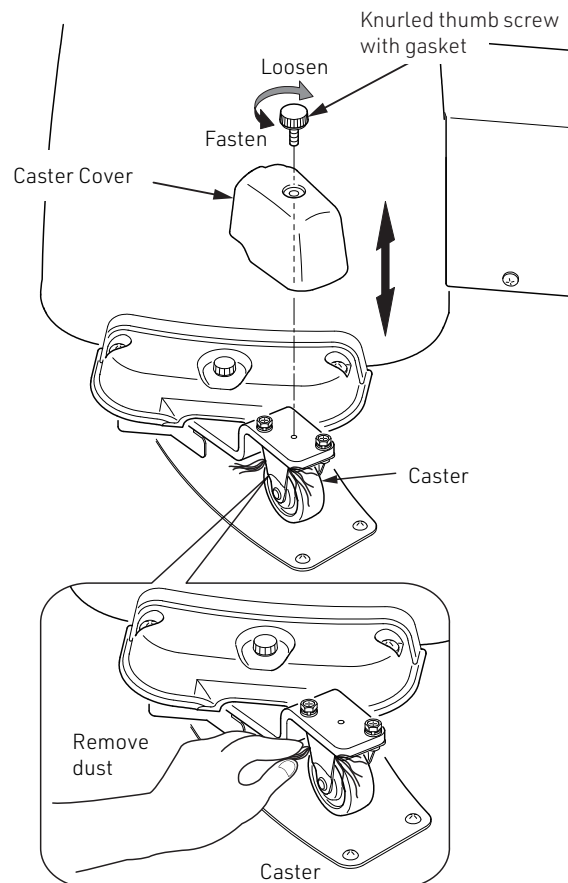

# Daily Inspections

- To ensure that this product can be used for a long period of time, follow the procedures outlined in "Procedures for Daily Inspections" on page 34 to 35 of this operating manual.



Always inspect this product following the procedures outlined in "Procedures for Daily Inspections". Continuing to use this product without performing the daily inspections may cause malfunctions or accidents.

# Before Requesting Repairs

If the following problems arise, conduct the checks outlined below, before requesting repairs.

Symptom	Check this	Solution
• Water does not come out.	→ Are the water stop valves of the pipes open? (Refer to page 28.)	Open the stop valves. (Refer to pages 26 to 28.)
• Sounds are generated when hot water is supplied.	→ Do the sounds vary when the hot water amount is adjusted at the tap?	Adjust the volume of the water. (Refer to pages 14 to 15.)
• The water temperature is low.	→ Is the temperature setup of the boiler proper?	Adjust the temperature setup of the boiler to the proper temperature.
	→ Is the temperature setup of the thermostatic control knob proper?	Adjust the temperature setup of the thermostatic control knob to the proper temperature. (Refer to page 15.)
• The water drains poorly from the drain outlet.	→ Is hair clogging the hair catcher?	Remove the hair clogging the hair catcher. (Refer to page 23.)
• The basin unit does not move smoothly.	→ Is hair tangled with the caster?	Clean the caster. (Refer to page 29.)
• The cover has come off.	→ Attach the cover. (Refer to page 13.)	Replace the cover if it easily comes off repeatedly when the hose is moving.
• When the hose is moved, it makes a sound.	→ The sponge is protruding from the end of the net.	Adjust the temperature setup of the boiler to the proper temperature.
	→ The surface of the shower hose has deteriorated and is rough. (The cover and shower hose rub and make noise.)	Replace the shower hose, if wiping the surface of the shower hose with a wet towel does not improve. (Available at additional cost)

If the product does not operate properly after checking and repairing the above points, stop using the product immediately.

# Parts Replaced on a Regular Basis

The following are parts that must be replaced on a regular basis as designated by our company:

- Drain hose: Replace every three years
  - For the drain hose, there is a possibility that water leaks will occur because cracks are caused due to deterioration and hardening of the hose from chemical agents in the drain water.
  - Damage to the hose may result in water flooding on or beneath the floor.
- Check valve: Replace every three years
  - When the check valve is used continuously for long periods of time, there is a possibility that the parts in the valve will deteriorate resulting in no water discharging, or sometimes, the sewage water once discharged from the water faucet will flow back, thus causing contamination of city water or public health problems.
- Water/hot-water supply hose: Replace every three years
  - For the water/hot-water supply hose, there is a possibility that cracks due to deterioration caused by equipment operation or residual chlorine or copper ions in the city water will cause water leaks.
  - Damage to the hose may result in water flooding on or beneath the floor.

The above-listed parts must be replaced on a regular basis to ensure and maintain safety and performance. Any part that is outside the designated replacement period must be replaced even if there is no problem during use. (The parts are available at additional cost.) Our company will not assume responsibility for any harm, damage, or defects attributed to any part that was not replaced within the designated period. For ordering replacement work, contact your local Takara Belmont dealer.

# Standard Duration of Use

The standard period of use of this product is seven years. The standard period of use is "a guide for the standard period that this product can be used properly from a safety perspective, when conducting appropriate maintenance and inspections (including replacement of parts) for the standard usage conditions for each product." This is not the same as the warranty period.

# Consumable Supplies

The following parts are "consumable supplies" and wear, degradation, changes in external appearance and damage are expected. Please note that repair or replacement of these parts is not covered by warranty, and a fee will be required. (\*The level and period of wear, degradation or damage may differ depending on the environment and conditions that the client uses this product in.)

Inspections or replacement of parts will be required if extensive wear, degradation or damage occurs.

Consumable Parts (The following parts are not covered by the warranty; the cost of replacement is your responsibility.)				
□ Neck cushion	□ Head pillows	□ Drain cap	□ Hair catcher	□ Sponge
□ Mohair tape	□ Rubber gasket, etc.	□ Shower hose	□ Shower head holder cover	
□ Dual function shower head foaming water outlet (Foaming water outlet and rubber gasket)				□ Caster
□ Caster rail	□ Lubricants (oil, grease, etc.)			

Furthermore, scratches, contamination, deterioration, and discoloration of the exterior parts listed below are not covered by the warranty.

- Exterior parts
  - Covers, frames, and basin;
  - Knobs (tap, thermostatic control knob, etc.); and
  - Other parts (Shower head, shower head holder, drain tap gasket, etc.)

# Disposing of This Product

When disposing of this product or replaced parts, adhere with current regulations and dispose them appropriately according to the law in your country.

## After-sales Service

To request after-sales service, contact the nearest dealer or Takara Belmont directly.

## Specifications

Product code	Basin Unit	EX-YMSBXYM2 (YUME Basin, Reverse Slide Spec.)	
	SWING Arm	EX-YMSAF2	(Front Layout, Reverse Slide Spec.)
		EX-YMSAR2	(Rear Layout, Reverse Slide Spec.)
	Plumbing Cover	EA-YMSPK2	(Wall mounted plumbing, Reverse Slide Spec.)
EA-YMSPY		(Under the floor plumbing, Reverse Slide Spec.)	
EA-YMSPU2		(Above the floor plumbing, Reverse Slide Spec.)	
Outside Dimensions	Refer to "Dimensions" Page 33.		
Angle of movable Rotation Arm	Front Layout	-6°~37°	
	Rear Layout	0°~60°	
Neck Height	YUME Basin	800mm	
Mixing Type	Thermostat Type		
Water discharging type / discharging amount (In case, hot water pressure/water pressure : 0.1MPa, respectively)	Dual function shower head	Shower outlet	: 10.0L / min
		Low splash foaming mode : 6.5 L / min	
Stop valve	Single faucet (rotary type)		
Operating environment	Operating temperature: 10 - 40°C		
	Operating humidity: 95% or below (No condensing)		
*Hot water supply temperature	80°C or below		
*Hot water / water supply	<ul style="list-style-type: none"> <li>▪ 0.1 - 0.4MPa (1 to 4kgf/cm<sup>2</sup>)</li> <li>▪ Water supply pressure <math>\geq</math> Hot water supply pressure</li> <li>▪ Difference between hot water supply pressure and water supply pressure: Within 0.2MPa (2kgf/cm<sup>2</sup>)</li> </ul>		
Weight	EX-YMSBXYM2 + EX-YMSAR2 + EA-YMSPY		61kg

\*For details of the hot water supply temperature, hot water/water supply pressures, see the Yume Swing installation manual for reverse slide layout.



# Dimensions

## <Overview Diagram>

\*The illustrations show the spec. of H height and under the floor plumbing.

[Unit: mm]

### ■ Front Layout

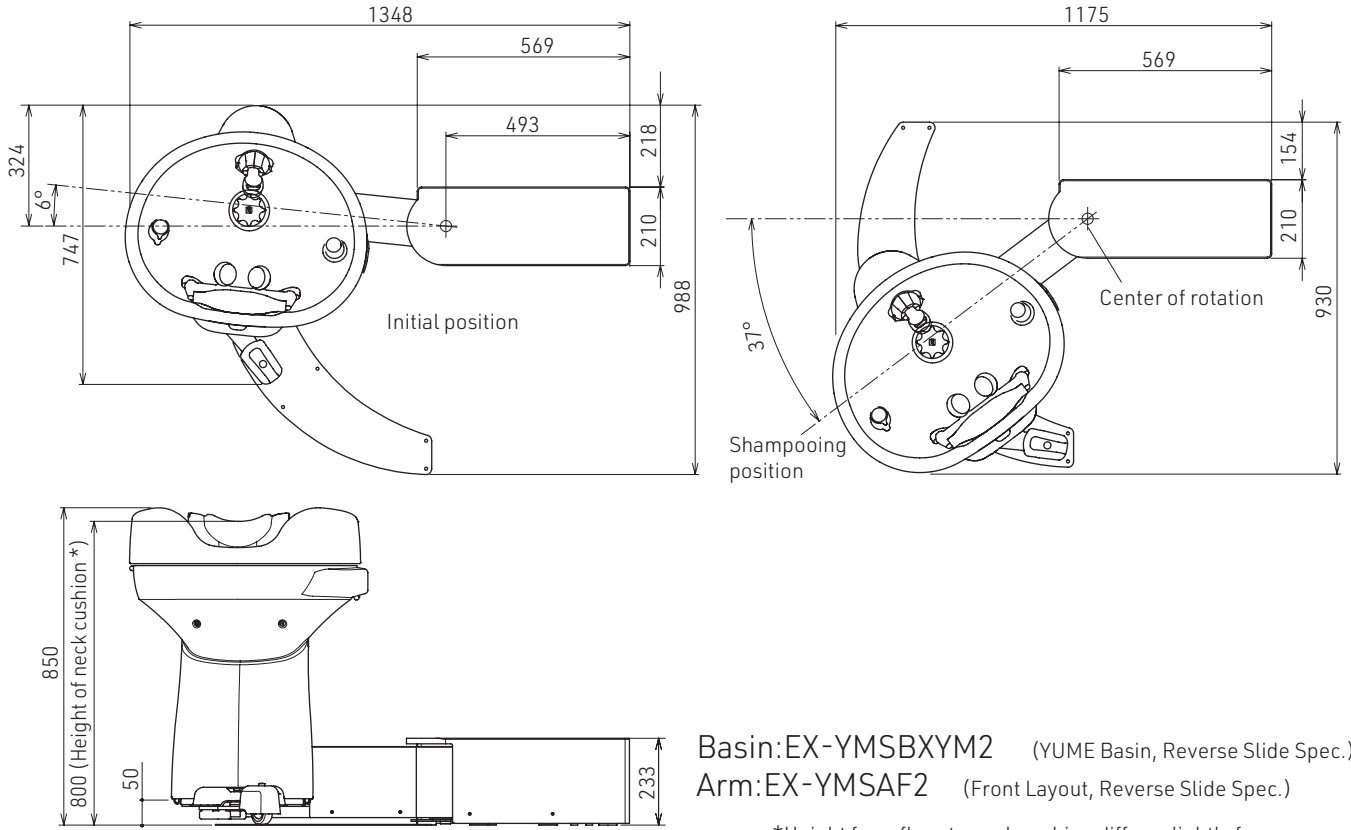

\*Height from floor to neck cushion differs slightly from product to product.

### ■ Rear Layout

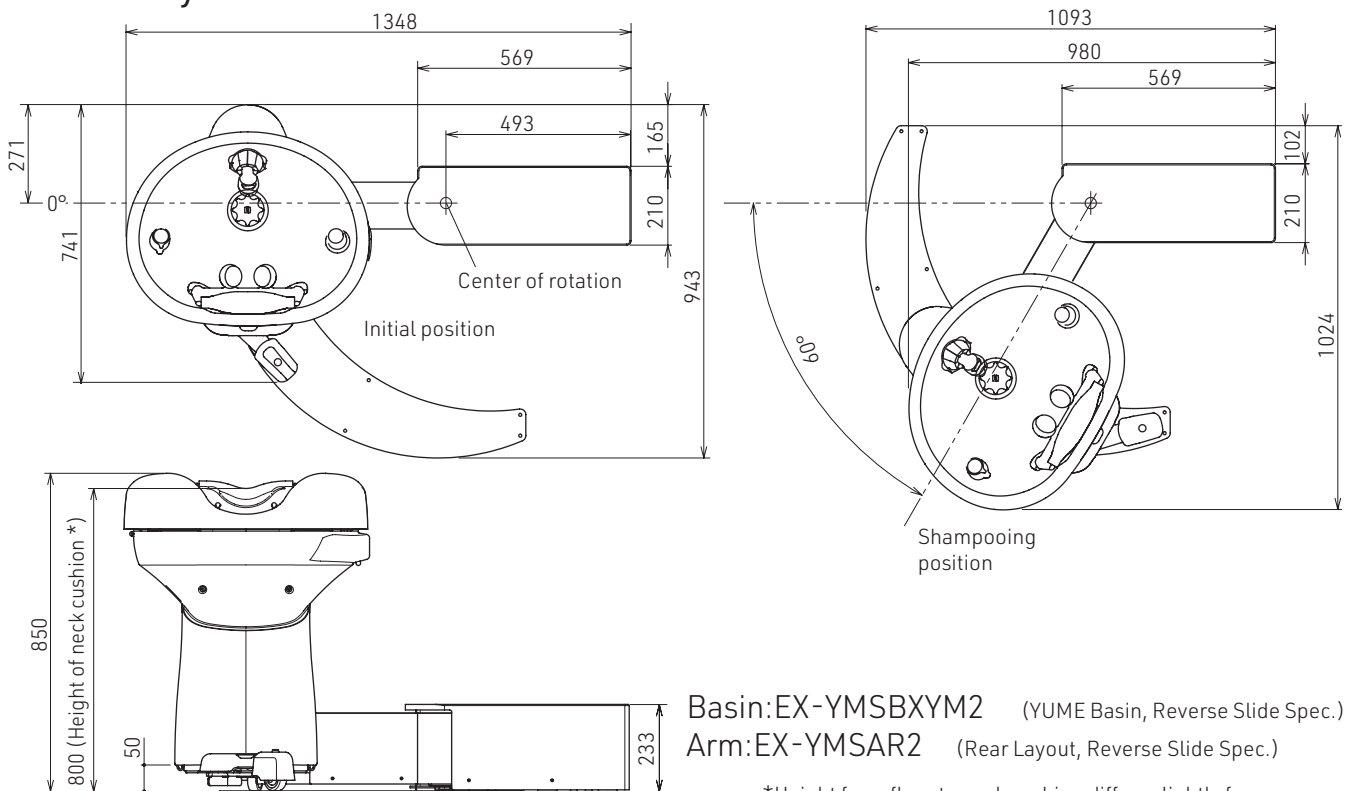

\*Height from floor to neck cushion differs slightly from product to product.

# Procedures for Daily Inspections

To ensure that this product can be used for a long period of time, conduct the inspections below. When repair is necessary, contact the nearest dealer or Takara Belmont directly.

## ■ Inspect the product every day

Inspection item	Inspection method	If the inspection results show defects
<input type="checkbox"/> Is the basin unit not wet with water?	<input type="checkbox"/> Check if the parts except inside of the basin is not wet.	<input type="checkbox"/> It may cause malfunction of the product, or stain may become hard to remove. Immediately wipe away the moisture adheres on the parts except inside of the basin.
<input type="checkbox"/> Is the mounting surface of the basin unit not wet with water?	<input type="checkbox"/> Visually check the mounting surface of the basin unit and check it is not wet with water.	<input type="checkbox"/> There is a possibility that water is leaking inside of the basin unit. Open the maintenance cover and check inside (Refer to pages 26 to 28.). If water is leaking from the pipes, immediately stop using the product, contact the nearest dealer or Takara Belmont directly.
<input type="checkbox"/> Have the neck cushion and head pillows not degraded?	<input type="checkbox"/> Check that there is no tearing, dirt or sinking on the surface of the neck cushion and head pillows.	<input type="checkbox"/> These may cause pain or transfer dirt to the client's neck and head. The neck cushion and head pillows are consumable supplies. Replace them as soon as possible.
<input type="checkbox"/> Is there no abnormal odor coming from the drain outlet?	<input type="checkbox"/> Check if there is no abnormal odor coming from the drain outlet.	<input type="checkbox"/> Remove any hair and other objects trapped in the hair catcher. (Refer to page 23.)
<input type="checkbox"/> Does the tap work properly?	<input type="checkbox"/> Turn the tap and check if warm water is discharged properly and there is no abnormal sounds. Then close the tap and check that warm water stops properly. *An abnormal gushing sound may be emitted as water flows. (Refer to page 14 to 15.)	<input type="checkbox"/> If abnormal sounds are heard, or the warm water does not turn off properly even when the tap is closed firmly, there may be a malfunction in the stop valves of the tap. Contact the nearest dealer or Takara Belmont directly.
<input type="checkbox"/> Is there no peeling found on the tap or thermostatic control knob?	<input type="checkbox"/> Visually check that if there is no scratches, cracks or peeling on the plated surface of the tap or thermostatic control knob. <input type="checkbox"/> Check if there is no abnormal conditions found when performing operation or maintenance.	<input type="checkbox"/> It may hurt your hands or fingers with the scratches, cracks or peeling on the surface of the plating, so immediately replace it. To replace the parts, contact the nearest dealer or Takara Belmont directly.
<input type="checkbox"/> Is water output from the shower head properly?	<input type="checkbox"/> Turn on the tap, and visually check that water is discharged normally from the shower head, water is not leaking from the foaming water outlet, or the hot water is not turbid.	<input type="checkbox"/> If water is leaking from the foaming water outlet or from the base of the shower head, the internal gasket may be worn out. If replacement is required, contact the nearest dealer or Takara Belmont directly. <input type="checkbox"/> If hot water does not come out normally, or it is turbid, there is a possibility that the filter of the check valve is contaminated. Clean the filter. (Refer to pages 26 to 28.) <input type="checkbox"/> When a few water line splashes out of the water flows, there is a possibility that lime scale or dirt may be contaminated in the shower head plate. Remove the shower head plate and clean it. (Refer to page 24.)
<input type="checkbox"/> Does the thermostatic control knob work properly?	<input type="checkbox"/> Turn the thermostatic control knob, check that the water temperature is adjusted properly and that there is no abnormal sound. *An abnormal gushing sound may be emitted as water flows. (Refer to page 14 to 15.)	<input type="checkbox"/> If the water temperature cannot be adjusted properly or if there is abnormal sounds, there may be a problem with the thermostat inside of the basin unit. Stop using the product immediately, and contact the nearest dealer or Takara Belmont directly.

Inspectionitem	Inspection method	If the inspection results show defects
<input type="checkbox"/> Can the basin be filled with water?	<input type="checkbox"/> Check that the drain cap can block the drain when turning it over, and water filling in the basin does not drain.	<input type="checkbox"/> When the water decreases quickly, there is a possibility that the drain cap gasket has deteriorated. The drain cap gasket is a consumable part. Immediately replace it. (Refer to page 26.)
<input type="checkbox"/> Is the mohair tape not deteriorated?	<input type="checkbox"/> Check that the mohair tape is not peeled, deteriorated or it does not become extremely dirty.	<input type="checkbox"/> Clean the mohair tape according to the supplied "Mohair tape" Manual. If the dual function shower head does not operate smoothly even after cleaning the mohair tape, contact the nearest dealer or Takara Belmont directly.
<input type="checkbox"/> There is a strange odor from shower head holder.	<input type="checkbox"/> Check if there is a strange odor from shower head holder.	<input type="checkbox"/> Replace the sponge, if the smell of sponge becomes a concern from outside the shower head holder. (Available at additional cost)

■ Items that must be inspected after closing for the day

Inspectionitem	Inspection method	If the inspection results show defects
<input type="checkbox"/> Is the drain not blocked ?	<input type="checkbox"/> Check that the drain is not blocked with the drain cap, towel or shampoo cloth.	<input type="checkbox"/> Remove the object that is blocking the drain. If the drain is blocked, water that is turned on accidentally or a slight trickle of water due to an increase in water pressure at night may cause water to spill from the basin, leading to water leakage.
<input type="checkbox"/> Has the tap been closed firmly ?	<input type="checkbox"/> Turn the tap firmly in a clock wise direction and check that the water turns off properly .	<input type="checkbox"/> Turn the tap firmly and turn the water off properly. If the water does not turn off completely, there may be a malfunction in the stop valves of the tap. Close the stop valves of the water / hot water supply pipes (Refer to pages 26 to 28.), immediately stop using the product and contact the nearest dealer or Takara Belmont directly.

■ Items that must be inspected once each week

Inspectionitem	Inspection method	If the inspection results show defects
<input type="checkbox"/> Is there any water leakage inside of the basin unit?	<input type="checkbox"/> Remove the maintenance cover of the basin unit and check that there is no water leakage from the internal pipes and water faucet. (Refer to pages 26 to 28.)	<input type="checkbox"/> If water is leaking from the pipes, the pipes and gasket may be worn, degraded or damaged. Close the stop valves in the water / hot water supply pipes (Refer to pages 26 to 28), immediately stop using the product, and contact the nearest dealer or Takara Belmont directly.
<input type="checkbox"/> Is there any water leakage from the drain hose?	<input type="checkbox"/> Check if there is no water leakage from the mounting part of basin unit and SWING Arm. (Refer to pages 26 to 28.)	<input type="checkbox"/> If water is leaking from the drain hose, the drain hose may be worn, degraded or damaged. Immediately stop using the product and contact the nearest dealer or Takara Belmont directly.
<input type="checkbox"/> Is there any lime scale or dirt blocking the shower head plate?	<input type="checkbox"/> Remove the shower head plate from the shower head and check that there is no lime scale or dirt on it. (Refer to pages 24.)	<input type="checkbox"/> Use an item such as a toothbrush to remove any dirt such as lime scale, and clean the shower head plate. Leaving the shower head plate unclean will lead to blockage, and water may not be output from the shower head properly.



**TAKARA BELMONT CORPORATION**  
1-1, 2-Chome, Higashi-shinsaibashi, Chuo-ku, Osaka, Japan  
TEL : +81-6-6213-5945      FAX : +81-6-6212-3680

Printed in Japan

1E04ZTB0