

# YUME OASIS

## Operating Instructions

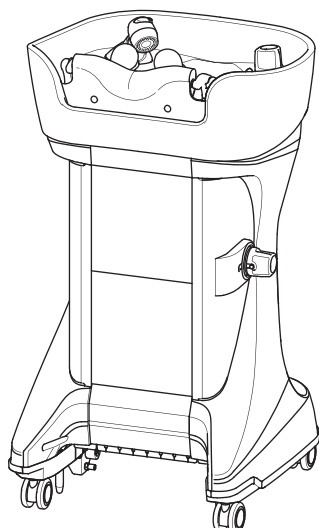

Upper unit  
Back Wash Basin (YUME Basin)  
Model No. EX-OAYMYM-\*

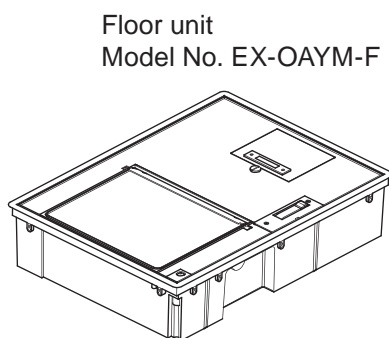

Floor unit  
Model No. EX-OAYM-F

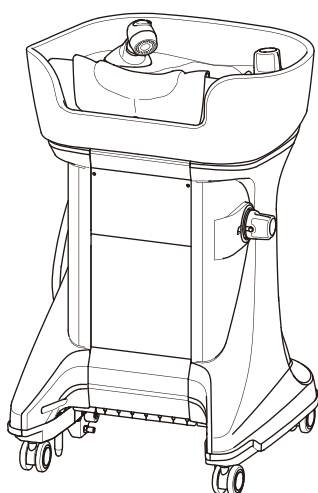

Upper unit  
Side Wash Basin  
Model No. : EX-OAYMSS-\*

The "\*" part of the individual Model No. shown above depends on the product color.

### Contents

General Safety Instructions	2
Safety Precautions	3
Precautions For Use	5
Precautions For Use Of Basin Products	7
Precautions For Use Of Resin-plated Parts	7
Position Of Warning Labels	7
Name Of Parts	8
Accessories	10
Before Using	10
Preparations	11
How To Use	13
What To Do After The close Of Business	24
Maintenance	25
Before Requesting Repairs	39
Consumables	40
Standard Duration Of Use	40
Disposing Of Product	40
After-sales Service	40
Emergency Response	41
Specifications	43
Daily Check Guide	44

Thank you for purchasing our TAKARA BELMONT product.  
Please read through this manual carefully before use for using this product correctly and safely.  
Using the product without reading the Operating Instructions may lead to an accident.  
In addition, this product is business-use shampoo equipment for barber and beauty salons that support shampoo and treatment service.  
Do NOT use for other than barber and beauty service.  
Only use this product for its intended purpose and do not use it for non-hairdressing work.  
After reading, keep this operation manual in a safe place for future reference.

# General Safety Instructions

## ■ Before Using

The "Safety Precautions", "Precautions For Use", "Precautions For Use Of Basin Products" or "Precautions For Use Of Resin-plated Parts" contained in this booklet should be thoroughly read and understood before use.

## ■ Precautions Listed Here

This instruction manual contains important information to avoid personal injuries, or property damages against you or your clients by using this product correctly.

These precautions are important for ensuring safety.

Adhere to these precautions at all times..







TAKARA BELMONT is not responsible for any damage or risk to the person using this product or those around them due to accidents if this product is used without adhering to the "Safety Precautions", "Precautions For Use", "Precautions For Use Of Basin Products" or "Precautions For Use Of Resin-plated Parts".

In this case, the person failing to adhere to the "Safety Precautions", "Precautions For Use", "Precautions For Use Of Basin Products" or "Precautions For Use Of Resin-plated Parts" will be responsible for any damage or risk incurred.

Detailed descriptions of symbols are provided below.

Read and understand these symbols thoroughly before reading this Operating Instructions.

## ■ Symbols

 <b>WARNING</b>	This mark warns the user that "improper use may cause death or severe personal injuries".
 <b>CAUTION</b>	If this symbol is ignored and the product is used, "there is the risk of death or serious injury to the user".
<b>Note</b>	Description of "ideal points to adhere to for safety".
 Common danger, warning and caution notifications	 Indicates what a user is forced or instructed to do.
 This mark indicates that the user must be ALERT against a possible danger.	 Indicates the notice of high-temperature condition. <b>CAUTION HOT</b>
 Do NOT Disassemble Indicates that disassembly, repair, and modification are prohibited.	

# Safety Precautions

## WARNING



### Do NOT get on or hang from the basin.

Do NOT attempt to disassemble or repair the equipment on your own.  
Damage to the product or deformation may be caused. Failure to follow this instruction may cause the product tipped over, leading to injury.

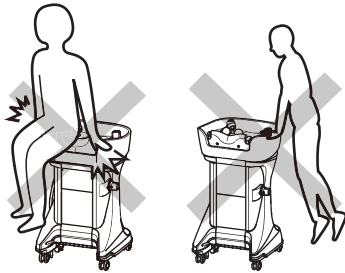

### Do NOT attempt to repair the unit by yourself.

Do NOT attempt to disassemble or repair the equipment on your own. Failure to follow this instruction may cause the water leak or abnormal operation, leading to injury.



### Adjust the temperature of warm water while checking it by hand.

When adjusting the hot water temperature, reduce the volume of hot water, point the shower head away from the customer and check the temperature by your hand. Take care when doing so, as hot water may come out of the shower head.



### Return the temperature control handle to an appropriate position after using hot water.

After using hot water, return the temperature control handle to the safety lock position. Continuing to use the hot water in the hot position may cause burns.



### Do NOT use hot water (boiling water) of 60 °C or higher.

Using hot water at 60°C or higher may deform or damage the ceramic basin, the shower head, or the faucet handle.



### During business hours, do NOT leave the top panel swing or the maintenance lid.

It may cause someone to catch his/her foot in the floor unit or trip over and be injured. In addition, it causes damage to the product, piping, etc.



### When working between a chair and the basin, do NOT lean against the basin.

If you provide any service for the customer leaning against the basin, the product may fall down and cause damage to the product or personal injury. In addition, color agent on the neck cushion or the basin may soil clothing.



### Do NOT put your fingers in any movable parts.

Do NOT put your fingers in any movable parts. If you are caught, it causes injury.

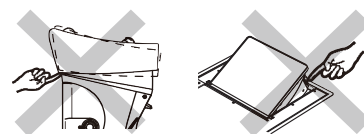

### If you are not used to, do NOT use.

Failure to follow this may lead to improper operation and may cause burns or injuries.



### When reclining or returning the backrest, support the customer's head by hand.

When reclining or returning the backrest, support the customer's head by hand. Failure to follow this instruction may cause the customer to bump his/her head against the basin and become injured.



### Take great care when operating the chair.

For a chair with the auto set function, take great care not to get your body caught between the chair and the basin when operating the reclining mechanism of the chair.



### When the customer is lying in the chair, do NOT separate the upper unit.

Customer may be injured due to a significant load.



### When guiding a customer to a seat, ask him/her to watch his/her steps.

















If the customer is not careful, he/her may trip over the assist buttons or the release levers and be injured. In addition, do NOT guide a customer to a seat with the top panel swing.

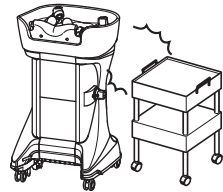

### Do Not leave the rotary knob of maintenance lid jumping out.

Failure to follow this instruction may cause the customer to trip over the rotary knob and become injured.

 CAUTION

<p> <b>Do NOT spray the water with the shower head placed in the shower head holder.</b></p> <p>Failure to follow this instruction may cause water to spill out of the basin, covering the customer with water. When supplying water with the shower head placed in the shower head holder, check the surroundings and then slowly turn the faucet handle.</p>	<p> <b>Do NOT leave the shower head in the filled water basin.</b></p> <p>Failure to follow this instruction can result in a back flow of water in the basin when the pressure in the water piping decreases as the water supply is suspended for execution of work.</p>
<p> <b>Do NOT apply excessive weight on the basin or the cover.</b></p> <p>Please do not apply excessive weight or ride on the basin or the cover. This may cause deformation or breakage of the product.</p>	<p> <b>Do NOT use for other than the barber and beauty service.</b></p> <p>This product is for business use by the barber and beauty service. Do NOT use for other than the barber and beauty service. Also, do NOT wash any animals, such as pets.</p>
<p> <b>Never use the product with the customer lying face down.</b></p> <p>The customer may become injured or the water may spill out of the basin.</p>	<p> <b>Always use the neck cushion.</b></p> <p>Without a neck cushion, the customer's neck is strained and the customer may become injured. Always use a neck cushion.</p>
<p> <b>Do NOT use with the plating peeled off.</b></p> <p>If the plating of the faucet metal fittings (faucet handle, temperature control handle) is peeled off. If use them with the plating peeled off may cause injuries.</p>	<p> <b>Before supplying water, check the temperature set position of the temperature control handle.</b></p> <p>When supplying water, check the temperature set position of the temperature control handle. Failure to follow this instruction may cause hot water to come out and cause burns.</p>
<p> <b>Stand the upper unit in a secure place when not in use.</b></p> <p>Standing it in an unstable place may lead to falling down or turning over of the equipment.</p>	<p> <b>Do NOT apply excessive weight on the floor unit.</b></p> <p>Please do not jump on or place a heavy object on the floor unit. This may cause damage on the unit or cause the unit to sink to the floor.</p>
<p> <b>Do NOT make an impact on the product.</b></p> <p>Do NOT make an impact on the product. Failure to follow this instruction may damage the product.</p> 	<p> <b>Do NOT use the product with the maintenance cover open.</b></p> <p>This instruction may cause burns due to hot pipe.</p>
<p> <b>Be careful about the level difference between the assist button and the release lever.</b></p> <p>There is a level difference of approx. 3 to 6 mm between the assist button / release lever and the floor. Take great care not to trip over while walking. You may trip over and fall down and become injured.</p>	<p> <b>Do NOT drink the hot water.</b></p> <p>This product is for the purpose of shampooing. Do not drink the hot water. The water quality may cause diarrhea or stomach pain.</p>
<p> <b>When moving the upper unit, check the surroundings.</b></p> <p>Provide space enough to avoid a collision with a person or object, and slowly move it. In addition, be sure to put your hands on the basin when moving it.</p>	<p> <b>Do NOT use the product with the cover damaged.</b></p> <p>If you keep using the product without replacement, it may cause a malfunction or accident.</p> <p> <b>Do NOT use the product where it is expected to be frozen.</b></p> <p>Failure to take this precaution may result in breakage of parts, thus resulting in water leaks. If it is expected to be frozen, keep it at a temperature of 0 degrees or more by heating.</p>



# Precautions For Use

## CAUTION

### Do NOT use a peppermint oil or aroma oil.

Do NOT use any peppermint oil or aroma oil that contains menthol.  
The oils may cause damage to resin parts, such as the shower head, shower head holder, shower hose, faucet handle, temperature control handle, neck cushion, hair trap, and trap cover.

### Do NOT wipe with chemical agents nor apply heat.

At the time of maintenance, do NOT wipe with chemical agents nor apply heat in such a way as to dry with a dryer. Failure to follow this instruction may cause deterioration/discoloration.  
In the event that chemical agents adhere to the covers, immediately wipe them off.

### If not in use, do NOT block the drain port. (With the floor unit connected)

After the completion of work, do NOT block the drain port with the trap cap, a towel, or a shampoo cloth.  
If warm water comes out by mistake or a small amount of warm water comes out due to an increase in water pressure late at night, water may spill out of the basin, resulting in a water leak accident.

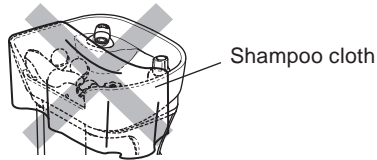

Shampoo cloth

### Remove chemical immediately after it attached.

If chemical such as hair dye attached to the equipment, wipe it out immediately. This may cause discoloration or deterioration. Do Not use a chemical agent or hot water. Failure to follow this instruction may cause deterioration/discoloration.  
In the event that chemical agents adhere to the covers, immediately wipe them off.

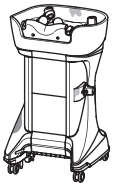

### Avoid the heat from direct sunshine and stoves.

Avoid the heat from direct sunlight and stoves. Failure to follow this instruction may causes discoloration and deterioration of resin covers.

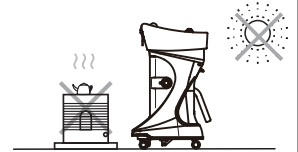

### Do Not water to the shower head holder.

Do Not water to the shower head holder. It may cause water leaks.



### Do NOT use a cleaning agent of strong acid / strong alkali.

When cleaning drainpipes etc., do NOT use a cleaning agent that contains caustic soda (NaOH) or caustic potash (KOH) as its principal component. Never pour thinners, alcohol, nail polish remover, gasoline or kerosene into the drain. Failure to follow this instruction may damage the drainpipes.

### Do NOT use outdoors.

This product is intended for indoor use only. Do NOT place outdoors or in vehicles. Be sure to use inside barber and beauty salons. Failure to follow this instruction may cause a malfunction in or damage to the equipment.

### Do NOT use abrasives.

Do NOT apply abrasives to the basin, shower head, stop valve, or covers. In addition, the use of rigid cleaning tools, such as sponges containing abrasives and wire wools, may cause scratches.

### Take care not to cause an interference with the chair (especially the leg rest and the step).

If the chair is turned with the leg rest stretched or if it is elevated with the rest facing to this product, it comes into contact with this product and the customer may become injured or this product may be damaged. Before turning/elevating the chair, check that there is no interference with this product.

### Do NOT touch hot-water supply pipes.

Do NOT touch hot-water supply pipes. As they are high in temperature, you may get burned.

















### Clean the hair trap regularly.

Clean the hair trap as regularly as possible. If it is used without cleaning, the drain port is clogged with a buildup of hair etc., which causes water to overflow, resulting in unsanitary conditions. Try to clean it every time you shampoo customer's hair. After the completion of work, do NOT leave the upper and floor units connected. In the event of water leakage from cold/hot water supply couplers, water leak accidents may occur.

### Do NOT pour water on the outside of the basin and the cover of the main unit.

Failure to follow this instruction may cause water to enter the upper unit, resulting in formation of rust in the equipment body.

 CAUTION

<p> <b>Do NOT bump a thing on the product.</b></p> <p>Do not bump the product with a hard object. This may cause deformation or breakage of the product.</p>	<p> <b>If the floor is wet, be sure to wipe it out.</b></p> <p>If the floor is wet after the completion of a shampoo, immediately wipe it out. Failure to follow this instruction may degrade the floor or you may slip and fall.</p>
<p> <b>After the completion of work, be sure to wipe off moisture on the areas other than the basin.</b></p> <p>If the product is left with moisture, it may cause a malfunction of the equipment or make it impossible to remove soil.</p>	<p> <b>Do NOT provide front shampoo services.</b></p> <p>Water may spill out of the basin.</p>
<p> <b>Adjust the hot water supply temperature into the equipment to 80°C or less.</b></p> <p>Failure to follow this instruction may cause a malfunction in or damage to the stop valve, check valve, flexible hose, thermostat faucet, etc.</p>	<p> <b>Take care in handling the neck cushion.</b></p> <p>Do NOT bring cutters and sharp objects, such as scissors, (including grown nails) into contact with or press them against the neck cushion.</p>
<p> <b>Do NOT move the upper unit with water or heavy objects in the basin.</b></p> <p>Failure to follow this instruction may cause the water to spill out of the basin, making the floor, furniture, and clothing dirty. In addition, the upper unit may fall down and be damaged.</p>	<p> <b>Failure to follow this scratches or damages skin.</b></p> <p>When using the neck device in a fixed state, be sure to lock the neck-holding pin. When using the equipment without locking the neck-holding pin and if the locked neck device is released during the service, the customer may hit his/her head against it and become injured. It is required only Back Wash Basin (YUME Basin).</p>
<p> <b>Do NOT drop heavy or sharp objects on the basin.</b></p> <p>Do NOT drop or place the heavy or sharp objects on the basin. Failure to follow this instruction may cause damage such as scratches or cracks to the basin.</p>	<p> <b>Fully close the faucet handle.</b></p> <p>After the completion of use or work, fully turn the faucet handle clockwise to the end to ensure that the water stops. Failure to completely stop the water may cause water leak accidents.</p>
<p> <b>Do NOT wash sharp objects such as scissors.</b></p> <p>Failure to follow this instruction may scratch or damage the pottery and the neck cushion.</p>	<p> <b>Do Not provide shampoo services sitting on a stool.</b></p> <p>This product is shampoo equipment intended for offering services in the standing position. If the shampoo service is provided in the sitting position, the shampoo hose may come into contact with the feet, making the clothing wet.</p>
<p> <b>Do NOT put or drop any objects in the water basin.</b></p> <p>If any objects get caught between the top panel swing and the water basin, the top panel swing may not be able to close or the equipment may be damaged.</p>	<p> <b>Do NOT bump any objects against the handles of the resin-plated parts.</b></p> <p>Do NOT bump any hard objects against the temperature control handle or the faucet handle of the resin-plated parts. Failure to follow this instruction may cause flaws or cracks on the plated surfaces and separation of plating, resulting in injury.</p>
<p> <b>When working between a chair and the basin, take care not to damage the product with your belongings.</b></p> <p>Providing treatment services while carrying metal objects, such as scissors, may damage the basin and the chair or cause injury.</p>	<p> <b>When storing the upper unit, take care so that it does not hit against walls.</b></p> <p>When storing the upper unit, take care so that it does not hit against walls or another one. Failure to follow this instruction may damage the equipment and walls.</p>

# Precautions For Use Of Basin Products

This product uses pottery for the basin.

Note in advance that bends and deformations cannot be avoided depending on the product in molding of the neck position and the pottery, and there are slight variations in height, shape, and weight.

In addition, because of the nature of pottery, pouring hot water in a pottery part may result in a sudden expansion of that part, causing cracks in the surface.

Do NOT pour hot water in the pottery. Failure to follow this instruction may damage to the pottery, causing injury, or cause water to enter the upper unit due to a water leak, resulting in formation of rust.

# Precautions For Use Of Resin-plated Parts

- The faucet handle and the temperature control handle of this product are resin-plated.
  - The plating is a thin and hard metal film, which may cause cracks and separation in the plated surfaces due to corrosion and aged deterioration.
  - An impact of falling objects may cause flaws and cracks in the plated surfaces.
  - If a hard object hits, flaws, and cracks may be caused on the plated surface.
  - Starting from a flaw or a crack on the plated surface, separation of the plating may occur.



Before use, check that there are no flaws, cracks, nor separation of plating on the plated surface of the faucet handle and the temperature control handle. If you keep using the equipment, you may become injured.

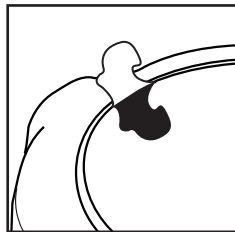

An example of separation on the plated surface

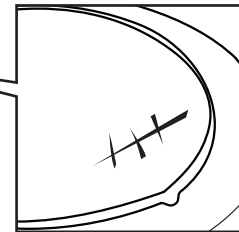
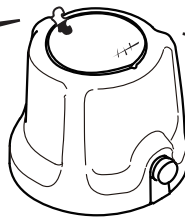

An example of flaws on the plated surface

# Position Of Warning Labels

□ Upper unit

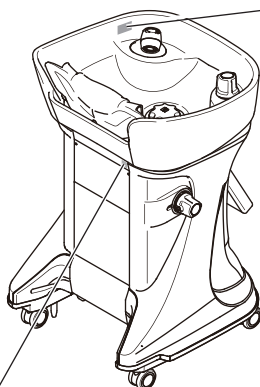

**CAUTION**

Drain Outlet      Drain Cap

The drain cap must be detached from the drain outlet when the product is not in use.

only for Back Wash Basin (YUME Basin)

□ Floor unit

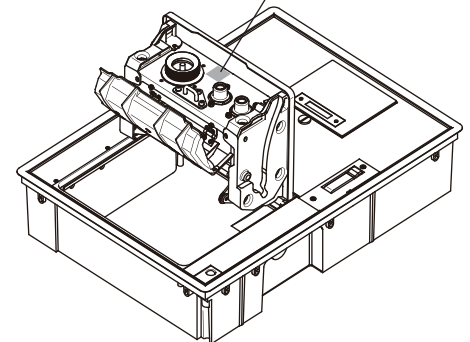

**WARNING**

Risk of Pinching!

**WARNING**

Risk of Pinching!

**WARNING**

Risk of Pinching!

<b>CAUTION</b>	<b>CAUTION</b>	<b>CAUTION</b>
Do not use hot water of 60°C and higher. Using hot water at 60°C and higher may deform or damage the ceramic bowl, the shower head or the faucet handle.	If chemical such as hair dye attached to the equipment, wipe it out immediately, or it may cause discoloration or deterioration.	Do not use chemical detergent mainly containing caustic soda (NaOH) & caustic potash (KOH) for cleaning drain pipes, etc. This may cause damage on the drain hose, etc.
For other cautions, please read the operating instruction carefully before use.		

# Name Of Each Parts

## ■ Upper Unit

### <Back Wash Basin (YUME Basin) >

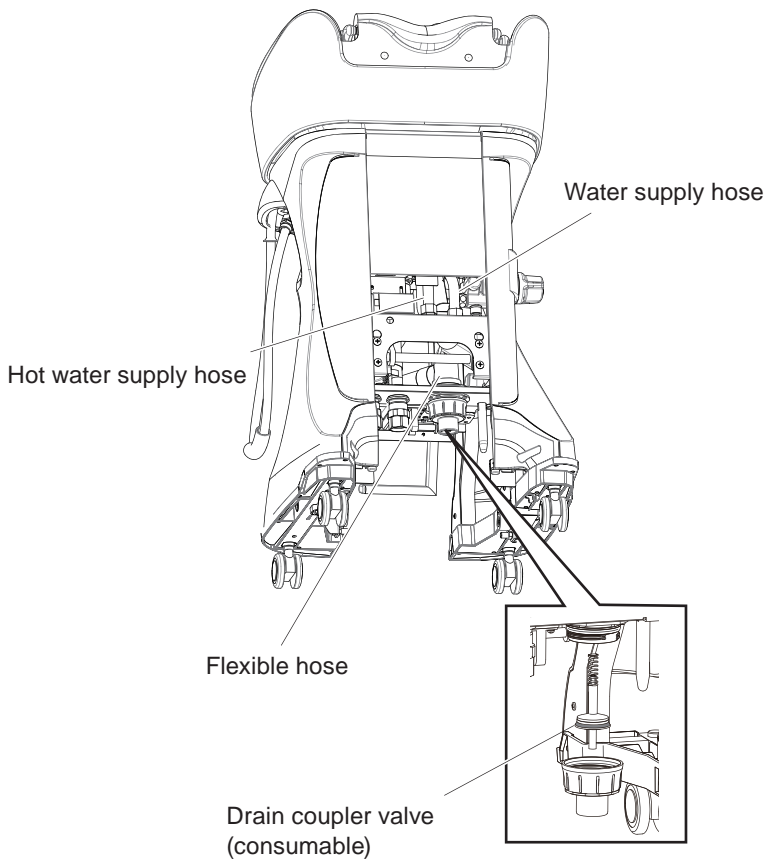
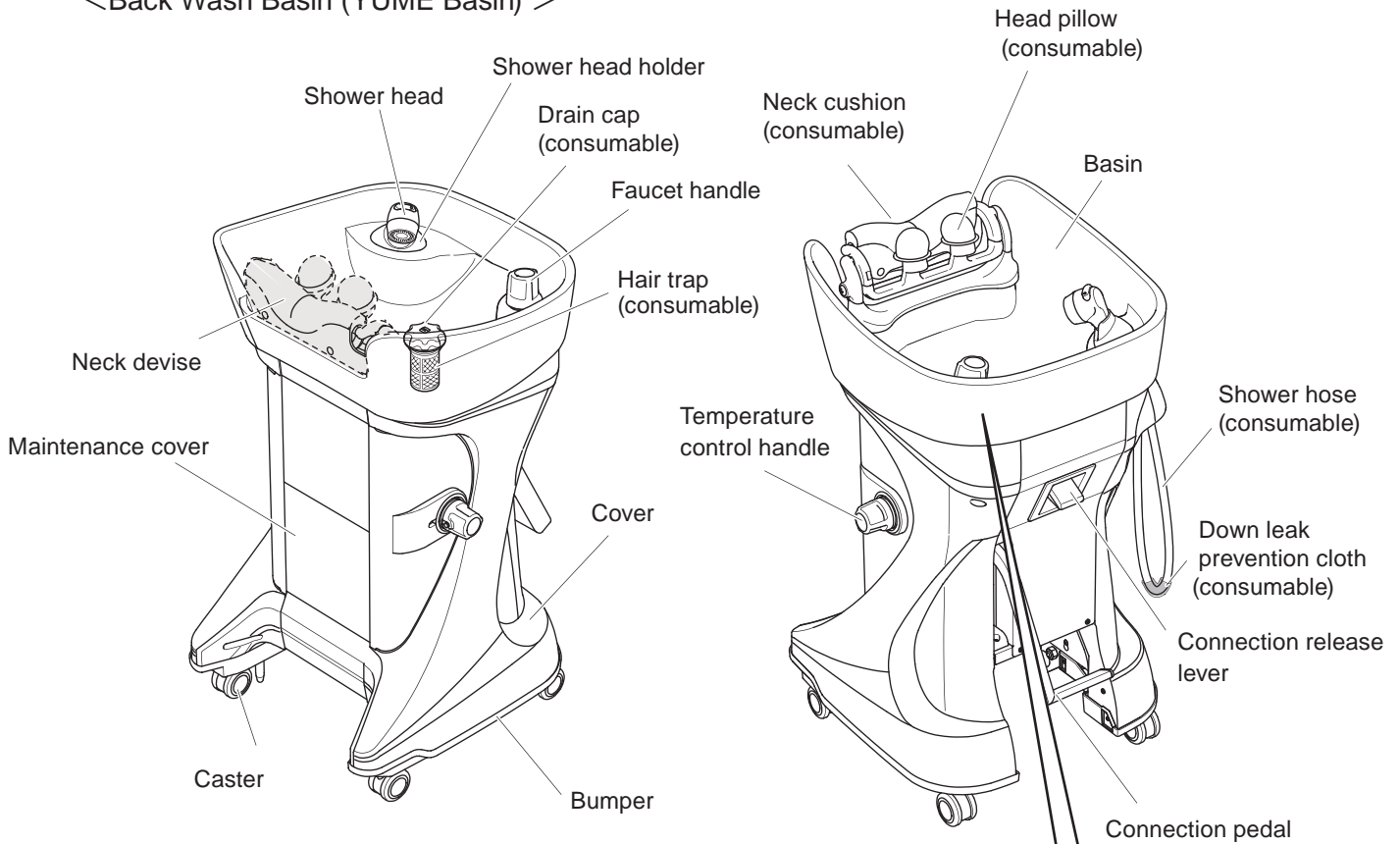

### <Side Wash Basin>

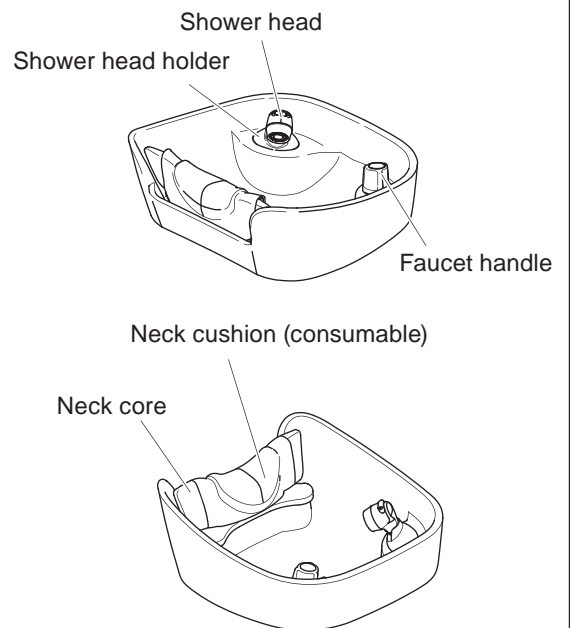

## ■ Floor Unit

<With the lid on>

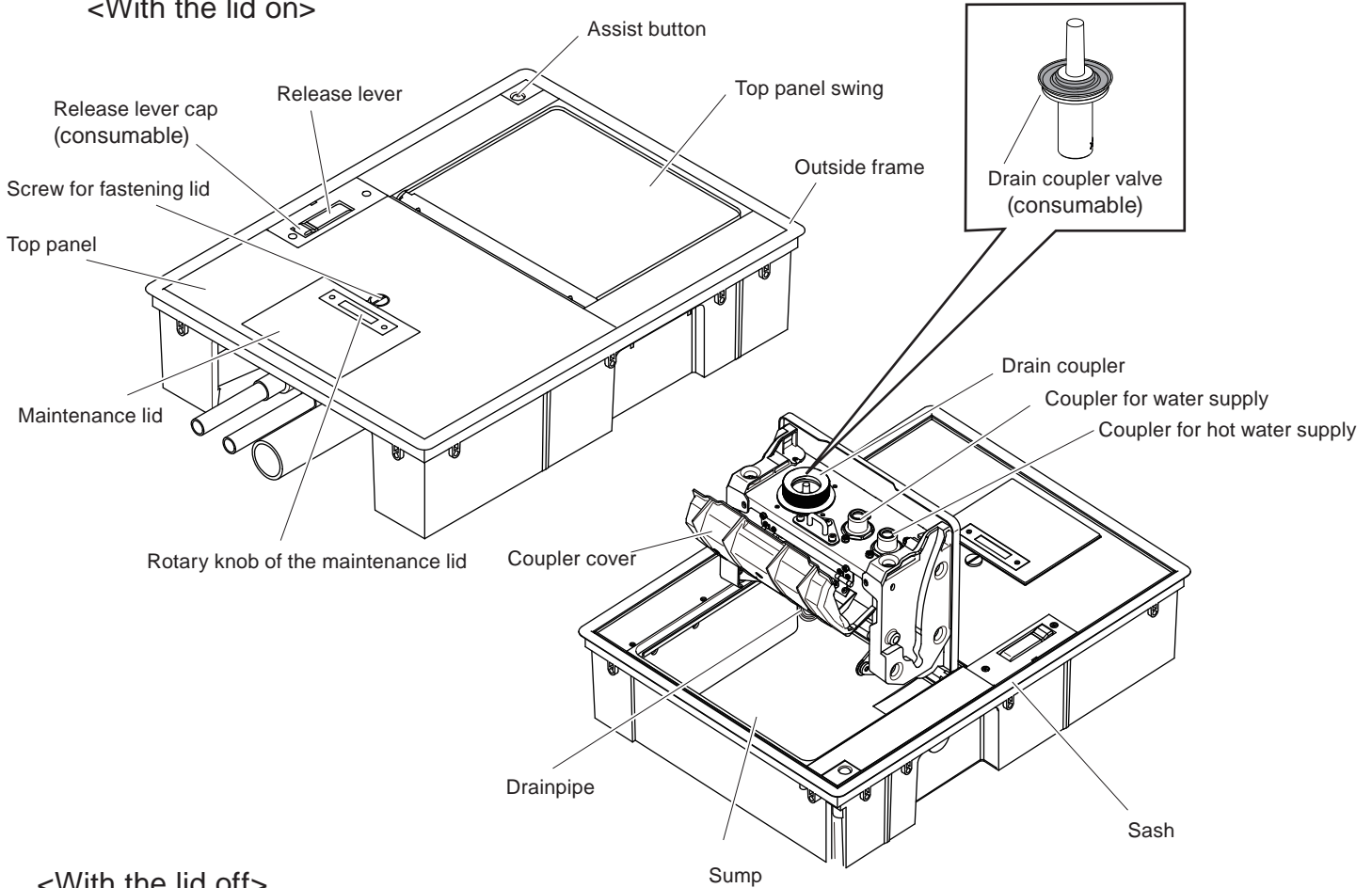

<With the lid off>

※ Layout of the supply/draining piping is subject to the condition of installation.  
Actual layout may be different from the illustration as shown below.

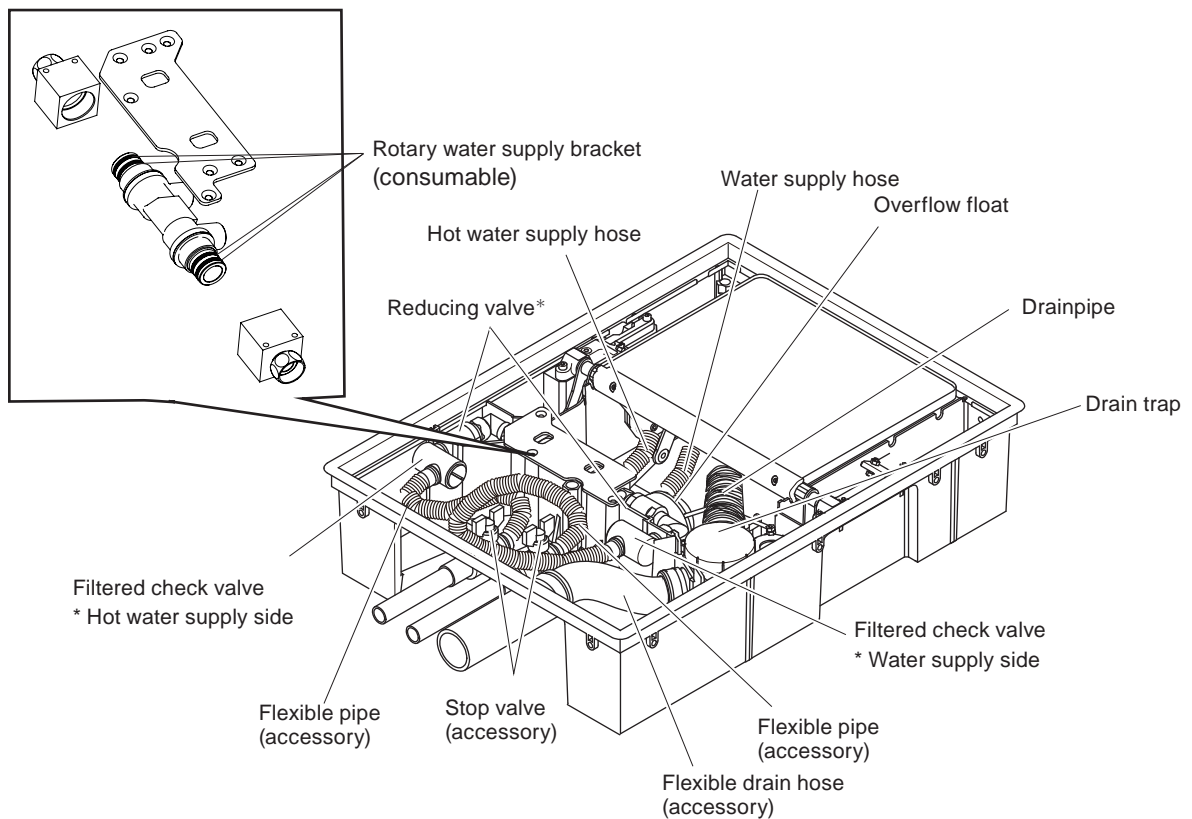

\* All the floor units come equipped with pressure-reducing valves as standard [0.18 MPa (1.8 kg f/cm<sup>2</sup>)].



# Accessories

## ■ Upper Unit

Common in Back Wash Basin (YUME Basin) and Side Wash Basin

- Drain cap (consumable)



- Hair trap (consumable)



- Grease (consumable)  
\* Used in maintenance (See page 34.)



- Surface water travel prevention cloth (consumable)

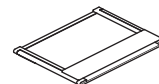

- Drain trap tool

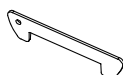

- Operation manual (this document)
- YUME SPA Technical Manual(except for China)
- Maintenance manual

### Only For Back Wash Basin (YUME Basin)

- Neck cushion (consumable)

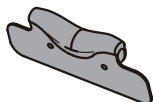

- Head pillow...2 (spare 1) (consumable)



- Tickle stopper rubber...2 (spare 1) (consumable)

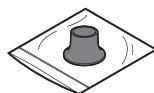

- Tickle Stopper Rubber Manual
- Dry cell (AA): 2 (consumable)

### Only For Side Wash Basin

- Neck cushion (consumable)

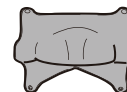

- Neck core



## ■ Floor Unit

- Installation Instructions
- Release lever cap (consumable)

# Before Using

- The Back Wash Basin (YUME Basin) is shampoo equipment intended for rear shampoo<sup>\*1</sup> and treatment services.
- The side shampoo basin is shampoo equipment intended for side shampoo<sup>\*2</sup> service.
- The back approach<sup>\*3</sup> with this product assumes providing service in the standing position. (It is not possible to provide services, such as a shampoo, in the sitting position.)
- With this product, it is not possible to provide a front shampoo<sup>\*4</sup> service.
- Check that the accessories are properly attached to the product.
- Note that in advance there are slight variations in clearance between the covers and between the basins and the covers depending on the product.
- The clearance between the basins and the covers are larger than that between the covers. This is because the basins are of pottery, causing no quality issues.

\*1 Rear shampoo : This means that staff provide shampoo services from behind the basin (in the rear position).

\*2 Side shampoo : This means that staff provide shampoo services standing next to the basin (in the side position)

\*3 Back approach : This means that staff provide services, such as treatment services, from behind the basin.

\*4 Front shampoo : This means that staff provide a shampoo service with the customer stooped and face down.



# Preparations

## <Back Wash Basin (YUME Basin) >

### ■ Attach Neck Cushion

1. Set the neck cushion to the mounting bracket in the direction as shown in the image.  
Please pay attention to the direction of back and forth.  
Attach the left hooks of the neck cushion to the neck-holding pin of the mounting bracket.

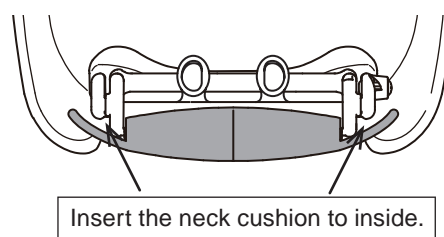
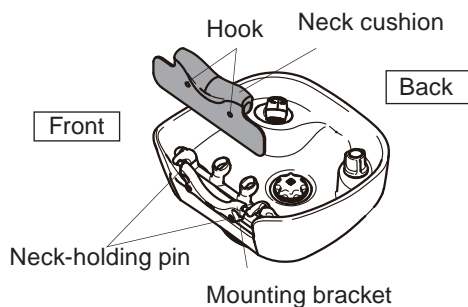

2. Attach the front hooks of the neck cushion to the neck-holding pin in the inside of the basin.  
Check that both front and back hooks are attached.
3. Adjust the shape of the neck cushion to suit the mounting bracket,  
and attach the basin side hooks of the neck cushion to the neck-holding pin.  
Check that both front and back hooks are attached.

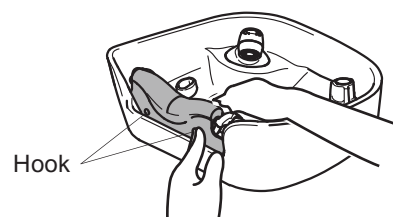

The fastening pins are detachable.  
Take care not to lose the fastening pins.



#### CAUTION

- When remove the neck cushion, detach the four hooks from the neck-holding pins, raise the neck cushion, and then remove it.  
If an excessive force is applied to forcibly detach the hooks, the part can be damaged.
- Surely insert the neck cushion into the inside of the basin.  
If the neck cushion is not tightly inserted, water water may splash from the front of the basin.
- Applying excessive force to remove the neck cushion may damage the parts.

### ■ Attach Head Pillow

Insert the head pillow in the direction as shown in the image.

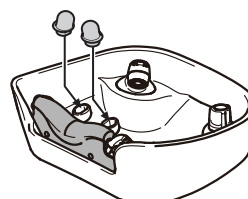
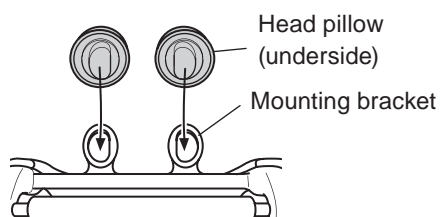

#### Note

Neck cushion and head pillow are consumable supplies.  
Replace them if they are extremely dirty or the surface has deteriorated.

## <Side Wash Basin>

### ■ Attach Neck Cushion

1. Align the neck cushion to the center of neck core as the below.  
Please pay attention to the direction of back and forth.

2. Align the height of the neck core and neck cushion ends (both ends).  
Fix the hook light pulling the neck cushion on the under surface of neck core.

<Top View>

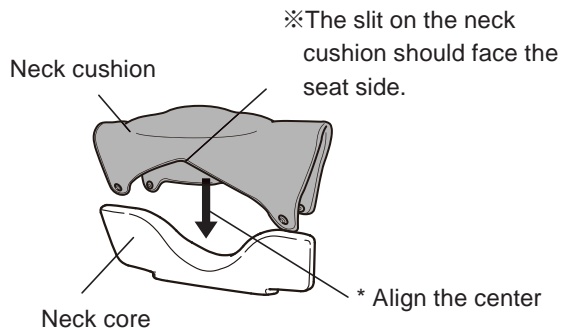
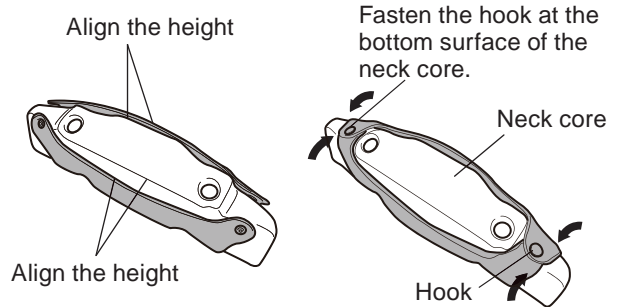
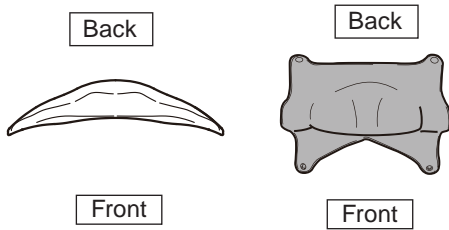

3. Fix the neck core to the neck base, and then attach it.  
Take note of the direction to fix the neck core.

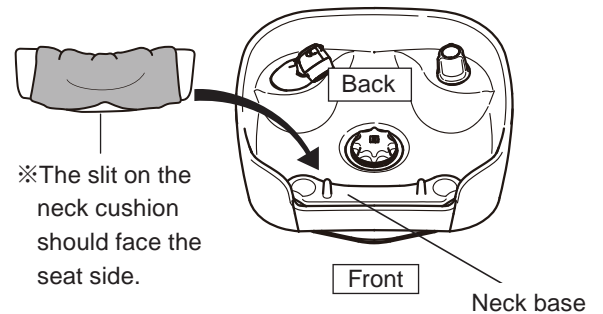

Do not force the neck cushion if it does not fit smoothly.  
Instead, check the following points.  
Forcing the neck core on may cause damage to the neck base or injury to customers.

- Check the neck core insert the direction.
- If the neck cushion is loose, check the direction of the neck cushion toward the neck core.
- If the neck core dowel hole is clogged with dirt, clean and remove the dirt before use.

If neither of the above are appropriate and the cause still remains unknown, contact your closest dealer.



When removing the neck cushion, remove the neck cushion from the neck core, and then remove the two hooks.

Applying excessive force to remove the neck cushion may damage the parts.

#### Note

The neck cushion is a consumable supply.  
Replace them if they are extremely dirty or the surface has deteriorated, replace it (on a chargeable basis).

# How To Use

## ■ How To Connect Upper Unit And Floor Unit

### 1 Clean out the top of the floor unit removing hair etc. fell on it.

 **CAUTION** Before connecting the upper unit, always clean out the top of the floor unit removing hair fell on it using a broom etc.  
If hair is left as it is, it is prone to build up inside the floor unit.

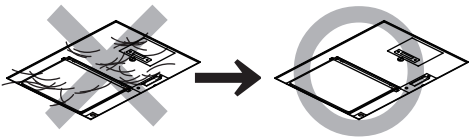

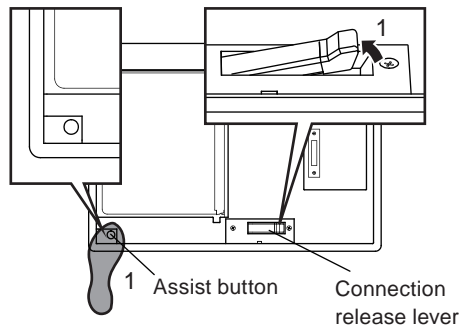

### 2 Open the top panel swing.

1. Step on the assist button to lift the release lever.

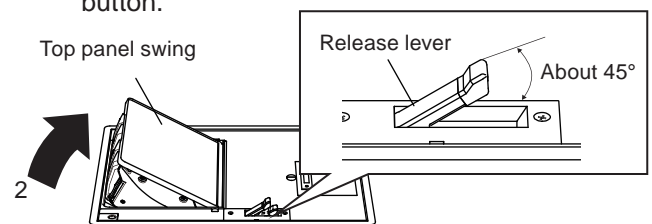

2. Lift up up to the angle picture indicated with one foot with the other foot stepped on Assist button.



 **CAUTION**

The maximum angle of release lever is about 45°. Kicking up and applying excessive force may damage the product and be injured.

### 3 Fit the upper unit to the top panel swing.

Hold the basin and slowly move the upper unit forward.  
Fit it so that the top panel swing of the floor unit is inserted to the opening of the upper unit.  
Keep moving it forward slowly until the upper unit is locked.

\* You feel a light click when it is locked.

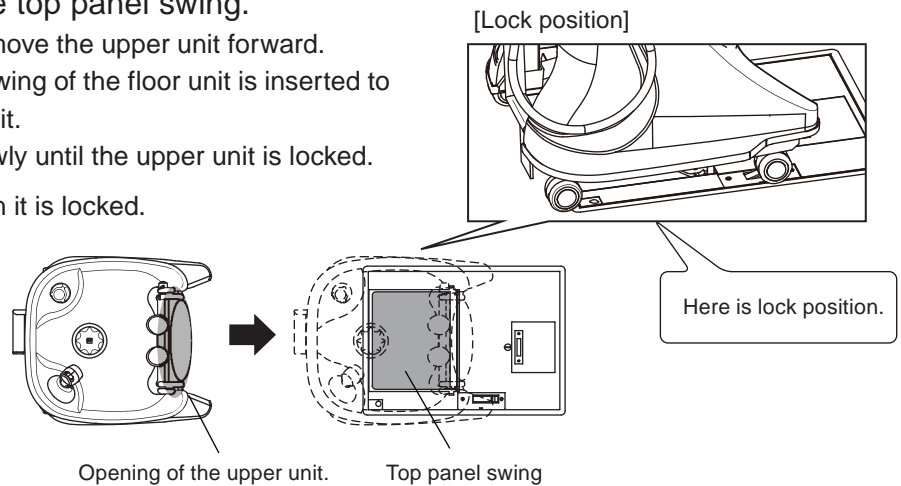

 **!**

- When the upper unit is transferred, securely hold the basin with both hands and move it slowly. Pay attention to any obstacles on the floor.
- Check that the upper unit is locked to the floor unit. Stepping on the connection pedal when it is not locked may cause damage to equipment.
  - ※ If it does not return backward even after the upper unit is released, it is locked.
- When the upper unit is fit to the top panel swing and it comes near the lock position, support the basin with your hand and move it slowly. If you rush to fit it to the top panel swing or lock it, damage to the devices or injury may be caused.

 **CAUTION**

When the upper unit is transferred, check the surroundings of the upper unit. Collision to a person or an object may result in injury or damage.

When inserting the upper unit diagonally to the floor unit, it may stop before the lock position. In such a case, do NOT force the insertion, but after returning the upper unit backward once, insert it again parallel to the floor unit. Forcing to insert it may cause damage to the product.

  
CAUTION

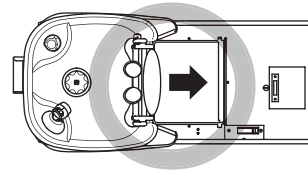
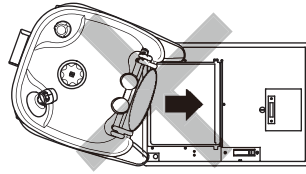

#### 4 Connect the piping

Hold both sides of the basin so that it does not move, and then slowly step on the connection pedal with your foot until you hear it click to connect the pipe.

- \* Depress the connecting pedal straight down.
- \* If it is not firmly secured, the connecting pedal will come up. Depress the pedal again.

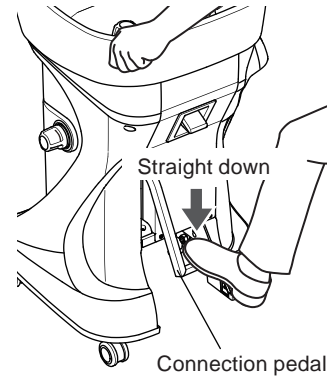

<If connection is difficult>

Repeat depressing two or three times. If it is still difficult, pull back the upper unit, and then retry the Step 3 and 4.

  
CAUTION

- Check that the flexible hose is surely locked.
- Do not stand on the connection pedal or apply excessive force. Damage to the product or deformation may be caused.
- Do NOT step on the connection pedal if the upper unit is unlocked (the upper unit's position is moved back). Failure to follow this causes breakage or deformation of the product.

The pipe has been successfully connected and a shampoo can be offered.

### ■ How To Position And Provide A Shampoo

#### 1 Set the client

Supporting the customer's head by hand, recline the backrest of the chair and gently put the customer's head on the neck cushion.

※ For instructions on reclining the backrest of the chair, see the Operating Instructions for each chair.

  
CAUTION

- When reclining the backrest, support the customer's head by hand. Failure to follow this instruction may cause the customer to bump his/her head against the basin and become injured.
- For a chair with an automatic set function, take care not to get your body etc. caught between the chair and the basin when reclining it.

Note

The guideline of the clearance between the backrest of the chair and the basin is 15 mm.

※ Reclined at the highest position of the chair.

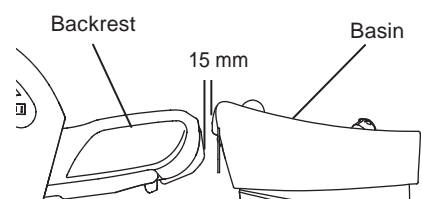

Check whether the face angle is as shown in the figure below with individual shampoo units and by the posture.

If not, ask the customer to move back and forth to make fine adjustments.

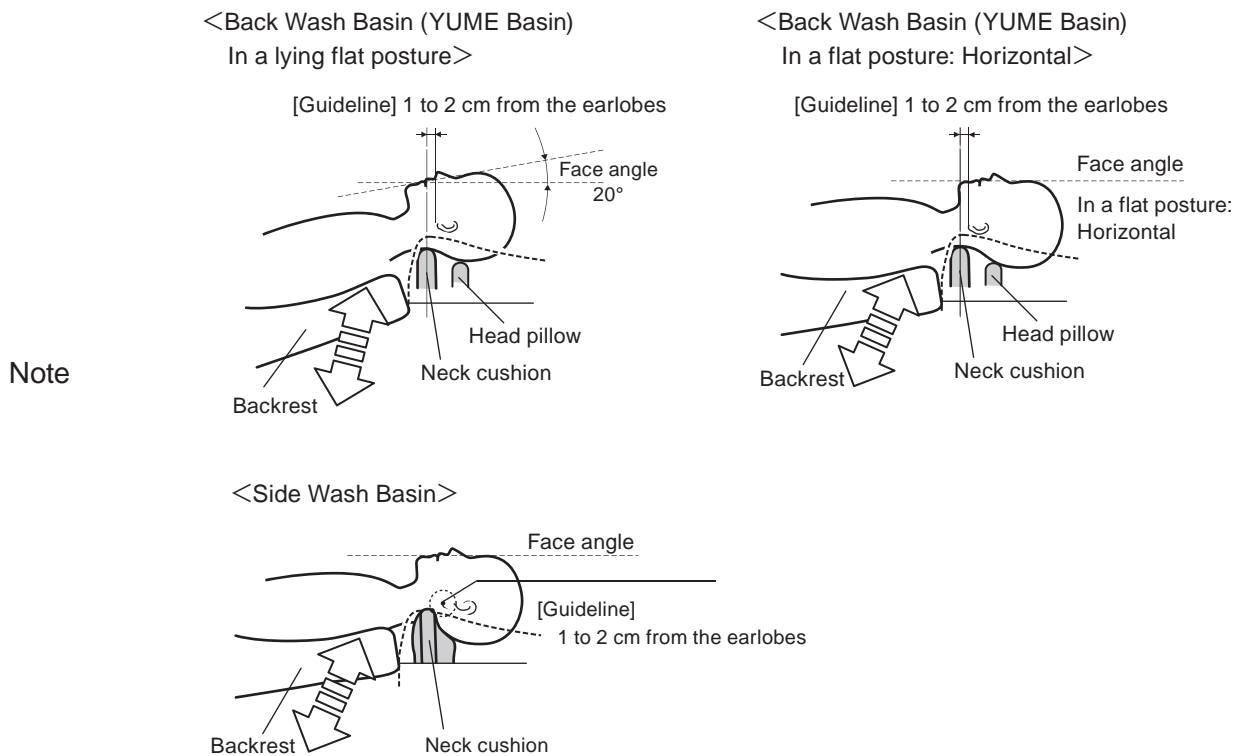

## 2 Check that the chair and the basin are aligned and in line.

If necessary, release the rotary lock of the chair and make fine adjustments so that the chair and the basin are aligned and in line.

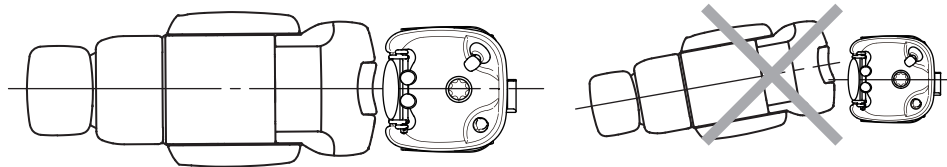

 **WARNING** With the customer lying, release the rotary lock of the chair and, if you would like to make fine adjustments to the chair, support the customer's head by hand.

## 3 After making the fine adjustments, lock the rotation of the chair again.

 **WARNING** After making the fine adjustments to the chair, always lock the rotation of the chair and then provide a shampoo service. If the rotation is not locked, the chair may move and the customer may get injury.

## 4 If necessary, press the UP / DN (DOWN) switch briefly (pressing for one second or shorter) to adjust the height of the backrest.

※ For instructions on moving up/down the chair, see the instructions manual for each chair.

## 5 Provide a shampoo service etc.

- 6 Turn the faucet handle after shampooing to stop hot water completely.  
When you store hot water, remove the trap cap, and then flush it down completely.
- 7 Supporting the customer's head, return the backrest.

 <b>CAUTION</b>	<p>Do NOT greatly turn the chair with the upper unit connected or with the top panel swing of the floor unit open.</p> <p>Failure to follow this instruction may cause the units to come in contact with one another and be damaged.</p>
---	--

## ■ Release The Connection Of The Upper Unit And The Floor Unit

- 1 Pull the connection release lever up while depressing the connection pedal.

The connection pedal moves up and the connection is released.

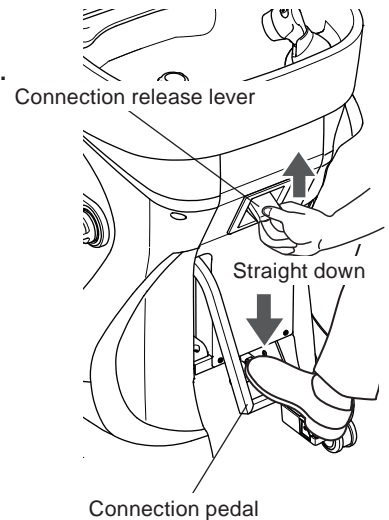

 <b>CAUTION</b>	<ul style="list-style-type: none"> <li>• Do NOT attempt to force to move the upper unit with the floor unit connected. Water may leak from the piping or the piping may be broken down.</li> <li>• If the upper and floor units are connected and left as they are after the completion of providing a shampoo service and if the water leaks from the hot water supply coupler, a small amount of water continuously may leak, resulting in a water leak accident.</li> <li>• Before disconnecting the upper and floor units, fully drain the water in the basin of the upper unit. If water stored in the basin is left as it is, the damage to the floor may become severer in the event of water leakage.</li> <li>• Do NOT pull the connection release lever up without stepping on the connection pedal. It may cause release failure or damage the unit.</li> </ul>
---	--

<b>Note</b>	<ul style="list-style-type: none"> <li>• The piping connection part has the mechanism that the valve blocks the flow path after the connection is released. However, a tiny amount of water droplets may fall into the floor unit, which does not cause a problem. Use it as it is.</li> <li>• Do NOT get the connection released immediately after finishing a shampoo service. Having drainage water in the upper unit may cause nasty smell and water leakage.</li> </ul>
-------------	--

- 2 Move the upper unit slowly.

 <b>CAUTION</b>	<ul style="list-style-type: none"> <li>• Disconnect them, slowly move the upper unit. When the unit is rapidly moved, the speed at which the top panel swing closes becomes faster and its impact may damage the parts.</li> <li>• Do NOT move with water stored in the basin.</li> </ul>
---	---

- 3 Stepping on the top panel swing to lock.

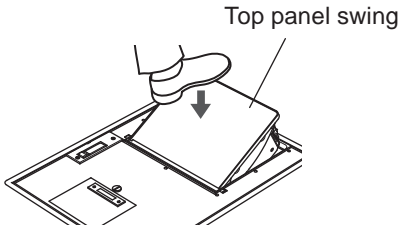
 <b>CAUTION</b>	<ul style="list-style-type: none"> <li>• Securely step on the top panel swing. If the step-on amount is insufficient, the top panel swing may not close.</li> <li>• Do NOT step on the top panel swing with any objects in the sump. The objects in the sump may get caught between the sump and the top panel swing, causing the top panel swing not to close or the equipment to be damaged.</li> </ul>	 <p>Label in diagram: Top panel swing</p>
---	---	--



**Note**

Lock mechanism of top panel swing has pedal reserve.  
The head of top panel swing can be appeared above the floor with lock position but it is not faulty

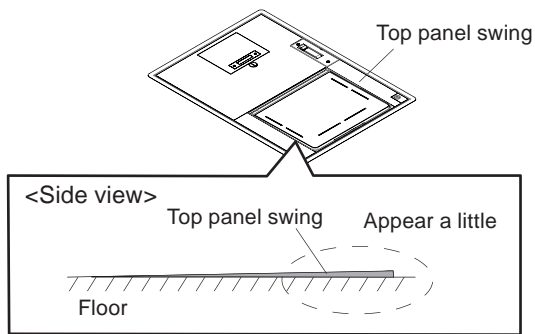

**4 After use, wipe off moisture and chemicals from the equipment and the floor.**

- Moisture and chemicals on the outer surface of the basin

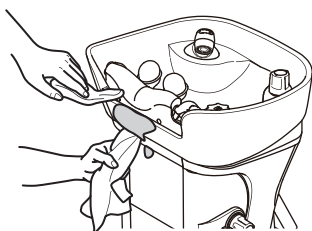

Wash off any chemicals, such as hair coloring agents, with water from the inner surface of the basin.

- Moisture and chemicals on the covers

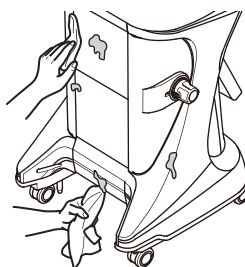

- Moisture and chemicals on the floor

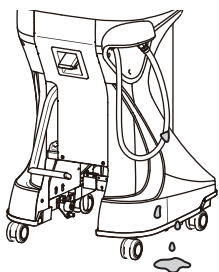

- Dropped water on the floor unit

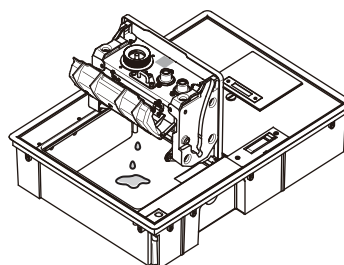





**CAUTION** After use, always wipe off moisture on other than the basin. Leaving the unit with water on it may cause damage to the main body, and make dirt difficult to remove.

**■ How To Use Spa Shower Head**

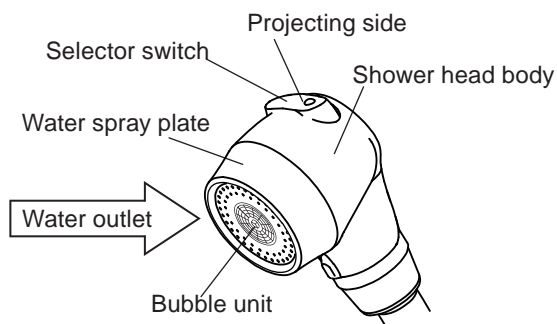
Changing the selection switch position switches between Shower Mode and air Low Splash Foaming Mode.



<p>&lt;Shower mode&gt;</p> <p>Press the projecting side of the selector switch.</p> 	<p>&lt;Bubble mode&gt;</p> <p>Press the flat side of the selector switch.</p> 
--	---



- After using the shower head, return it to the shower head holder. Place it back into the bracket so that the protrusion on the shower head matches the recessed portion on the bracket.
- Do not discharge a strong water stream when the shower head is in the shower head bracket. Failure to take this precaution may result in system failure due to spilled water or damage to the floor.
- Even after the water shower is suspended, water may drip. This is just a phenomenon that water remaining in the shower head keeps flowing to the underside of the water outlet, not a problem in the product. However, if water never stops flowing, the whirligig of the stop valve may be degraded.

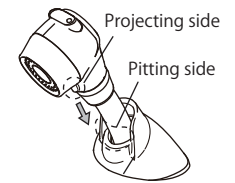

Shower head holder

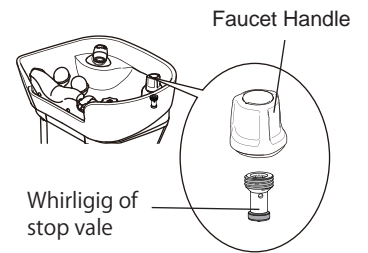

**Note**

If the shower head cannot be smoothly pulled out, it becomes smooth by making the hose wet with water.

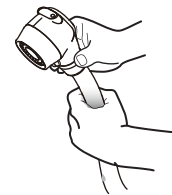

## ■ How To Adjust The Amount Of Outgoing Water

When the faucet handle is turned to the left (counterclockwise), warm water comes out from the shower head. The more the handle is turned to the left, the more the amount of warm water will increase. When not in use, turn the faucet handle securely to the rightmost position (clockwise) to ensure the warm water stops.

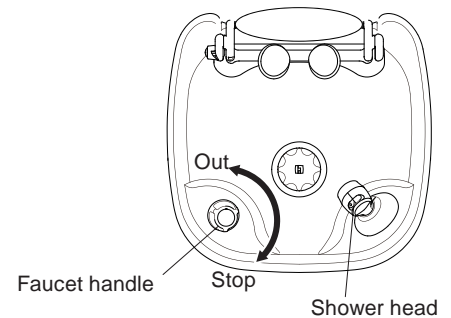

- When not in use, turn the faucet handle securely to the rightmost position (clockwise) to ensure the warm water stops. Failure to completely stop the water may cause water leak accidents.
- Note that if the faucet handle is turned to the leftmost position (counterclockwise) applying any excessive force, the handle may be locked and water may be unable to stop.
- After the completion of work, do NOT block the drain port with the trap cap, towels, or shampoo cloths. If the water accidentally flow or a small amount of water flow due to the increase of water pressure at night while the trap cap is covered, water leakage may occur. Failure to take this precaution may result in contact between the metal and the faucet handle resulting in flaws or cracks on the plated surface and thereby causing peeling of the plating.
- Check that there are no flaws, cracks, or peeling of the plated surface of the knobs before using the product. If peeling is observed, immediately stop using the product and contact your closest dealer or TAKARA BELMONT. Continued operation may result in injuries.
- The faucet handle may become stiffer when turned depending on the environment or condition that it is used in. This is due to deterioration of packing of movable parts or a lack of grease as a result of aging.

**Note**

The faucet handle may become stiffer when turned depending on the environment or condition that it is used in. This is due to deterioration of packing of movable parts or a lack of grease as a result of aging.

## ■ Temperature Adjustment Of Hot Water

- 1 Turn the temperature control handle to H (hot) or C (cold) direction and stop it at the desired position. Turning the faucet handle toward left (counterclockwise) will make the water hotter, and turning it toward right (clockwise) will make it colder.

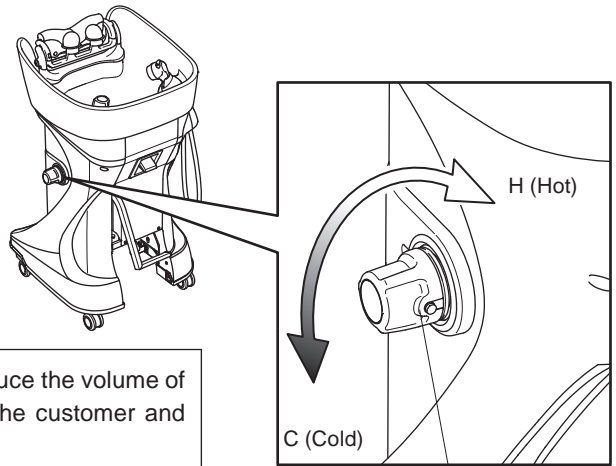

**CAUTION**  When adjusting the water temperature, reduce the volume of water, point the shower head away from the customer and check the temperature by hand. Take care when doing so, as hot water may come out of the shower head.

- 2 The temperature control handle stops at a point; temperature adjustment lock position as the right figure. For using hot water at high temperature (40 °C or more), turn the temperature control handle to the H (hot) direction while pressing the stopper button.

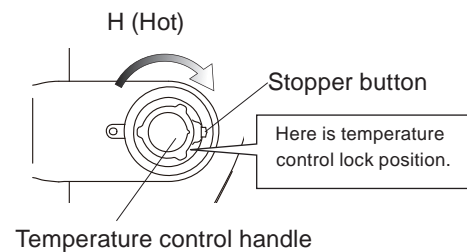

**WARNING**  • Before supplying water, check the set temperature position of the temperature control handle. Failure to follow this instruction may cause hot water to come out and burns. In addition, if you shampoo the customer's hair at a temperature higher than that of the temperature control lock position, do NOT operate the temperature control handle during the shampoo service. Failure to follow this instruction may cause improper operation by which hot water splashes onto the customer's head and the customer may get burned.

• If you have turned the handle to a temperature higher than that of the temperature control lock position, be sure to return it to the temperature control lock position after use. If you keep using the equipment at the temperature, hot water may splash onto hands and heads, causing burns.

**CAUTION**  • Before turning the faucet handle, take off metals, such as rings and watches. Failure to follow this brings such metals into contact with the top surface (cap) of the faucet handle, which results in flaws and cracks on the plated surface, causing separation of the plating.

• Before using, check that there are no flaws, cracks, or separation of plating on the plated surface of the temperature control handle.

※ Note that hot water at about 49°C or more is not available with this product to ensure safe operation. (Conditions: Same supply pressure, water temperature 20°C, Hot water temperature 60°C)

**Note**

- Output volume or hot water temperature may be significantly changed depending on your operation environment. This phenomenon causes the followings:
  - Hot water temperature out of the recommended temperature; 60°C to 80°C.
  - Significant difference of the height or pressure of water/hot water supply.
  - Use the multiple products simultaneously.
 However these phenomena are not product problems. You can specify the temperature of hot water to 40°C by using the lock function.
- The hot water adjustment lock position may not reach to 40°C depending on using environment, however this is not a problem. This lock is an auxiliary function to prevent the too hot water supply.

## ■ Store Hot Water

To accumulate hot water for emulsification of hair color, rotate the drain cap in the clockwise direction to close the drain outlet.

Set the amount of warm water to the ..... line (limit water level) or below (at the mounting surface of the shower head holder or below) in the following figure.

If warm water is stored above the ..... line, warm water spills out through the shower hose outlet.

Stored water can be drained by turning the trap cap counterclockwise to open the drain port. Then you can drain water.

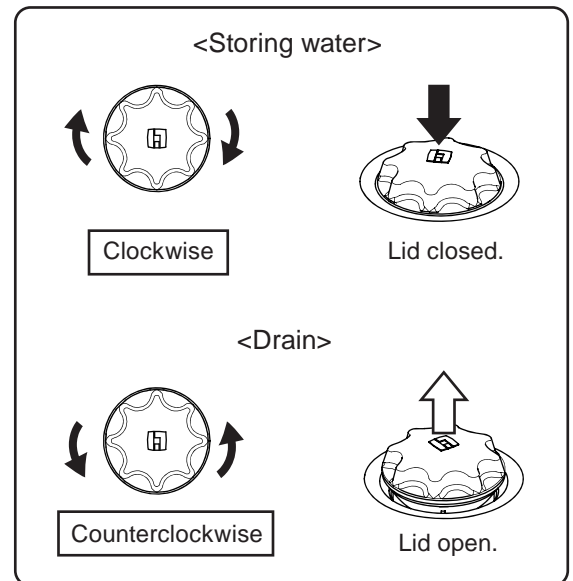
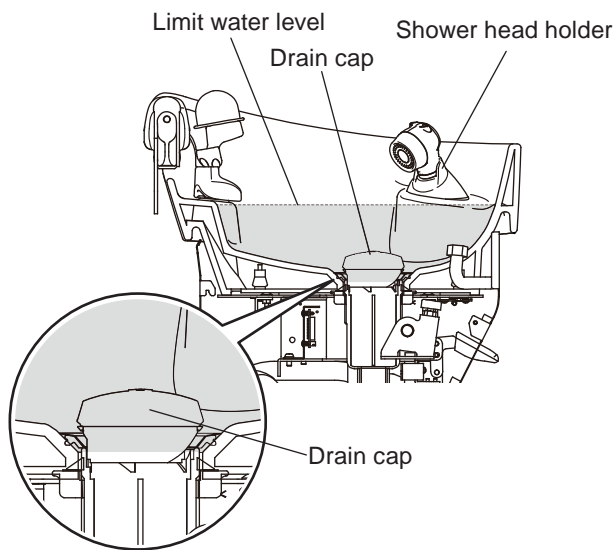

### CAUTION

- Do NOT leave the shower head in the stored warm water. If the pressure in the water service pipe decreases due to a water failure etc., a back flow of warm water may occur.
- If water does not drain smoothly, the hair trap and the drain coupler may be clogged with waste. In that case, remove waste in the hair trap and the drain coupler. Refer to *Maintenance Of Hair Trap* on page 27 and *Maintenance Of Drain Cap* on page 30 to 32.

### CAUTION

- When not in use, remove the trap cap from the drain port and always put it in place outside the basin. If the trap cap is not removed, water may overflow, causing water leak accidents.
- This product does not have overflow mechanism and, if the warm water is left flowing with the drain port blocked with the trap cap, water may overflow from the basin and make the floor, furniture, clothes, etc., dirty.

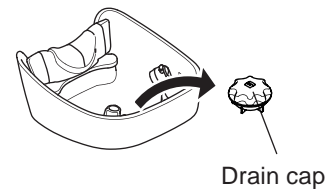

### Note

A trace amount of hot water may be remained after storing the hot water. The trace amount of water may flow, however, this is not be constitute an obstacle to your work. If the amount of remained water increase significantly, the deterioration or chafing fatigue of drain cap or packings. Need to change the drain cap (on a chargeable basis).

## ■ How To Fix The Neck Device

(for intermediate rinsing with water in permanent waving)

<Only Back Wash Basin (YUME Basin)>

Before laying the customer, make the following preparations.

1. Turn the head pillows area as shown in the figure below.

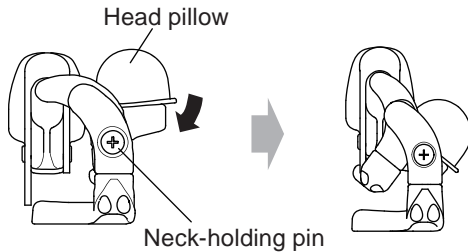

2. Press the neck-holding pin.

Check that the neck-holding pin pressed from the outside comes out inside.

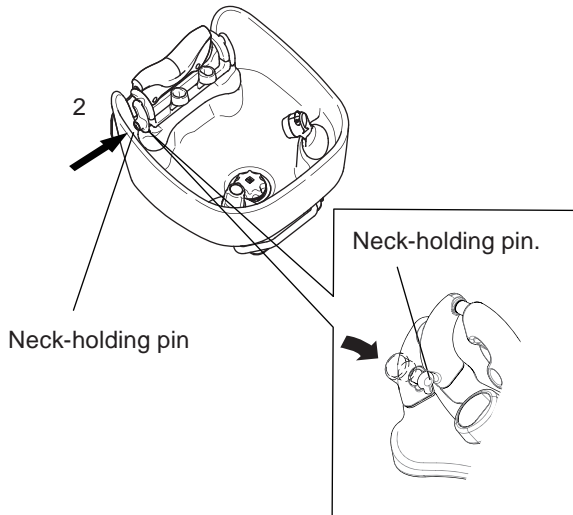

3. Turn the neck-holding pin pressed out inside clockwise to lock it.

4. Remove the head pillows.

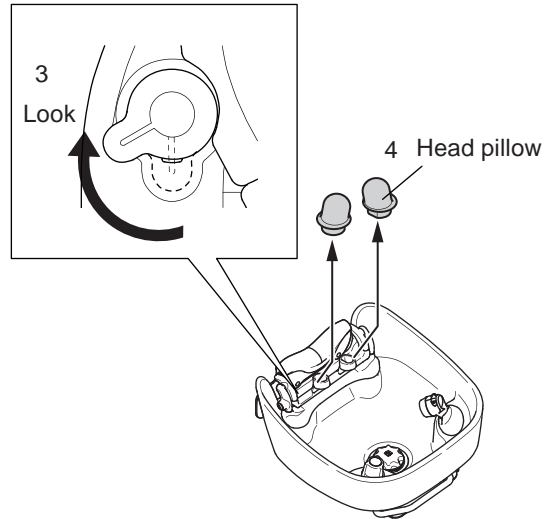

**CAUTION**

When using the neck device in a fixed state, be sure to lock the neck-holding pin. When using the equipment without locking the neck-holding pin and if the locked neck device is released during the service, the customer may hit his/her head against it and become injured.

## ■ How To Return The Neck Device To The Normal State

Before laying the customer, make the following preparations.

1. Attach the head pillows.
2. Turn the head pillows area as shown in the figure below.

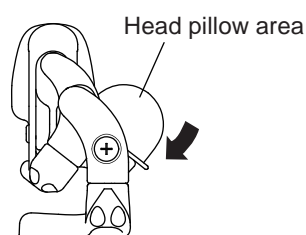

3. Turn the neck-holding pin counterclockwise to release the lock.

4. Push in the neck-holding pin.

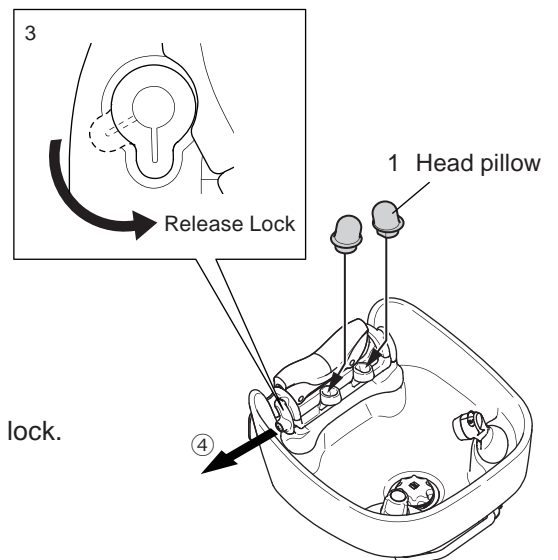

## ■ Basin Breakage Prevention Tilt Mechanism only for Back Wash Basin (YUME Basin)

If the chair is moved up/down or reclined/returned with the upper unit connected to the floor unit, the backrest and the basin may collide with each other and the basin may break.

When the basin collides with the backrest, the basin tilts backward a certain amount to prevent the basin from breaking.

When the basin is tilted, an alarm with a high-pitched waring tone keeps sounding.

On this occasion, if you operate it manually, release the switch.

For the automatic operation mode, press the switch again to stop the automatic operation.

Then move down the chair manually.

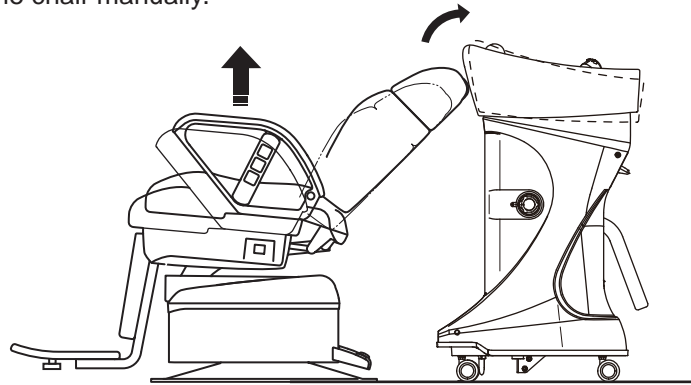

- Do NOT bring the backrest of the chair into contact with the basin to deliberately attempt to trigger the basin breakage prevention tilt mechanism.
- When moving down the chair, do NOT use the auto-return function. The backrest returns first, which further lifts the basin, causing damage to the equipment.

As the power supply for the above-mentioned sound, the Back Wash Basin (YUME Basin) uses dry cells (two AA cells) are used. Cells are consumables.

If the alarm does not sound even after the front of the basin is tilted or the alarm changes, the cells reach the end of their lives. Replace the cells. (See *How to replace the cells* on page 23.)

Guideline at a low battery level

The alarm in the case where the battery level remains: Continuous high-pitched tone.

The alarm in the case where the battery level does not remain: Intermittent high-pitched tone.



- Replace the cells periodically (about once every two years) as the liquid inside may leak depending on the usage environment, which causes damage to the equipment.  
(See *How to replace the cells* on page 23.)
- Do NOT charge, disassemble, short-circuit, throw in a fire, nor heat the cells, or a liquid leakage or explosion / heat generation may occur. In addition, do NOT reversely connect the positive (+) and negative (-) sides, mix different kinds of cells\* or new and old cells, give an impact, nor pressurize to deform.  
※Different kinds of cells: Alkaline cells, manganese cells, rechargeable cells, etc.
- Do NOT reversely connect the positive (+) side and the negative (-) side of the cells. Failure to follow this instruction may damage the equipment.
- If liquid leaks, immediately remove the cells and wipe off the leaked liquid. In addition, if the leaked liquid gets into your eyes or adheres to your skin/clothing, it may cause blindness or injury. So wash it away with a large amount of clean water and go to a doctor for treatment.
- The cells have the recommended expiration date. Cells after the expiration date may not work properly even if they are new.
- Reusable rechargeable cells (1.2 V) may run out faster than alkaline cells etc.



## ■ How To Replace The Cells

1. Remove the maintenance cover of the upper unit.  
(See *Removal procedure* on page 30.)

2. Apply your finger to tab of the battery box cover to detach the battery box cover.

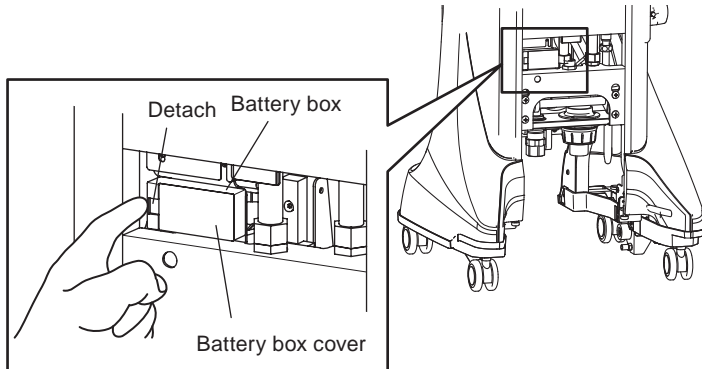

3. Remove the cells.

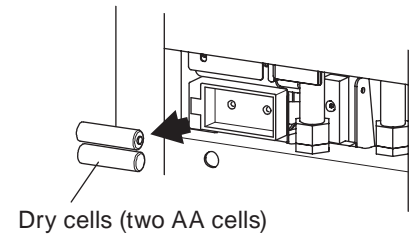

○ This product uses two AA batteries.

4. When setting cells in the cell box, enter the date of setup in the cell replacement label.

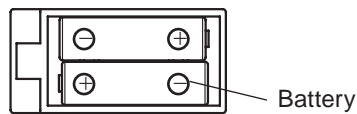

5. Close the battery box cover.

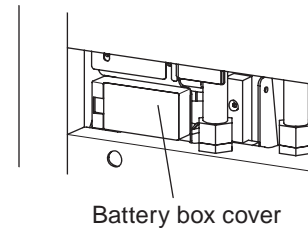

- Wrong setting may cause battery leakage or rupture.
- Do not use a new battery and an old battery simultaneously. This may occur the liquid leakage or damaging.

Note

When setting cells in the cell box, write the date of setup in the cell replacement label. It can be the rough guide to replace the batteries next time.

Battery replacement label.

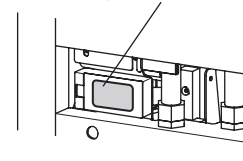

6. Lift the end of the basin, and check that an alarm with a high-pitched tone sounds. If it does not sound, check the direction of the cells you set up.

7. Attach the Maintenance cover of upper unit.  
(See *Attachment procedure* on page 32.)

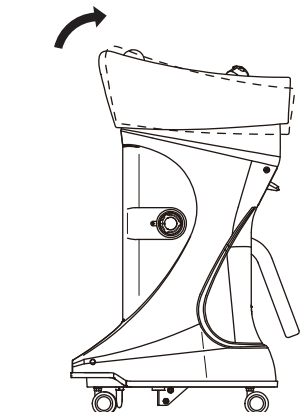

# What To Do After The Close Of Business

## Prevention Of Water Leak Under Floor

※ Always close the water stop valve after the close of business to prevent water from leaking.

- 1 While holding the rotary knob of the maintenance lid, open the maintenance lid.
- 2 Close the water stop valves for both warm and cold water.

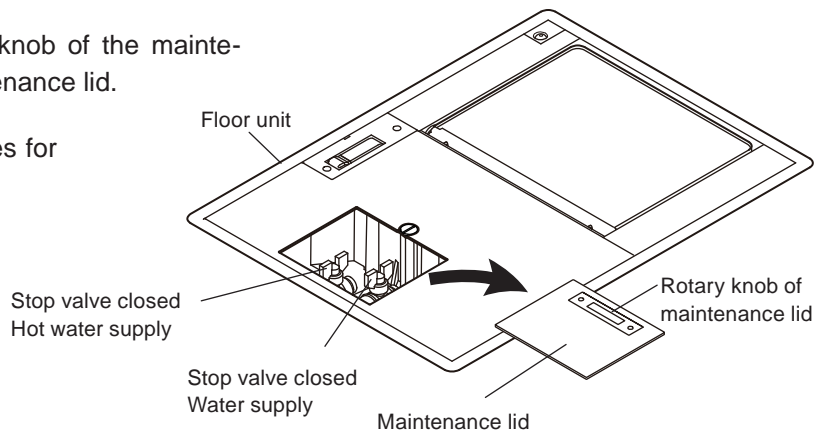

The pipe connected to the water stop valve for supply of warm water is at a high temperature. Do NOT touch directly.



Stop valve closed



Stop valve open

## Prevention Of Condensation Inside The floor unit

<Prevention of condensation inside the floor unit>

- ※ Moisture around the floor unit causes condensation inside, resulting in water accumulation within the floor unit. Remove the maintenance lid after the close of business. It is effective for prevention of condensation.

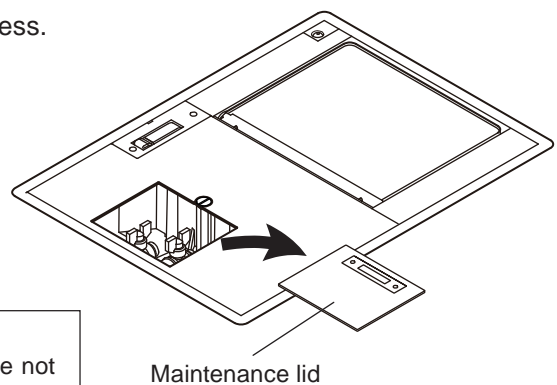

CAUTION

When the maintenance lid is open, take care not to get your foot caught in or fall into the hole.

# Maintenance

## Maintenance Map: Upper Unit

Back Wash Basin (YUME Basin)

Side Wash Basin

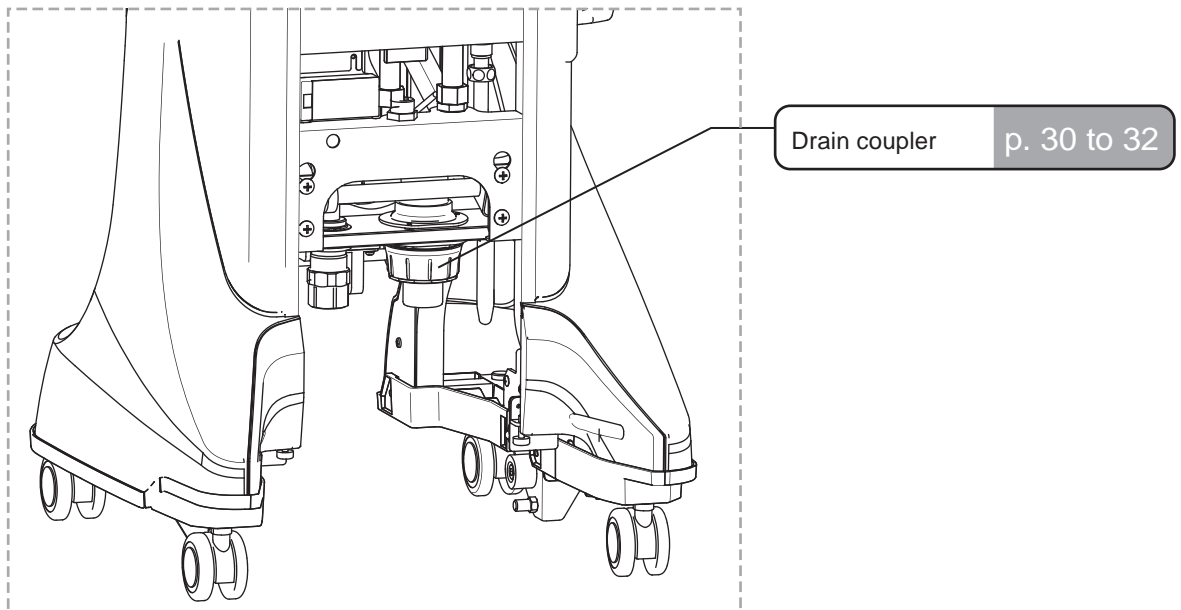
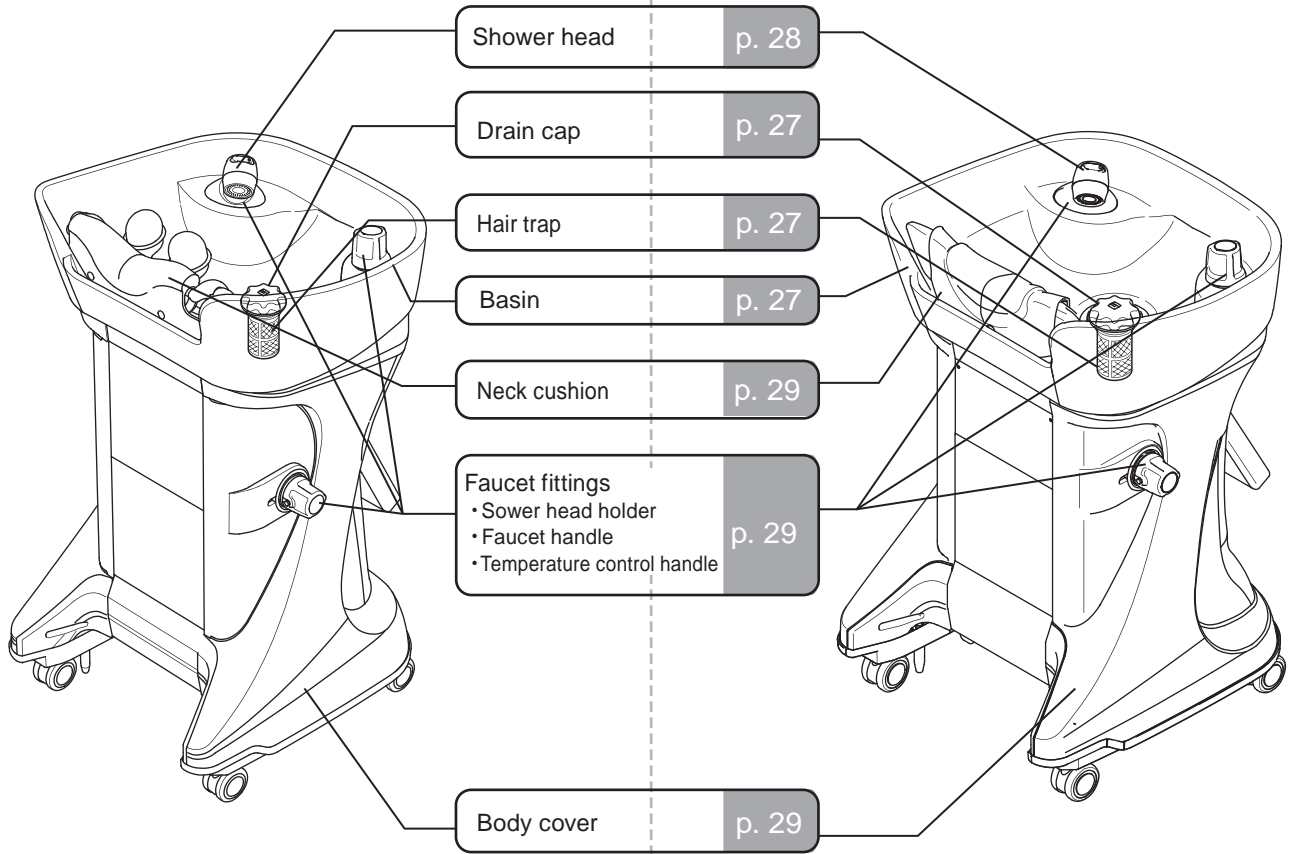

## Maintenance Map: Floor Unit

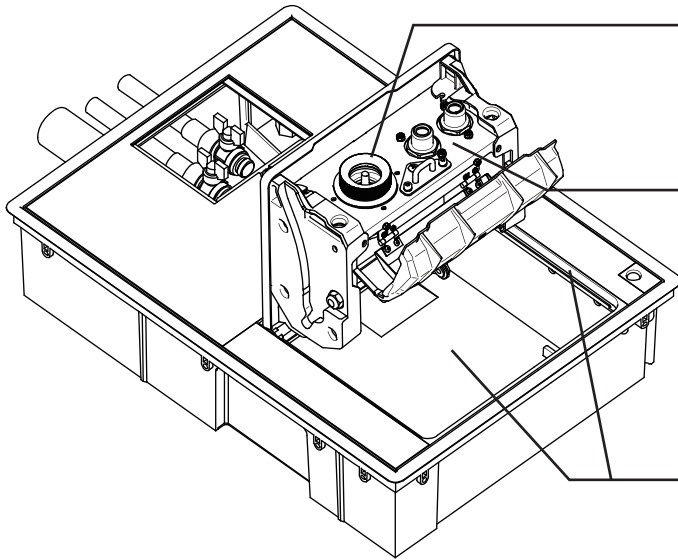

Drain cap  
Drain coupler

p. 34 to 36

Coupler for hot water supply

p. 34

Sump and sash

p. 34

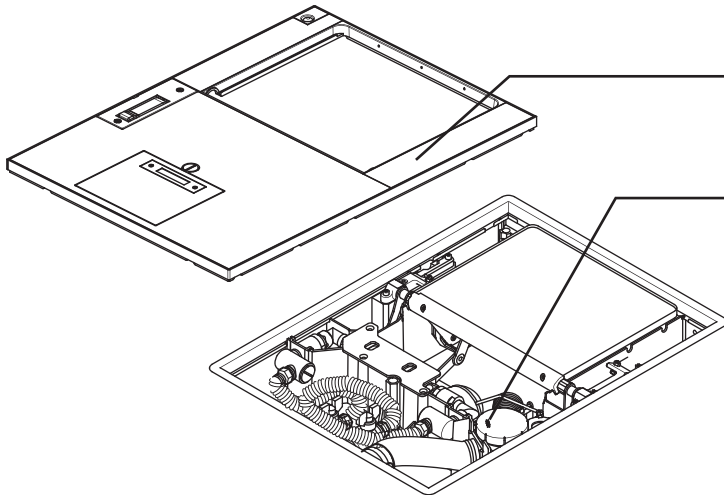

Connection release lever

p. 33

Drain trap

p. 37 to 38



### Cleaning point

If you would like to clean throughout the floor unit, we recommend using commercially available vacuum cleaner for dry and wet use. In addition, when using a vacuum cleaner, we also recommend using the optional cleaning kit too.

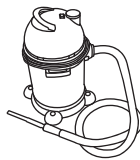

#### Cleaning kit



Cleaning nozzle



Vacuum cleaner adapter



Syringe



CAUTION

In cleaning this product, water need to be vacuumed. Therefore, when using a vacuum cleaner, be sure to use a vacuum cleaner for dry and wet use.



CAUTION

Never use volatile chemicals, such as thinner, alcohol, gasoline, and kerosene, wax containing abrasives, sponges containing abrasives, detergents containing organic solvents, acidic, alkaline, and chlorine-based detergents, scrubbing brushes, or other cleaning tools. Failure to follow this instruction may cause scratches or discoloration.

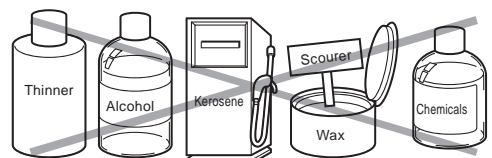

## Maintenance Of Basin

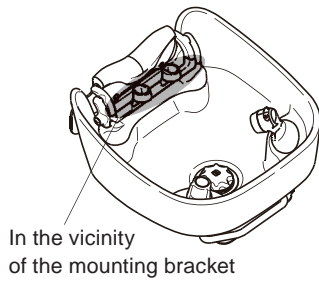

Dilute a synthetic detergent with approx. ten parts of water and wipe off dirt. If streaked scratches appear due to contact with metallic objects such as watch bands, rub the area with a nylon scourer. Carefully clean around the neck cushion and head pillow attachment tools with an item such as a cotton-tipped swab.

**CAUTION** Do NOT use metal scrubbing brushes, sandpaper, etc. because they cause flaws.

Pull out the hair trap located under the drain cap and remove any hair that has been caught.

Maintenance frequency	Every day
-----------------------	-----------

## Maintain The Hair Trap

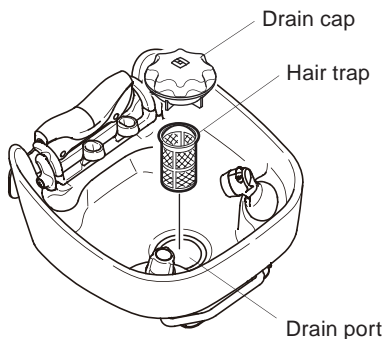

Take out the hair trap under the drain cap and remove hairs from the hair trap. The hair trap is a consumable supply. Replace the hair trap if it is extremely dirty or the surface has deteriorated. (available at additional cost)

Maintenance frequency	Every day
-----------------------	-----------

**CAUTION** Clean the hair trap as often as possible. If using the hair trap not cleaned, it may cause clogging of the port, overflow or poor sanitary. Cleaning the hair trap every after each shampooing is recommended.

**CAUTION**

Do NOT flush away hair on the hair trap or on the basin into the drain port. In addition, do NOT shampoo customer's hair with the hair trap removed. If you flush away hair into the drain port, hair builds up at the connection of the upper and floor units, causing a water leak or bad connection.

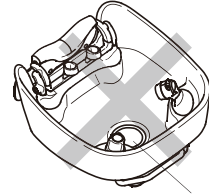
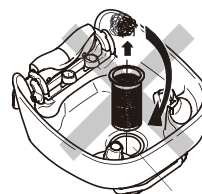

## Maintenance Of Drain Cap

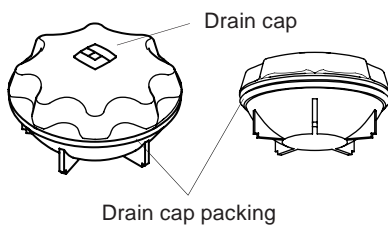

Wash the areas around the packing attached to the outer periphery of the trap cap without using a soap to remove hair and dirt caused by chemical agents etc.

The drain cap is a consumable supply. When water stored in the basin drains faster due to its deterioration etc., replace it (on a chargeable basis).

Maintenance frequency	Every day
-----------------------	-----------

**CAUTION**

- When not in use, always remove the trap cap from the drain port. If the drain cap is not removed, it may close accidentally and, if you do not notice water coming out, the water may overflow from the basin, causing water leak accidents.
- The drain cap should be handled carefully. It may break if it is dropped.
- The drain cap packing is fixed on the drain cap. If you try to remove it forcibly, the packing may be damaged and the water in the basin may decrease at a faster pace.

## Maintenance Of Shower Head

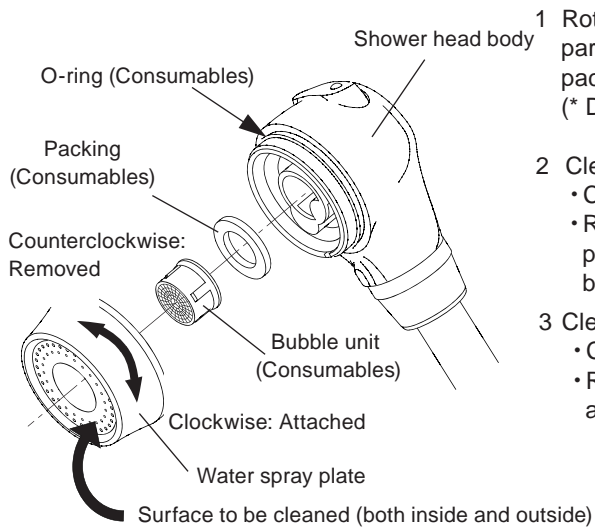

- 1 Rotate and detach the sprinkling filter unit and remove the three parts (sprinkling filter unit, foaming water outlet, and rubber packing).  
(\* Do NOT remove the O-ring.)
- 2 Clean the water spray plate (by washing without using soap).
  - Clean the water spray plate once a week.
  - Remove dirt, such as water scale, on the hole of the water spray plate from which water comes out in the shower mode using tooth brushes etc.
- 3 Clean the bubble unit (by washing without using soap).
  - Clean the bubble unit once a month (as a guideline).
  - Remove dirt, such as water stain on the foaming water outlet, with a toothbrush.

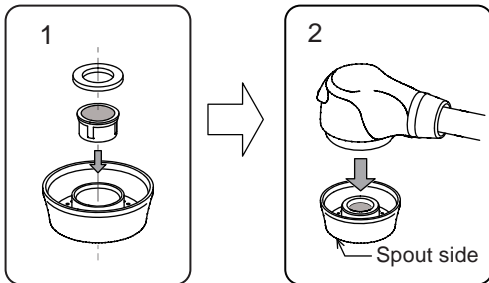

Wash the bubble unit in the direction as shown in the figure.

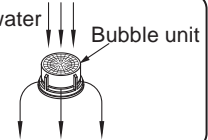

- 4 Reassemble.  
<Assembling procedure>
  1. Insert the foaming water outlet and the rubber packing in the sprinkling filter unit in this order.
  2. With the water supply side of the water spray plate facing down, attach the water spray plate to the shower head body.



When not periodically cleaning the bubble unit, it may clog and cause an unusual squealing noise from the shower head.

Maintenance frequency	Every week
-----------------------	------------

## Maintenance Of Drain Stopper Rubber Only For Back Wash Basin (YUME Basin)

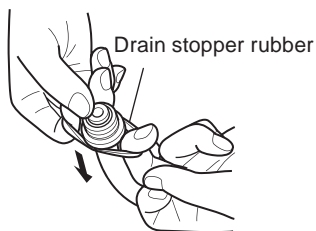
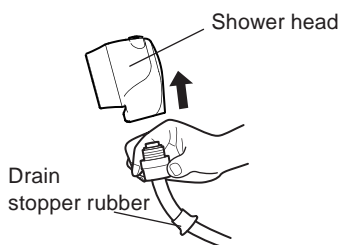

At the end of work each day, wash with water to remove any hair or chemicals.

If it becomes unable to fix or slippery, or its surface deteriorates, replace it (on a chargeable basis).

### How to replace

Maintenance frequency	Every day
-----------------------	-----------

1. Remove the shower head.
2. Remove old tickle stopper rubber.
3. Spread open the new tickle stopper rubber with both hands and fit it on to the hose.
  - The most effective attachment position is approximately 10 cm from the base of the shower head.
4. Attach the shower head.
  - Replacement is easier if performed by two people.  
The rubber may expand slightly during replacement, however it will contract and secure itself after some time.



## Maintenance Of Faucet Fittings (shower head holder or stop vale)

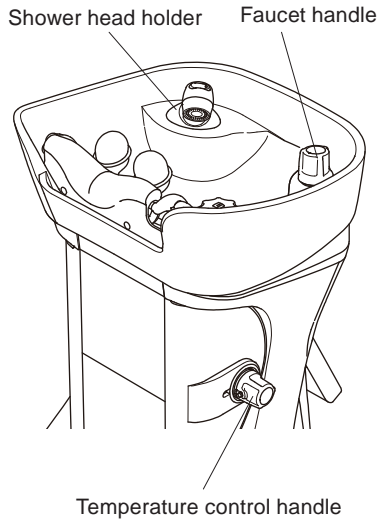

Wipe off dirt with a soft cloth or towel moistened with a solution made by diluting a synthetic detergent with approx. ten parts of water.



- Do NOT use sponges as even sponges intended for home use may damage the surface when used repeatedly.
- Do NOT use abrasives, sponges with abrasives, metal scrubbing brushes, nylon scrubbing brushes, etc., as they may damage the surface.
- Do NOT use chlorine-based, acidic, alkaline, or other chemical agents for stubborn dirt as they may cause separation of plating on the surface.
- If there are separation or flaws on the plated surface of the temperature control handle / faucet handle (resin-plated parts). Your hand may become injured by the separation or the flaws on the plated surface.

Maintenance frequency	Every day
-----------------------	-----------

## Maintenance Of Neck Cushion

\* Neck cushion is common in Back Wash Basin (YUME Basin) and Side Wash Basin.

After the close of business of the day, wash without using soap, fully wipe off moisture with a dry towel, and then dry in the shade.

For tough dirt, wash it with a solution made by diluting a synthetic detergent with approx. ten parts of water, and then wash it away with an adequate amount of water.

The neck cushion and the head pillows are consumables.



- If a chemical agent adheres to the neck cushion, immediately wash it away. Failure to follow this instruction may cause deterioration/discoloration.
- Maintain the neck cushion every day. If the dirt is left as it is, it may cause fungi.

Maintenance frequency	Every day
-----------------------	-----------

## Maintenance Of Body Cover

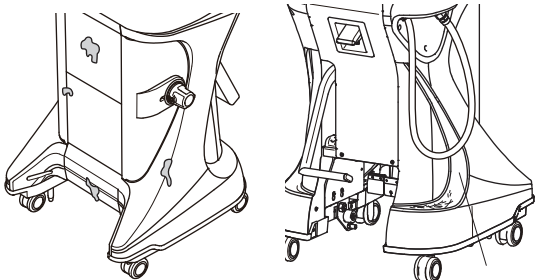

Remove moisture and chemical agents on the covers, and a buildup of hair and waste on steps of the cover. Then wipe with a dry, soft cloth.

For tough dirt, after wiping it off with a solution made by diluting a synthetic detergent with approx. ten parts of water, always wipe with a dry cloth.

Maintenance frequency	Every day
-----------------------	-----------



Never use volatile chemicals, such as thinner, alcohol, gasoline, and kerosene, wax containing abrasives, sponges containing abrasives, detergents containing organic solvents, acidic, alkaline, and chlorine-based detergents, scrubbing brushes, or other cleaning tools. Failure to follow this instruction may cause flaws, discoloration, etc.

## Maintenance Of Drain Coupler Area

### 1 Remove the maintenance cover.

<Removal procedure>

The maintenance cover is mounted by slotting to the screws as shown in the image below. It is not required to remove the screws.

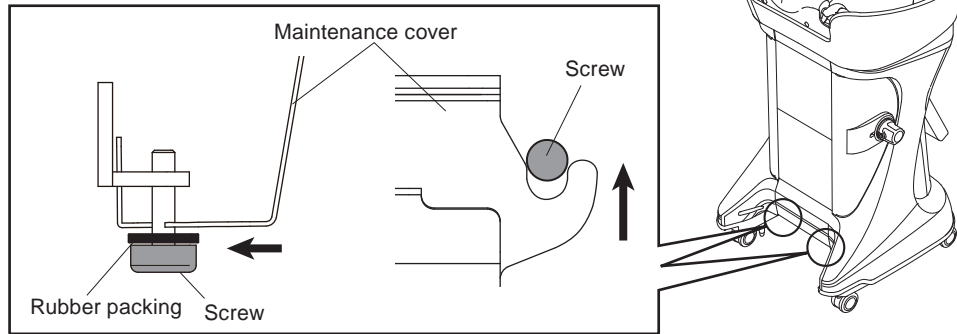

#### 1. Loosen screws (two positions: left and right).

※ Loosen the screws on the right and left sides one by one by hand.

※ Loosen the two left and right screws until the gap between the maintenance cover and the front cover becomes around 1 cm.

**CAUTION** Do not loosen the screws too much.  
The maintenance cover may drop off and the cover may be damaged.

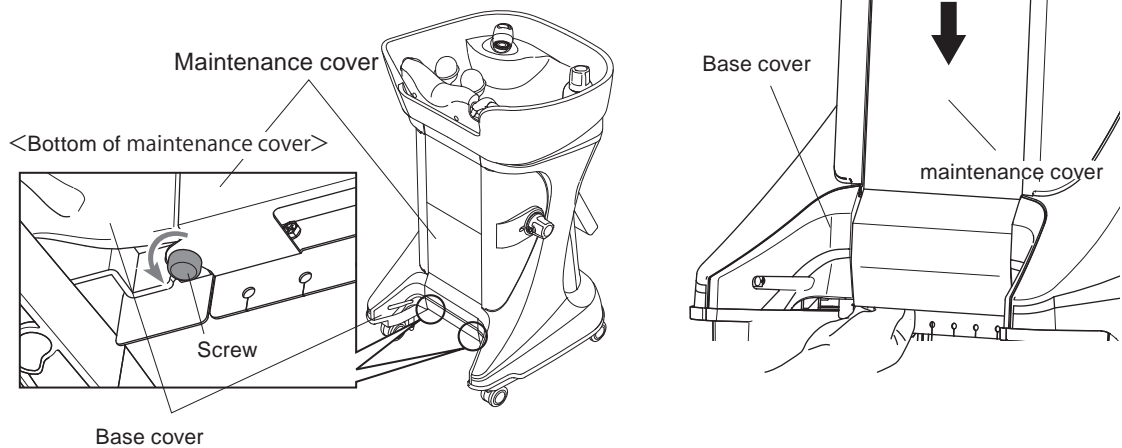

#### 2. Remove the maintenance cover.

Hold the bottom of the maintenance cover and pull it to remove.

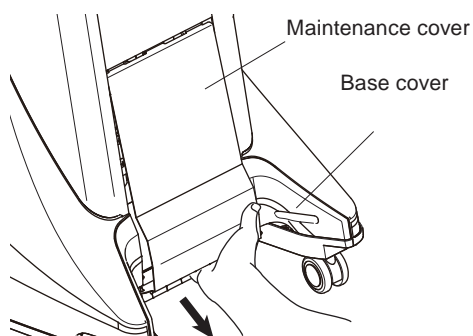

**CAUTION** Hold the bottom of the maintenance cover and pull it to remove.  
The base cover may be damaged.

## Maintenance Of Drain Coupler Area

- 2 Turn the drain coupler in the direction indicated by the arrow to remove it.  
When removing the drain coupler, water drops from the coupler.  
Therefore, prepare a bucket etc. before removing it.

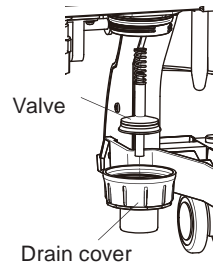
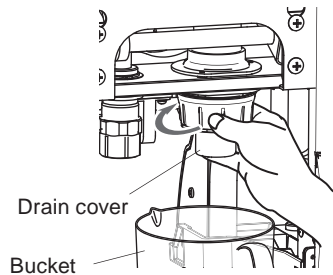

### Note

If the drain coupler is hard to turn, rubber gloves or sheets can be used to make it easier to turn.

Maintenance frequency	Every week
-----------------------	------------

- 3 Clean (wash without using soap) hair and dirt inside the drain coupler and on the packing of the valve.



- Valve has a spring. Take care not to lose it.
- Do not scratch the drain coupler valve strongly or scratch with the nail. It may cause damage to valve or a water leak from the valve.

Inside the drain coupler

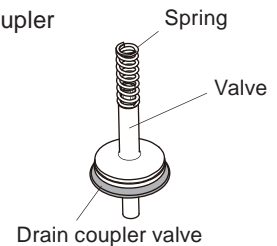
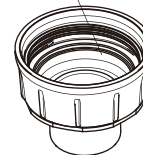

- 4 Insert the valve.

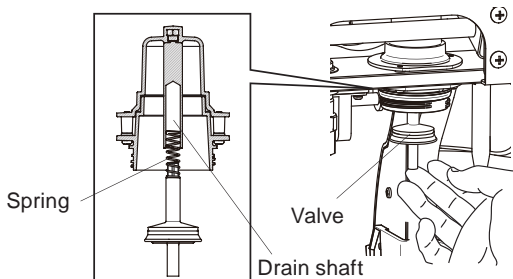

Insert the spring of the valve into the drain shaft. If it is not set in the drain shaft, it may cause damage to parts or a water leak from the drain coupler when connecting to the floor unit.

- 5 While holding the valve with your fingers to prevent it falling, attach the drain coupler.

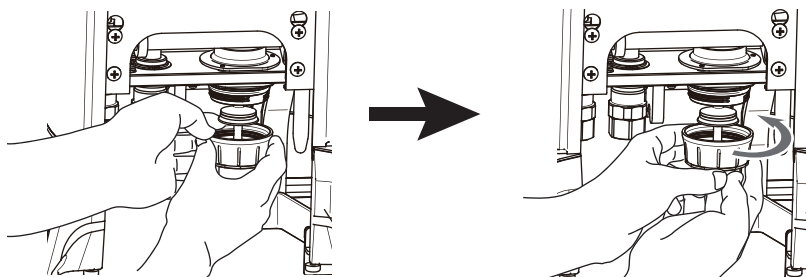

- 6 Press the valve end with your fingers to see if it returns.

If the valve does not return, the valve may not be in the drain shaft in Step 4.  
Remove the drain coupler and attach the valve again.



## Maintenance Of Drain Coupler Area

- 7 Attach the maintenance cover.  
<Attachment procedure>

1. Check that the screw is loosened.

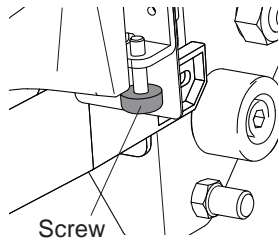

2. Insert the maintenance cover into the front cover.

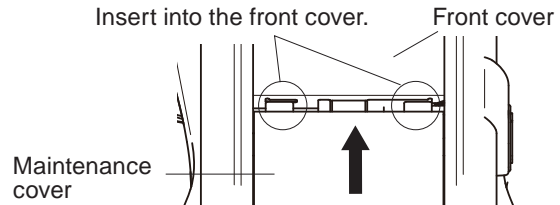

3. Hook the lower part of the maintenance cover onto the loosened screw.

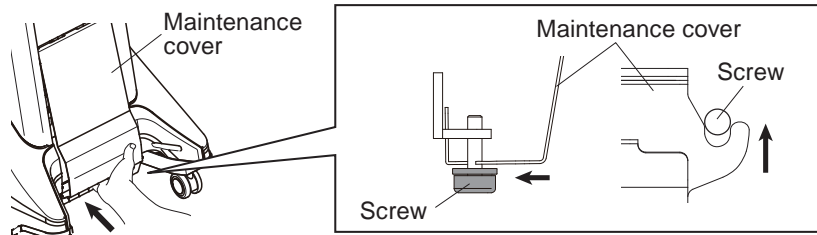

4. Tighten the screws (two positions: left and right) while the maintenance cover is pushed upward.

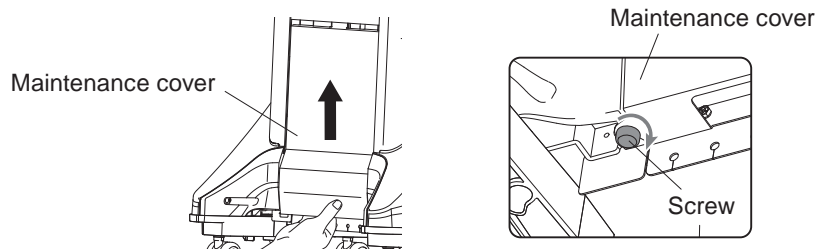

- CAUTION**  • Securely tighten the screws.  
If not, the maintenance cover may drop off, damaging the floor or the product.
- Do not connect the upper unit to the floor unit with the screws loosened.  
The top panel swing is interfered and the device may be damaged.

## Maintenance Of Down leak prevention cloth

At the end of work each day, remove stains from it and wring it dry.

Down leak prevention cloth is a consumable supply.

Replace the down leak prevention cloth if the velcro of it does not work well, or it is broken or it doesn't fit the shower hose firmly (available at additional cost)

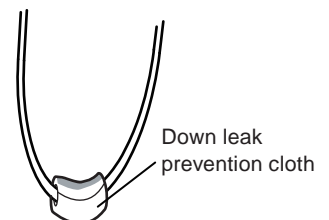

**CAUTION** 

Down leak prevention cloth doesn't absorb the tickle completely. It doesn't absorb moisture completely and it cause water dripping on the floor. Then wipe water away immediately. Leaving the water on it may cause damage to the main body and dipped water on the floor cause slipped and injured in a fall. As the case may cause water leakage accident.

## Maintenance Of Release Lever Area

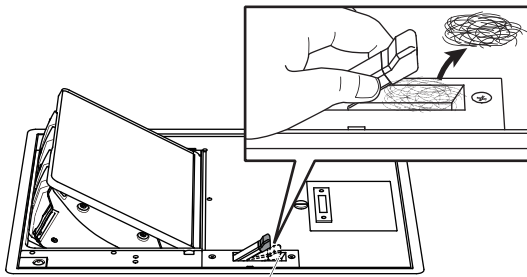

Connection release lever

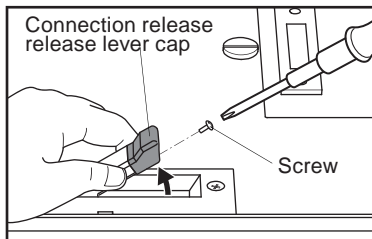

How to replace the release lever cap

- Remove hair caught under the release lever.

Maintenance frequency	For an increasing buildup of hair
-----------------------	-----------------------------------

- If the surface of the release lever cap deteriorates, replace it with the release lever cap (new one) supplied with the product.

1. Pull up the release lever and remove the screw at the top of the release lever cap.
  - ※The screw is used again. So take care not to lose it.
2. Pull out the release lever cap and replace it with new one.
3. Securely fix the release lever cap with the screw.
  - ※The release lever cap is a consumable.



CAUTION

Take care not to get your fingers caught in the gap of the release lever.

## Maintenance Of Inside Of Floor Unit

- Preparations for maintenance (set the top panel swing to the maintenance position.) -

1. Pull the release lever upward to open the top panel swing.
2. While holding the handle, open the top panel swing to the position at the right angle.
3. Fit the maintenance lid in the groove at the bottom of the floor unit along the side in the floor unit and press the maintenance lid against the bottom of the top panel swing you pulled up, leaving the top panel swing open. Confirm that the Top panel swing stands without hand.

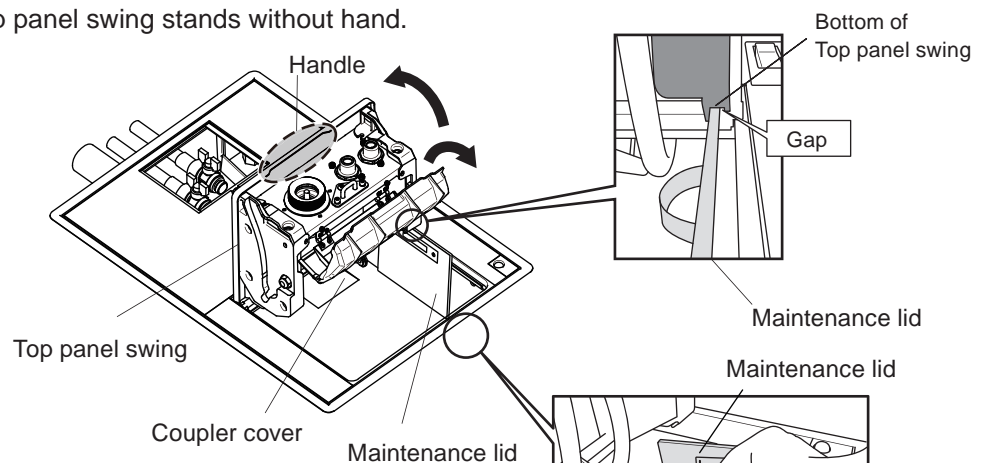
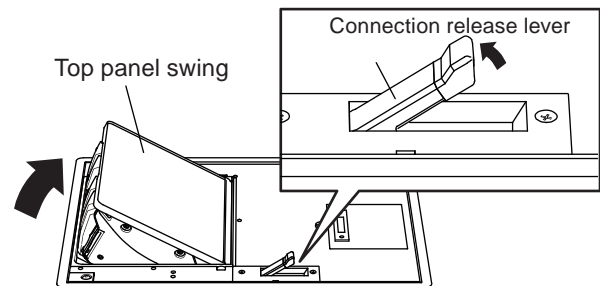

CAUTION

Do NOT hold any part other than the handle shown in the figure.  
If holding parts other than the handle, hands may be caught.

## Maintenance Of Inside Of Floor Unit

Set the top panel swing to the maintenance position (See *Preparations for maintenance* on page 33).

### Cleaning Of Sump And Sash

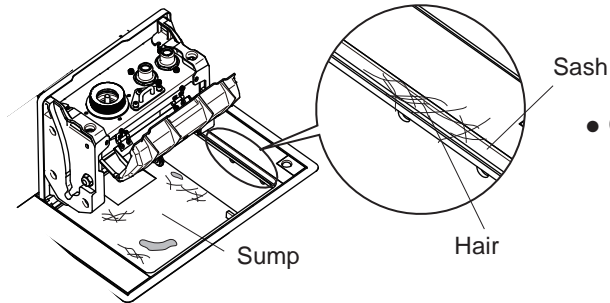

- Clean hair and waste on the sump and the sash. In addition, if water is stored, wipe it off.

Maintenance frequency	Every month
-----------------------	-------------

### Cleaning Of The Cold/Hot Water Supply Couplers And The Drain Cap

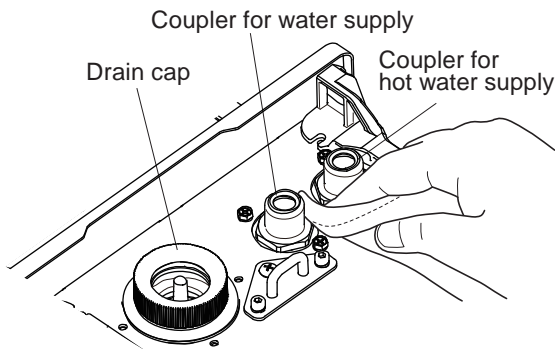

- Wipe off hair and water on the hot/cold water supply couplers and the drain cap and clean them.

Maintenance frequency	Every month
-----------------------	-------------



If hair adheres to the hot/cold water supply couplers and the draincap, the connection and water flow may have defects.

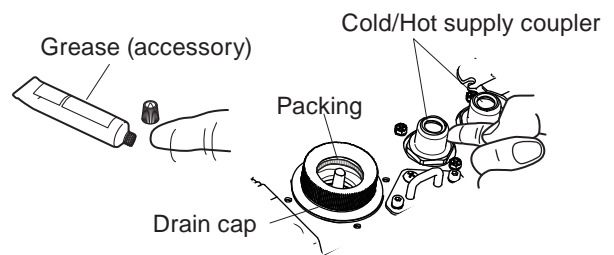

For longer life of this product, please grease up the hot water/water supply coupler with grease (accessory) when you feel difficulty in connection in the upper unit (connection of water/water supply pipes).

- ※ If the coupler is thickly coated with the grease, dust or the like may easily attach to the coupler.

Maintenance frequency	Once a year
-----------------------	-------------



Be sure to use the grease specified by TAKARA BELMONT. Using the other grease may cause malfunction in connection or water flow.



## Maintenance Of Inside Of Floor Unit

Set the top panel swing to the maintenance position (See *Preparations for maintenance* on page 33).

### Cleaning Of The Drain Coupler

- 1 Turn the drain coupler in the direction indicated by the arrow to remove it.  
When removing the drain cap, water drops from the cap.  
Therefore, prepare a towel etc. before removing it.

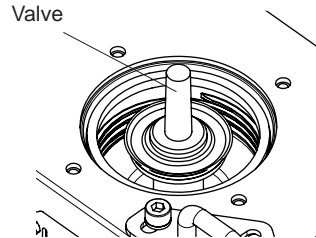
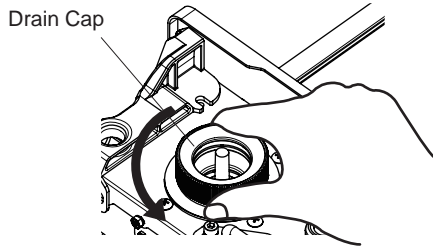

#### Note

If the drain coupler is hard to turn, rubber gloves or sheets can be used to make it easier to turn.

- 2 Clean (wash without using soap) hair and dirt inside the drain cap and on the packing of the valve.



- Valve has a spring. Take care not to lose it.
- Do not scratch the drain coupler valve strongly or scratch with the nail. It may cause damage to valve or a water leak from the valve.

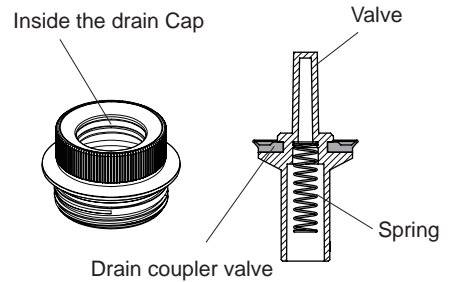

- 3 Clean hair and waste on the drain coupler.

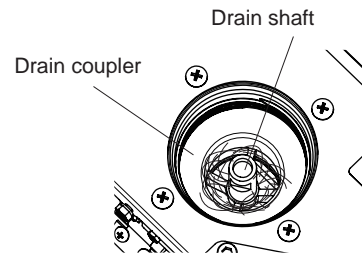

- 4 Insert the valve.



Insert the spring of the valve into the drain shaft. If it is not set in the drain shaft, it may cause damage to parts or a water leak from the drain coupler when connecting to the upper unit.

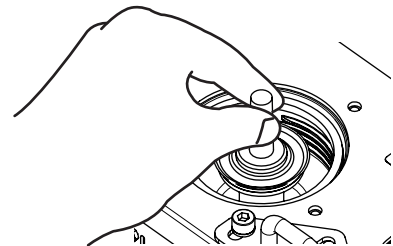

## Maintenance Of Inside Of Floor Unit

### Cleaning Of The Drain Coupler

5 Attach the drain cap.

  
CAUTION

If the drain coupler is hard to turn,  
remove the cap once, check whether the screw  
part is dirty,  
thinly apply the supplied grease.

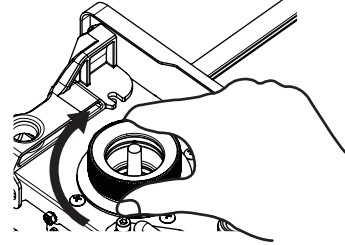
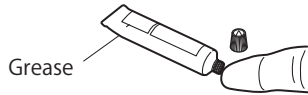

6 Press the valve end with your fingers to see if it returns.

If the valve does not return, the valve may not be in the  
drain shaft in Step 4.

Remove the drain cap and attach the valve again.

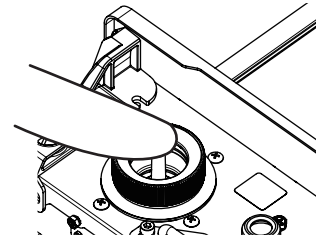

Maintenance frequency	Every month
-----------------------	-------------

## Maintenance Of Drain

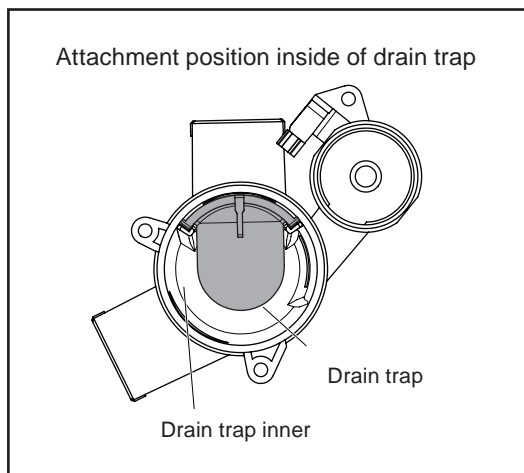
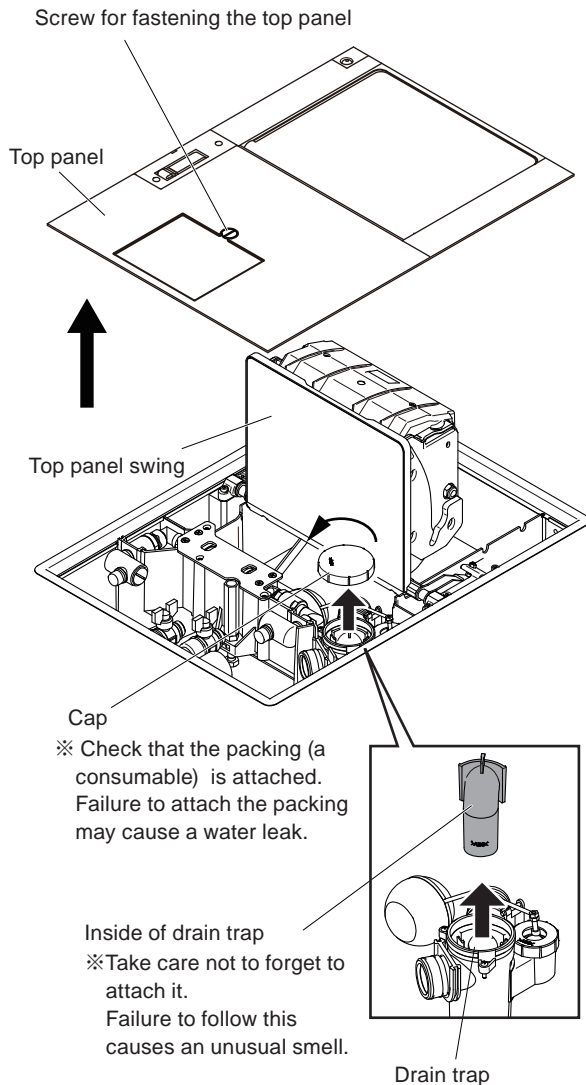

- 1 Set the top panel swing to the maintenance position. (See *Preparations for maintenance* on page 33).

**CAUTION** If the top panel swing is not open, the top cannot be removed. An attempt to forcibly remove the top panel may damage the top panel swing or the top panel.

- 2 Loosen the screw for fastening the top panel.

- 3 Lift the top with the top panel swing at the right angle and remove it.

**CAUTION** Do NOT lift the top if the top panel swing is not at the right angle. Failure to follow this instruction may cause damage to the top panel swing and the top panel, or injury.

- 4 Remove the drain cap.

\*If it is difficult to open the drain trap cap, use the included drain trap tool. (See page 38.)

- 5 Remove the inner of drain trap, and then clean both drain trap and inside of drain trap.

- 6 Assemble the parts in the reverse order of removal.

**CAUTION** Take care not to get your fingers caught in the gap in fitting the top or closing the top panel swing. Failure to follow this instruction may cause injury.

Maintenance frequency

Once a year

## Maintain Of The Inside Of The Floor Unit

### Maintenance Of Drain

#### <How to use the drain trap tool>

Insert the drain trap tool into the drain trap cap, firmly hold both ends of the tool with both hands as shown in the figure, and slowly turn it counterclockwise.



**CAUTION**

Do not use the drain trap tool for occupying the drain trap cap.  
Failure to follow may cause damage to the drain trap cap.

Drain trap tool



Convex part of cap

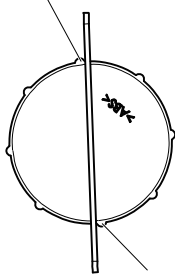

Convex part of cap

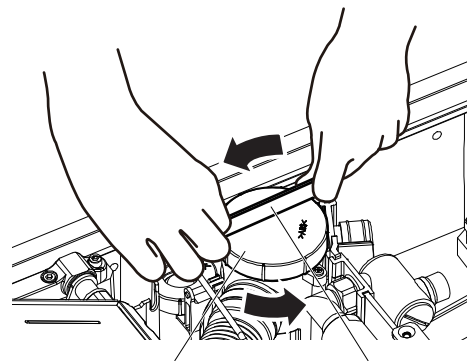

Cap

Drain trap tool

# Before Requesting Repairs

If the following problems arise, conduct the checks outlined before requesting repairs.

Symptom	Check this	Solution
<ul style="list-style-type: none"> <li>Hot water will not come</li> </ul>	→ Is the stop valve of the floor unit open?	Open the stop valves. (See page 24.)
	→ Is the connection pedal locked?	Put your hands on the basin and then depress the connection pedal. (See page 14.)
<ul style="list-style-type: none"> <li>When flow the hot water, sound.</li> </ul>	→ Does the sound stop when the bubble unit is removed and the faucet is turned on to provide warm water?	Clean the bubble unit. (See page 28.)
<ul style="list-style-type: none"> <li>Water is tepid.</li> </ul>	→ Is the water heater set to an appropriate temperature?	Set the water heater to the appropriate temperature.
	→ Is the temperature control handle set to an appropriate temperature?	Adjust the temperature control handle to an appropriate temperature. (See page 19.)
<ul style="list-style-type: none"> <li>Drainage condition is bad.</li> </ul>	→ Is there a buildup of hair and waste on the hair trap, drain trap, or drain coupler?	Remove hair clogged in the hair trap, drain trap, or drain coupler. (See pages 27, 30 to 32, and 35 to 38.)
<ul style="list-style-type: none"> <li>The upper and floor units cannot be connected (tough to connect)</li> </ul>	→ Is the release lever is pulled sufficiently?	Move the upper unit to the correct position and then step on the connection pedal.
	→ Are there scratches on the cold/hot water supply couplers?	Apply grease supplied to the cold/hot water supply couplers.
<ul style="list-style-type: none"> <li>The upper and lower units cannot be disconnected.</li> </ul>	→ Do you pull the connection release lever while depressing the connection pedal.	Adjust the wire of the release lever. (See page 42.)
<ul style="list-style-type: none"> <li>The top panel swing does not close.</li> </ul>	→ Does the connection release lever come out from the floor?	Pull the connection release lever up while depressing the connection pedal. If it still cannot be disconnected, adjust the wire of the release lever.(See page 42.)
	→ Is there a buildup of hair and waste around the top panel swing?	Clean the inside of the sump and the sash.
<ul style="list-style-type: none"> <li>Cannot open the top panel swing.</li> </ul>	→ Does the release lever work normally?	Remove the release lever part and move the lever pin using a screwdriver. (See page 41.)
<ul style="list-style-type: none"> <li>After stepping on the top panel swing, you hear the top panel swing sinking into water.</li> </ul>	→ Is water accumulated in the floor unit due to a water leak?	Periodically wipe drain water out from the sump. (See page 34.)
<ul style="list-style-type: none"> <li>Water overflows from between the Top panel swing and drain receptacle after depressing the top panel swing.</li> </ul>	→ Is water accumulated in the floor unit due to a water leak?	Periodically wipe drain water out from the sump. (See page 34.)
<ul style="list-style-type: none"> <li>Water drips from the upper unit.</li> </ul>	→ Is there a buildup of hair and waste in the drain coupler?	Clean the inside of the drain coupler. (See pages 30 and 32.)

If the product does not operate properly after checking and repairing the above points, stop using the product immediately.

## Consumables

The following parts are "consumable supplies" and wear, degradation, changes in external appearance and damage are expected.

Please note that repair or replacement of these parts is not covered by warranty, and a fee will be required.

(\* The level and period of wear, degradation or damage may differ depending on the environment and conditions that the customer uses this product in)

Inspections or replacement of parts will be required if there is extensive wear, degradation or damage.

Consumable supplies (the following parts are not covered by warranty, and a fee will be required)

- Spa shower head foaming water part (foaming water outlet, packing)
- Lubricant (oil, grease, etc) • Neck cushion • Hair trap • Whirligig of stop vale • Shower hose
- Head pillow • Release lever cap • O-ring • Various types of packing • Drain cap
- Drain Stopper Rubber • AABattery • Down leak prevention cloth

External scratches or dirt, degradation or fading of the following external parts are not covered by warranty.

- Covers, frames, basin • Handles (Faucet Handle / temperature-control handles)
- Others (including the shower head) • Castor • Floor panel

## Standard Duration Of Use

The standard period of use of this product is seven years.

The standard period of use is "a guide for the standard period that this product can be used properly from a safety perspective, when conducting appropriate maintenance and inspections (including replacement of parts) for the standard usage conditions for each product.

This is not the same as the warranty period.

## Disposing Of Product

When disposing of this product or replaced parts, adhere with current regulations and dispose of them appropriately.

## After-sales Service

To request after-sales service, contact your closest dealer or TAKARA BELMONT directly.



# Emergency Response

## ■ When The Top Panel Swing Does Not Open

Remove the release lever part attached to the top and directly handle the part that locks the top panel swing release the lock.

1. Remove the two screws near the release lever.

※ Take care not to lose the screws you removed.

Tools for use: No. 2 Phillips screwdriver

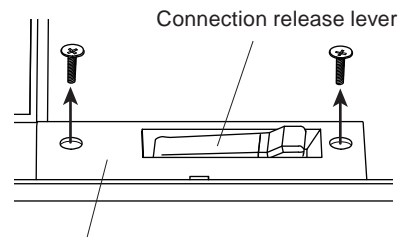

2. Insert a flat head screwdriver into the notch near the release lever and, while lifting the area around the release lever applying the principle of leverage, remove the release lever part.

Tools for use: No. 2 Phillips screwdriver

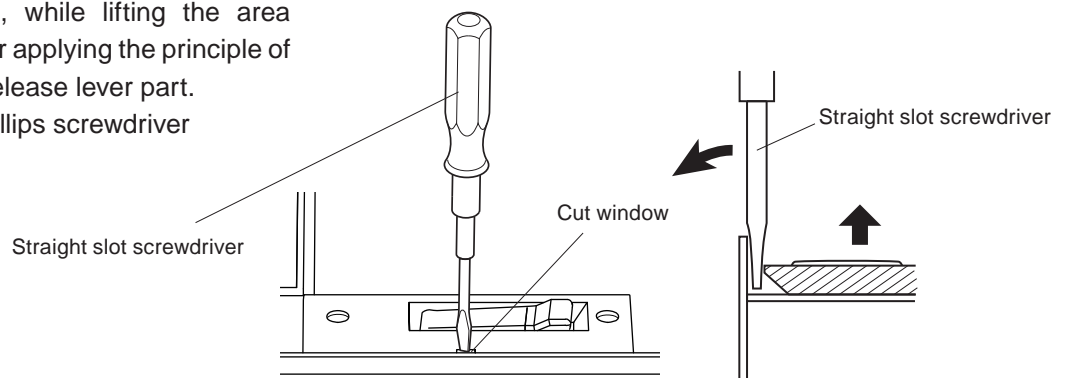

3. There is a lever pin inside.

Move the screwdriver as shown in the figure below to move the lever pin.

The lock is released.

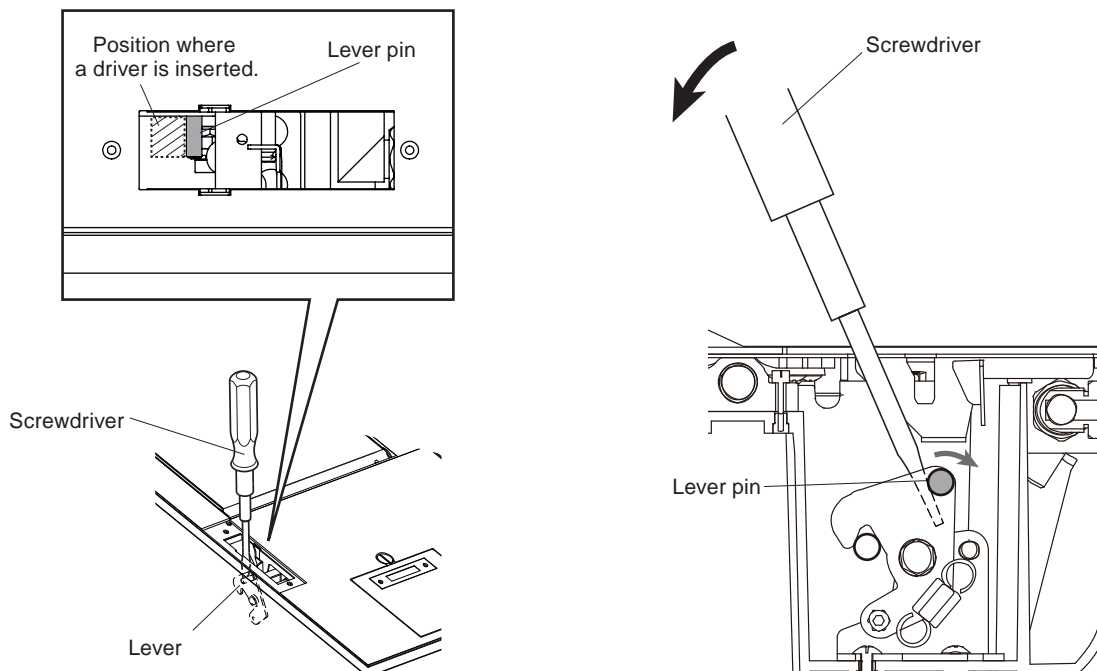

When the lock is released in the way mentioned above, return the release lever part to the original position before use.

## ■ When The Upper And Floor Units Cannot Be Disconnected

Adjust the wire of the release lever according to the following procedure.

1. Insert a Phillips screwdriver into the hole under the release lever.

Tools for use: No. 2 Phillips screwdriver

2. Turn the Phillips screwdriver you inserted as shown in the figure below to tighten the screw.

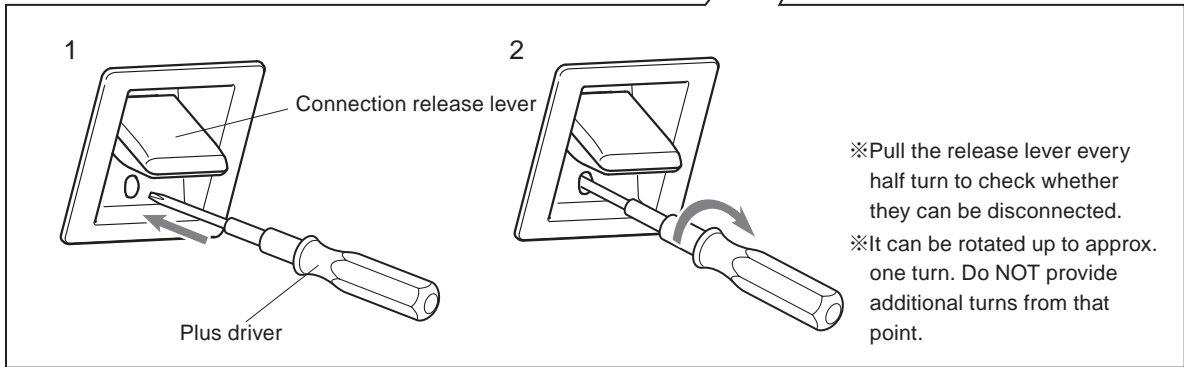
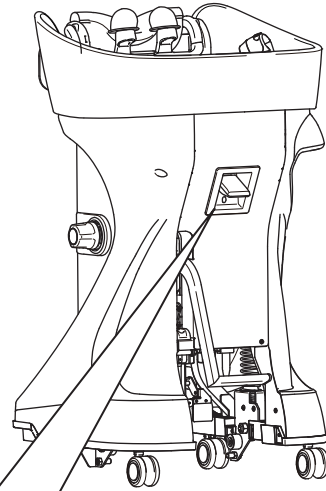

**CAUTION**  If they cannot be disconnected according to the procedure mentioned above, follow the procedure below to disconnect them with an emergency.

1. Securely hold the connection pedal by hand.
2. Insert a thin rod like a screwdriver into the gap over the release bar and lift in the direction indicated by the arrow.  
Tools for use: No. 2 Phillips screwdriver
3. The release bar is moved down by the principle of leverage and they are disconnected.

※ During the emergency release operation, securely hold the connection pedal by hand. Failure to follow this instruction may cause the connection pedal to jump at the time of release, causing injury.

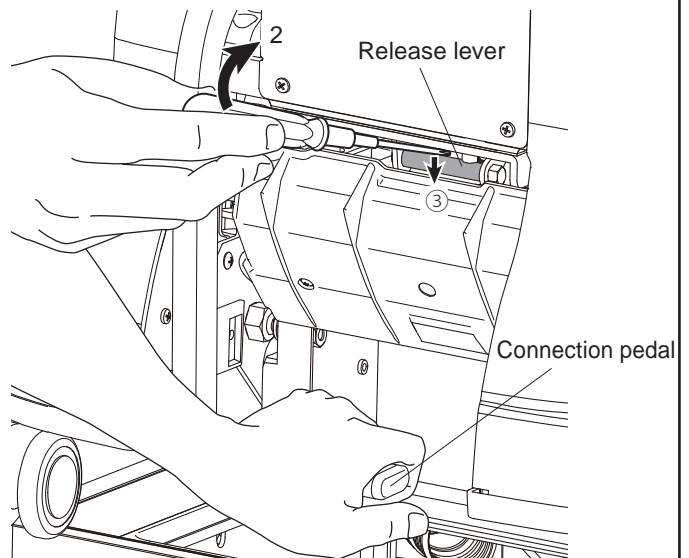

# Specifications

Model No.	EX-OAYMYM-*	EX-OAYMSS-*
Faucet fittings	Thermo mixing system	Thermo mixing system
Outlet	Switching system (aerator/shower)	Switching system (aerator/shower)
Outlet flow rate (Hot water supply pressure, water supply pressure: 0.1 MPa each)	Aerator : Approximately 7.5 L/min Shower : Approximately 8.5 L/min	Aerator : Approximately 8.0 L/min Shower : Approximately 9.5 L/min
Faucet system	Single faucet (handle type)	Single faucet (handle type)
Mass	Upper unit 48 kg Floor unit 16 kg	Upper unit 46 kg Floor unit 16 kg
Operating condition	10 °C to 40 °C	10 °C to 40 °C

## External View Drawing

- Upper unit/floor unit combination

<Back Wash Basin (YUME Basin) >

Model No. EX-OAYMYM-\*

<Side Wash Basin>

Model No. EX-OAYMSS-\*

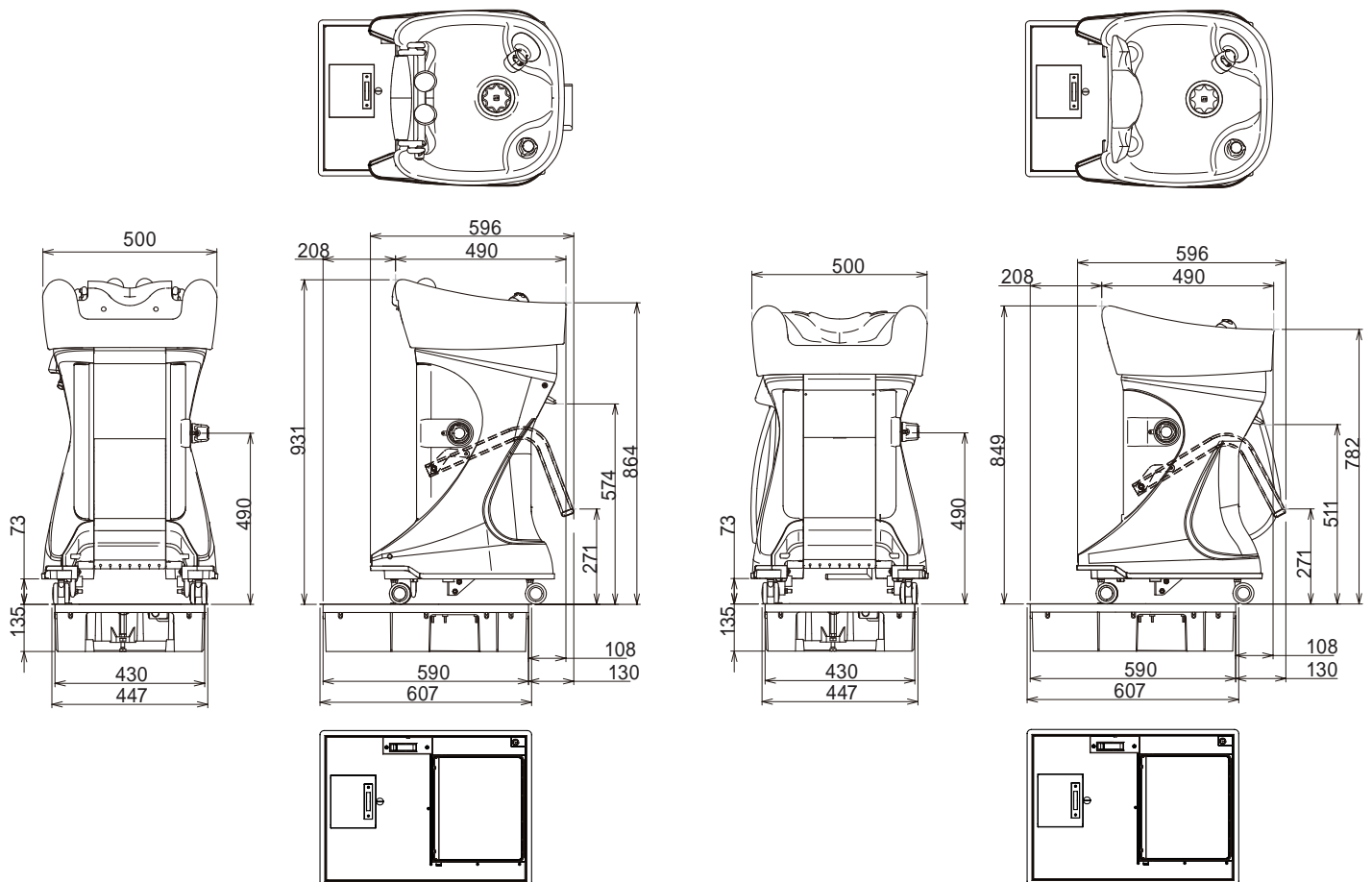

The "\*" part of the individual product numbers shown above depends on the product color.

# Daily Check Guide

To ensure that this product can be used for a long period of time, conduct the inspections below.

## ■ Daily Check Items

Check item	How to check	If rejected as a result of checks
<input type="checkbox"/> Does the plating of the temperature control /faucet handle come off?	<input type="checkbox"/> Visually check the appearance of the temperature control /faucet handles for flaws, cracks, or separation of plating on the plated surfaced surface.  <input type="checkbox"/> During operation or maintenance, check whether there is any stuck or a feeling of strangeness.	<input type="checkbox"/> Flaws, cracks, or separation of the plating may cause hand injuries.
<input type="checkbox"/> Does the neck cushion deteriorate?	<input type="checkbox"/> Check the surface of the neck cushion for a tear, dirt, or deterioration.	<input type="checkbox"/> It may hurt the customer's head or make it dirty. The neck cushion is a consumable. Immediately replace it. (See pages 11 to 12.)
<input type="checkbox"/> Is there an unusual smell from the drain port of the basin?	<input type="checkbox"/> Check whether there is an unusual smell from the drain port of the basin.	<input type="checkbox"/> Remove a buildup of hair etc. if it appears in the hair trap. (See page 27.)
<input type="checkbox"/> Does water come out from the shower head properly?	<input type="checkbox"/> Turn on the faucet to provide hot/cold water, visually check whether water comes out from the shower head properly.	<input type="checkbox"/> If the hot/cold water does not come out properly, clean the shower head. (see Page 28)
<input type="checkbox"/> Does water leak from the bottom of the shower-head	<input type="checkbox"/> Visually check the bottom of the shower head.	<input type="checkbox"/> If water leaks from the bottom even after the shower head and the hoses are re-tightened, the packing materials inside may deteriorate.
<input type="checkbox"/> Does the temperature control handle work normally?	<input type="checkbox"/> Turn the handle and check whether the temperature is controlled properly and whether there is an unusual noise.	<input type="checkbox"/> In such a case where the temperature is not controlled properly or there is an unusual noise, the thermal parts may be defective.
<input type="checkbox"/> Can water be stored?	<input type="checkbox"/> Close the drain port with the trap cap and store water, and then check whether water drains.	<input type="checkbox"/> If the stored water drains fast, the packing of the trap cap may deteriorate.
<input type="checkbox"/> Are the upper and floor units connected properly? Is the connection tight?	<input type="checkbox"/> Step on the connection pedal until you hear it click.	<input type="checkbox"/> Pull up the release lever to disconnect the upper unit, and connect it again. (See page 14 and 16.) In addition, clean the cold/hot water supply couplers and apply grease supplied to them. (See page 34.)

## ■ Daily Check Items

Check item	How to check	If rejected as a result of checks
<input type="checkbox"/> They are disconnected normally by pulling up the release lever?	<input type="checkbox"/> Pull up the release lever and check that the connection pedal automatically returns to the original position.	<input type="checkbox"/> If they are not disconnected even after the release lever is pulled up, adjust the wire of the release lever.
<input type="checkbox"/> Does the alarm of the prevention tilt mechanism sound properly?	<input type="checkbox"/> When the bowl is tilted, does an alarm with a high-pitched tone sound?	<input type="checkbox"/> If the alarm sounds at an intermittent high-pitched tone, or does not sound, the cells reach the end of their lives. Replace the cells. (See page 23.) If an alarm with a high-pitched tone does not sound even after the cells are replaced,..
<input type="checkbox"/> Is water accumulated in the lower unit?	<input type="checkbox"/> Open top panel swing and visually check the drain hose for a water leak.	<input type="checkbox"/> Immediately stop using.

## ■ What to be checked always after the close of business

Check item	How to check	If rejected as a result of checks
<input type="checkbox"/> Does water stop?	<input type="checkbox"/> Open top panel swing and check the cold/hot water supply couplers for water drips.  <input type="checkbox"/> Open top panel swing and check whether water is stored inside.	<input type="checkbox"/> If water does not stop, the couplers may be defective. Close the faucets of the cold/hot water supply pipes (see Page 24).  <input type="checkbox"/> If water leaks from the drainpipe, the pipe or the packing may be worn/deteriorated or damaged. Immediately stop using.  ※ In this product, water tends to accumulate in the lower unit due to condensation in the underfloor environment or a spray of water caused during connection/disconnection. If it is left as it is, the floor and the underfloor area may be made dirty. So periodically wipe off water. (See page 34.)

## ■ Weekly check items

Check item	How to check	If rejected as a result of checks
<input type="checkbox"/> Does water leak from the drain flexible hose?	<input type="checkbox"/> Remove the maintenance lid of the lower unit and check the drain flexible hose for a water leak.	<input type="checkbox"/> If water leaks from the drain flexible hose, the drain flexible hose may be damaged. Immediately stop using.
<input type="checkbox"/> Is there a buildup of water scale and dirt on the water spray plate of the shower head?	<input type="checkbox"/> Remove the water spray plate of the shower head and check it for dirt, such as water scale.	<input type="checkbox"/> Remove dirt, such as water scale, using a toothbrush etc. and clean it. If it is left as is, clogging occurs and water in the shower mode may not come out normally. (See page 28.)









TAKARA BELMONT CORPORATION  
1-1, 2-Chome, Higashi-shinsaibashi, Chuo-ku, Osaka, Japan  
TEL : (06) 6213-5945 FAX : (06) 6212-3680

Printed in Japan

Book Number 

1E05LLA0
----------