

# YUME NAGOMI

## QUICK OPERATION GUIDE

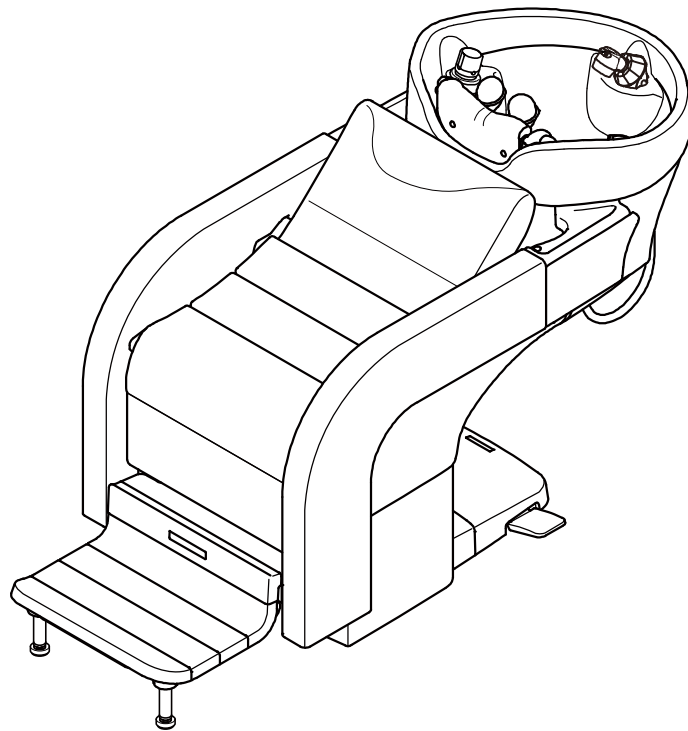



For details and safety information  
see the operating instructions.

<https://beauty.takarabelmont.co.jp/manual-site/>



# 1 Footrest/Reclining Pedal

## Footrest

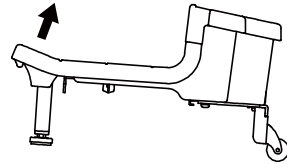
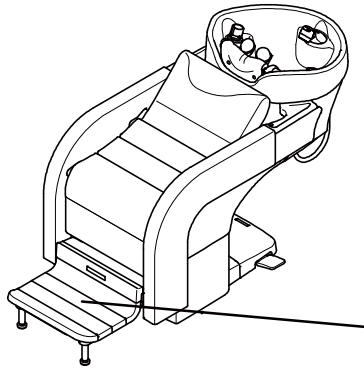

Lift up slightly when sliding the footrest

## Reclining Pedal

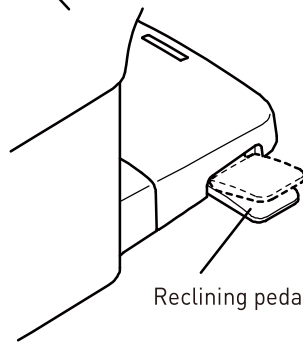
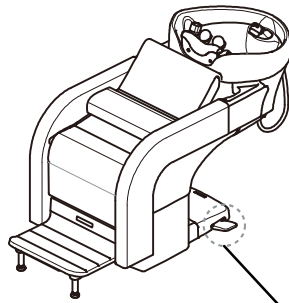

Reclining pedal

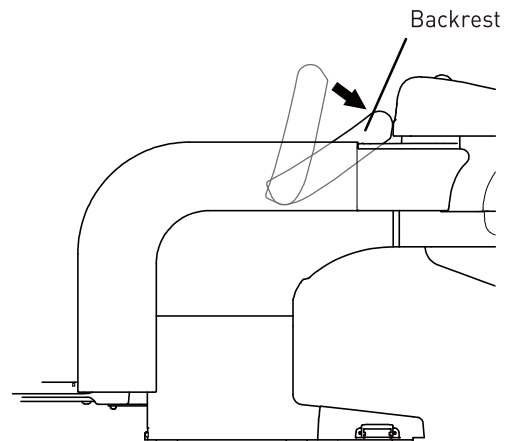

Backrest

### Shampoo Basin

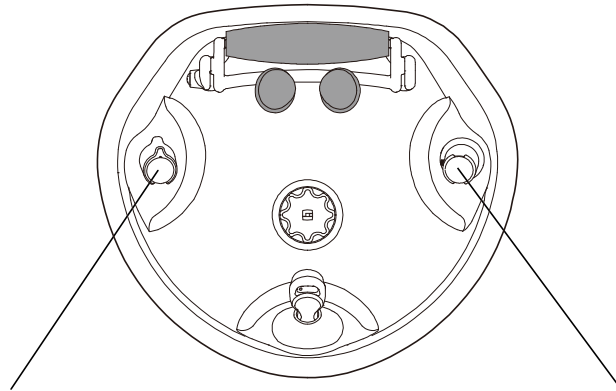

Tap

Thermostatic Control

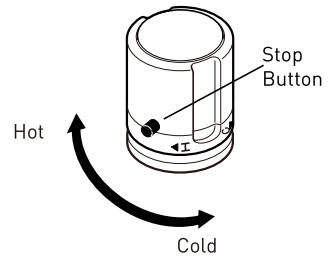
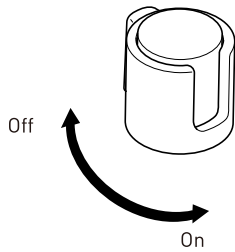

To adjust the temperature over 40 degrees, turn the knob while pressing the Stop Button

Drain Cap (Old)

Drain Cap (New)

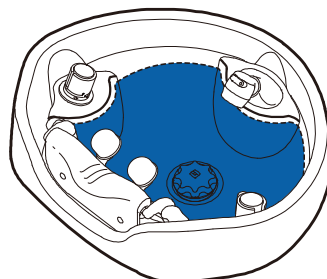
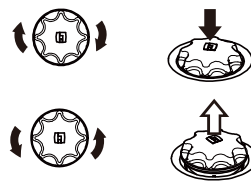

### Dual Function Shower Head

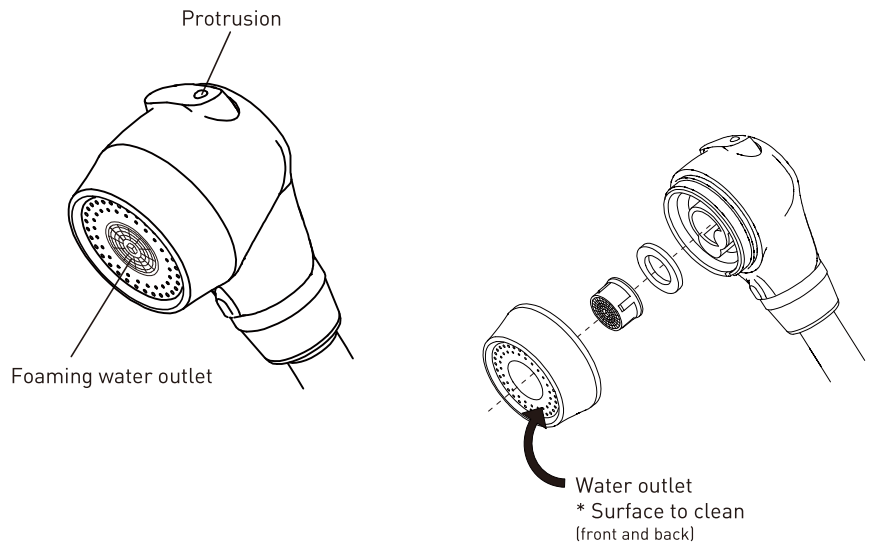

### Shower Mode

<Shower Mode>



<Low Splash Foaming Mode>

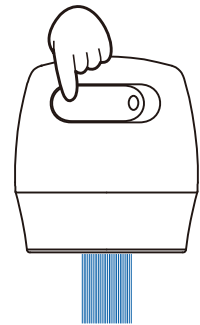

### Shower Head Holder

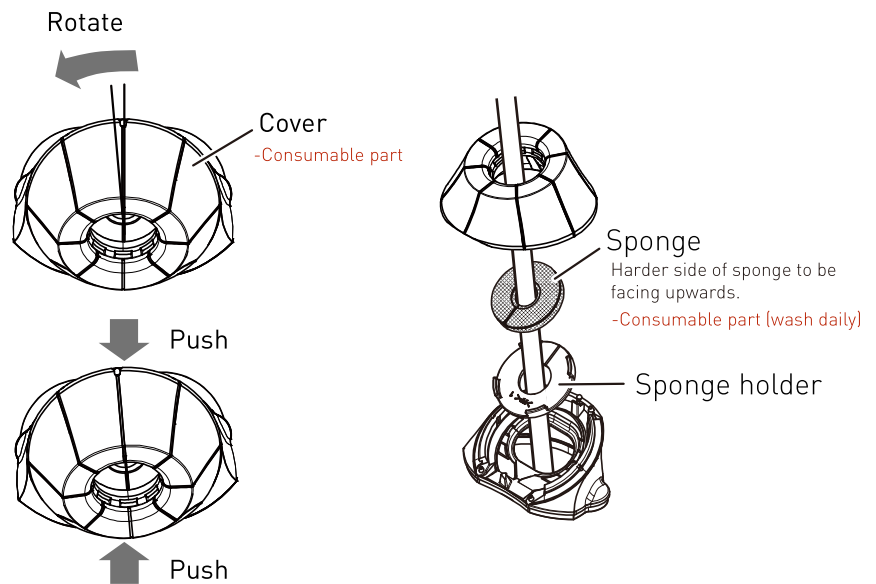

### Neckrest Device (when rinsing perm lotion)

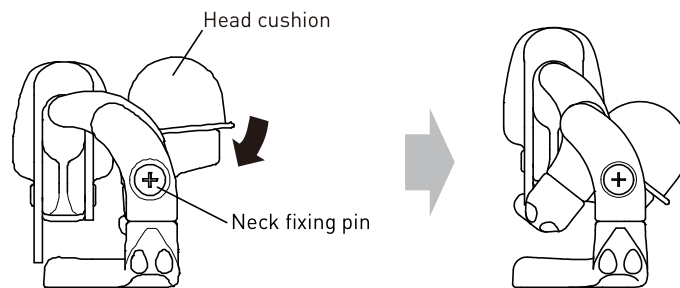

1 Rotate the head cushion as shown above

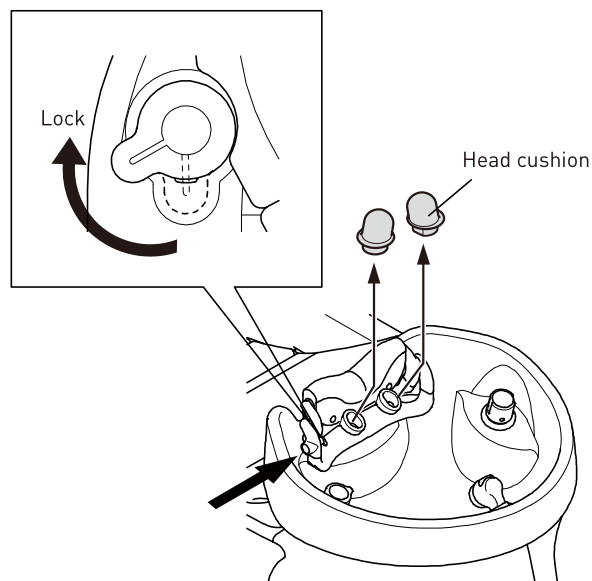

2 Lock and remove the head cushion when rinsing

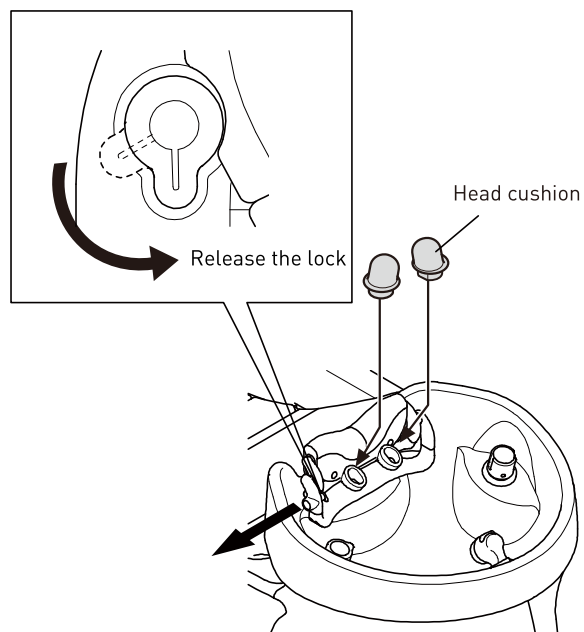

3 Release the lock and attach the head cushion back after rinsing

1 Attach the Neck Cushion and Head Pillow.

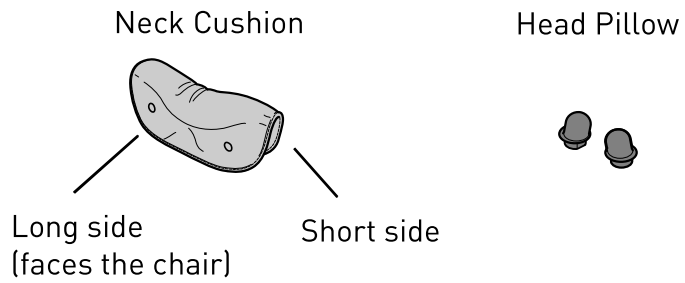

2 Attach both sides of the Neck Cushion with snap button.

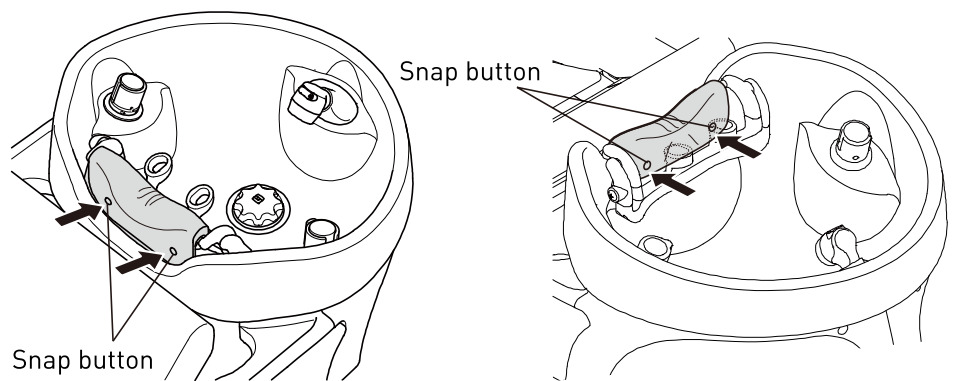

3 Attach the head pillow as shown below.

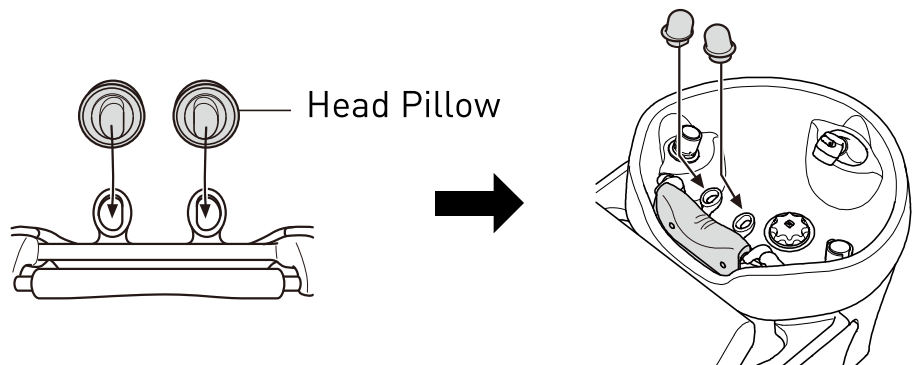



- 1 Use the reclining pedal to bring the chair to its initial position

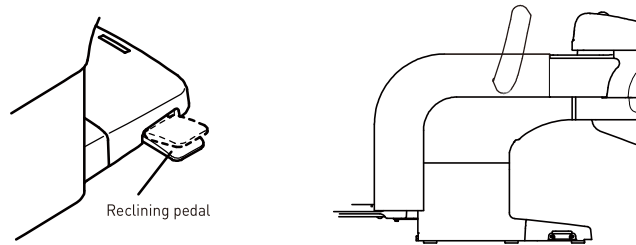

- 2 Slide out the footrest if necessary

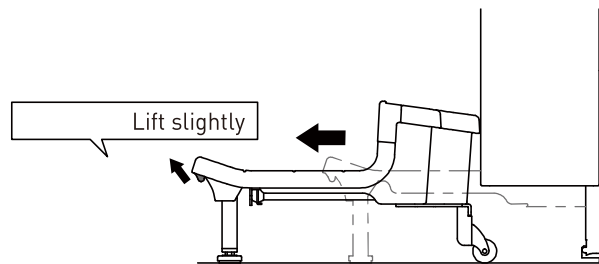

- 3 Instruct the customer to sit

- 4 When reclining the chair, follow the instructions below

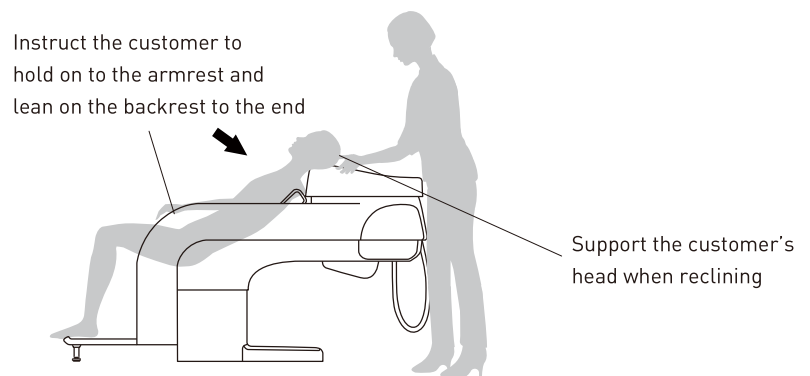

5 Adjust the angle

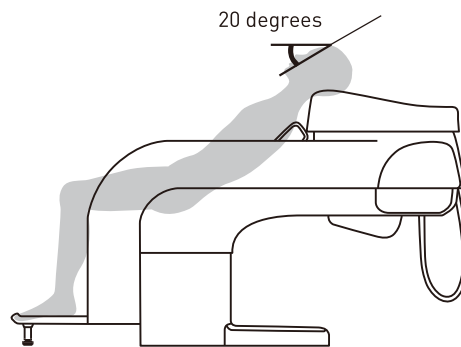

 **CAUTION**

Do not operate the reclining pedal sitting down. Always make sure there are no obstacles in the way of the backrest.



<Shampooing Style>

(Seated)

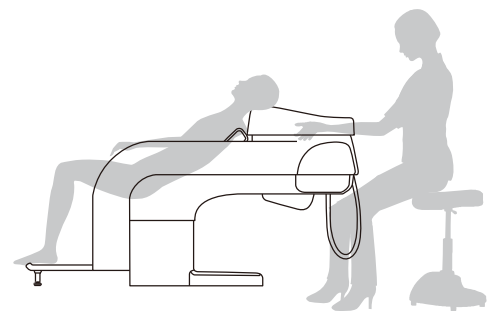

(Standing)

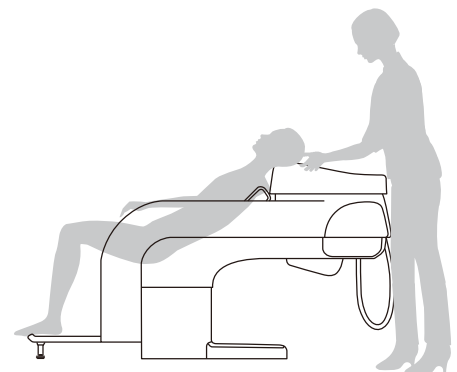

- 6 After the shampooing is done, return the chair to its initial position (support the customer's head)

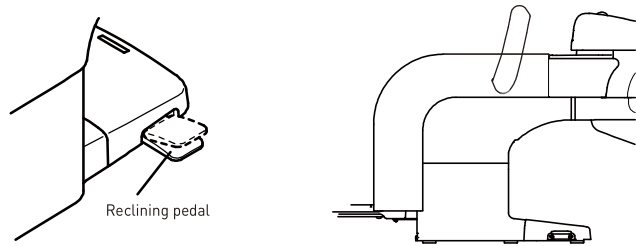

- 7 Wipe off the remaining water after use

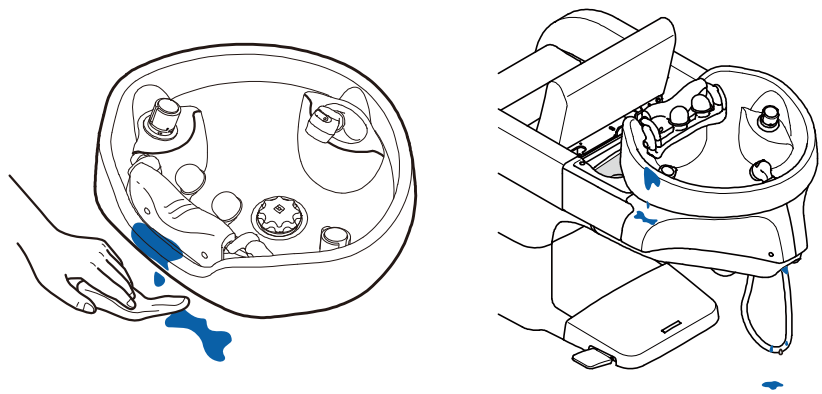

- 8 Clean the consumable parts

Neck Cushion

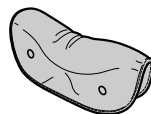

Head Pillow



Drain Cap

<Old>

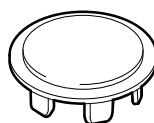

<New>



Hair Catcher

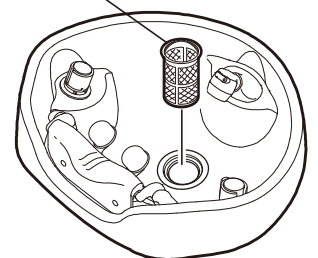



**TAKARA BELMONT CORPORATION**

2-1-1, Higashishinsaibashi, Chuo-ku, Osaka, 542-0083, Japan

TEL : 81-6-6213-5945

FAX : 81-6-6212-3680

