

SPA MIST II

GUIDA RAPIDA AL FUNZIONAMENTO

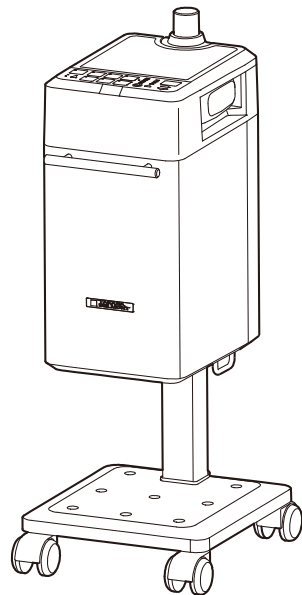

Per i dettagli e le informazioni sulla sicurezza,
vedere le istruzioni operative.

<https://beauty.takarabelmont.co.jp/manual-site/>



1 Pannello di controllo

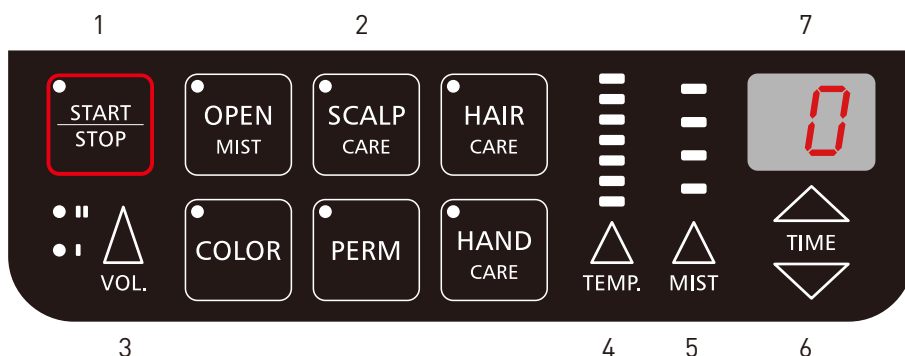

1 Tasto Avvio/Arresto



2 Tasto di selezione modalità



Shampoo / massaggio con agente chimico



Agente per permanenti di tipo riscaldato / agente di arricciatura



Tinta per capelli acida
*Tempo di raffreddamento: 5 min



Trattamento / Agente per permanenti di tipo riscaldato / agente di arricciatura



Agente di pulizia cuoio capelluto
Trattamento cuoio capelluto



Cosmetico per la cura delle mani

3 Tasto Volume



Muto



Livello 1



Livello 2

4 Tasto Livello temperatura

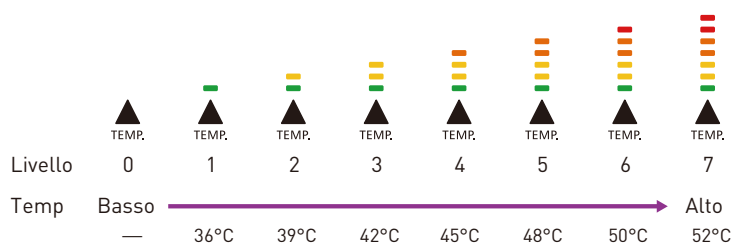

5 Tasto Livello nebbia

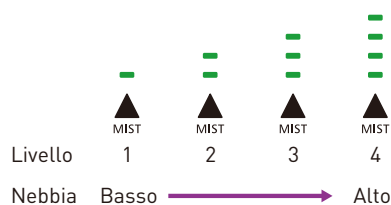

6 Tasto di impostazione tempo



7 Pannello di visualizzazione

Indicazione di stato



Indicazione del tempo



Raffreddamento e tempo rimanente



Mancanza di acqua nel flacone di erogazione acqua. Riempire di nuovo con acqua distillata



Troppa acqua nella macchina



Preriscaldamento

Indicazione di errore



Errore unità di rilevamento temperatura
Errore riscaldatore



Errore unità rilevamento temperatura



Errore unità rilevamento livello acqua
Errore interruttore galleggiante

2 Preparazione

- 1 Fissare il giunto della cuffia N sulla cuffia nebbia (opzione).

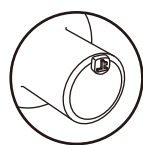
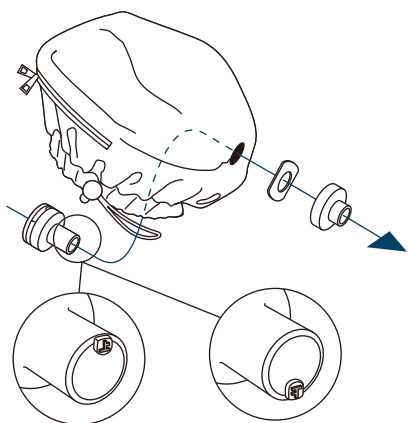

- YUME e ugello a sfera nebbia aperto
- Shampoo posteriore e YUME
- Poltrona per messa in piega

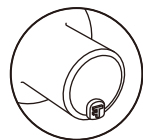

- CALME e poltrona da uomo

- 2 Versare acqua distillata nel flacone di erogazione acqua.

1. Rimuovere il tappo dal flacone di erogazione acqua e versare acqua distillata.

 **ATTENZIONE**

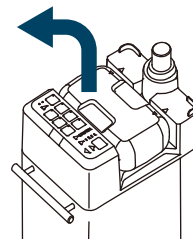

2. Chiudere il tappo del flacone di erogazione acqua.

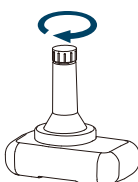

3. Svuotare il serbatoio di scarico e assicurarsi che il rubinetto di scarico sia stato chiuso.

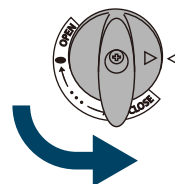
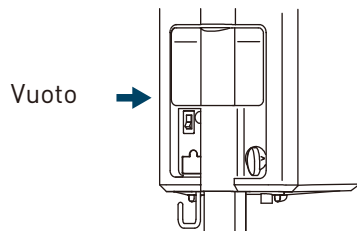

4. Inserire il flacone di erogazione acqua nella parte superiore dell'unità.

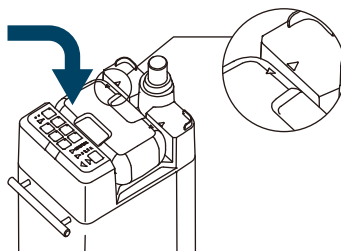

3 Procedure operative

1 Inserire il tubo flessibile nell'ugello di scarico.

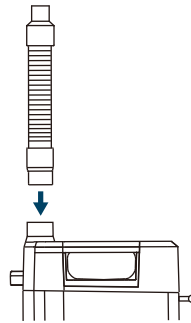
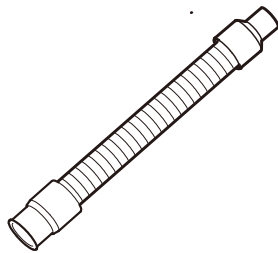

2 Impostare l'unità principale dietro il cliente.

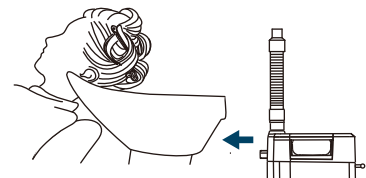
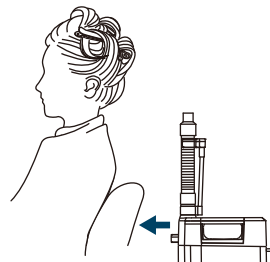

3 Collegare e accendere l'alimentazione.



4 Premere il tasto relativo alla modalità desiderata.



Shampoo/massaggio con agenti chimici
*NON utilizzare la cuffia nebbia.



Agente per permanente di tipo riscaldato/agente di arricciatura
*È possibile utilizzare una cuffia nebbia opzionale.



Tinta per capelli
*Tempo di raffreddamento: 5 min
*È possibile utilizzare una cuffia nebbia opzionale.



Trattamento
*Tempo di raffreddamento: 2 min
*È possibile utilizzare una cuffia nebbia opzionale.



Agente di pulizia per il cuoio capelluto
Trattamento per il cuoio capelluto
*È possibile utilizzare una cuffia nebbia opzionale.



Cosmetico per la cura delle mani
*Può essere utilizzata una copertura opzionale.

5 Premere il tasto di avvio/arresto per implementare il preriscaldamento.



3 Procedure operative

Applicare la cuffia nebbia e inserire il tubo flessibile nel giunto della cuffia N.

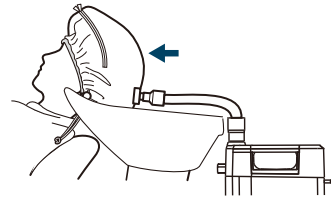
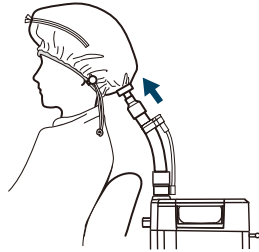
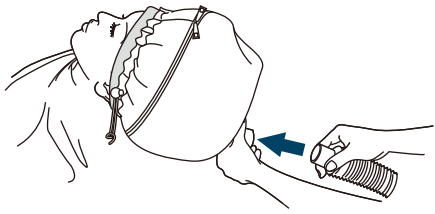

6 Premere il tasto di avvio/arresto per avviare il funzionamento.



7 Durante il funzionamento.

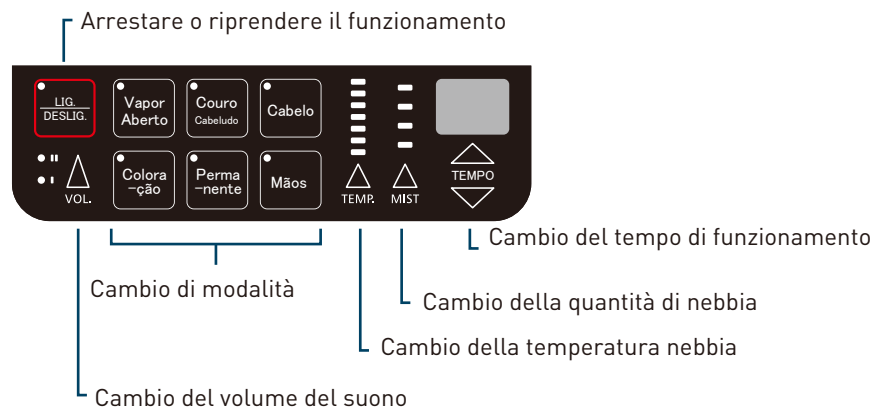

8 Raffreddamento.



9 Tempo scaduto.



- 10 Spegnere l'alimentazione al termine del lavoro.



- 11 Eliminare l'acqua accumulata nel serbatoio di scarico.

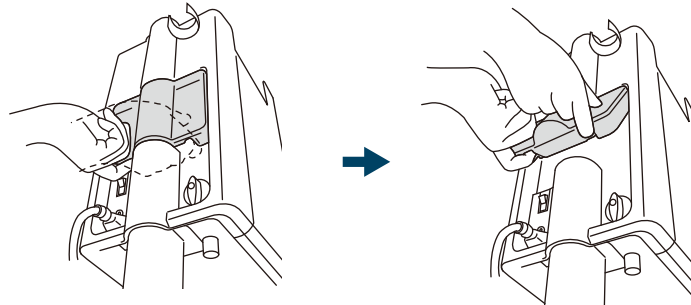

- 12 Svuotare il serbatoio dell'acqua dopo l'uso.

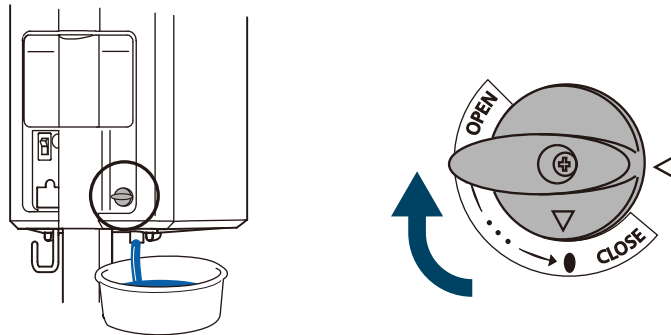

- 13 Sistemazione del tubo flessibile.

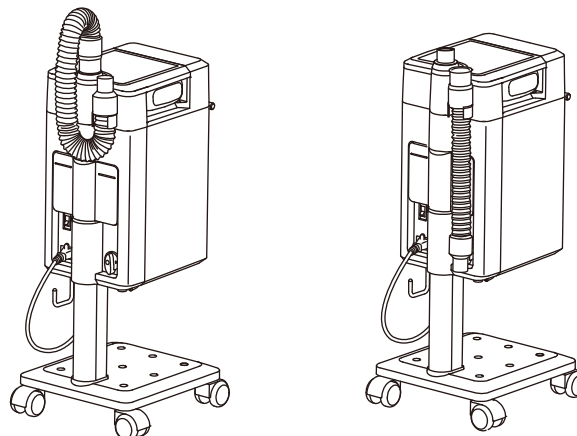

4 Inserimento / rimozione della cuffia nebbia

1 Quando si utilizza una posizione di lavaggio posteriore.

Posizionamento della cuffia nebbia

1

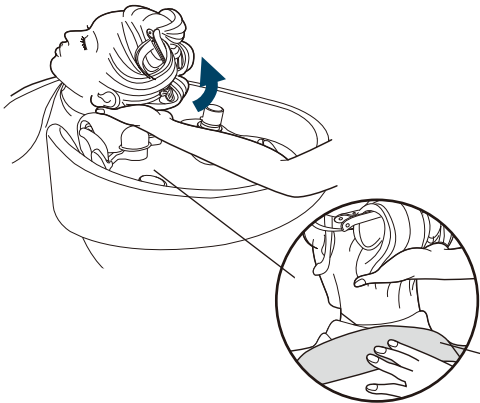

Fascia per la testa

2

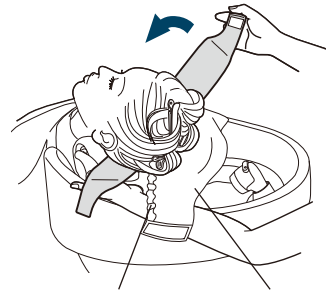

Protezione in gomma

Cuffia nebbia

3

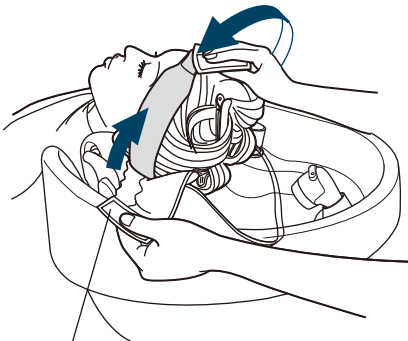

Fissaggio a strappo

4

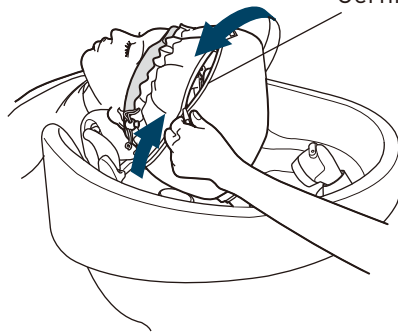

Cerniera

5

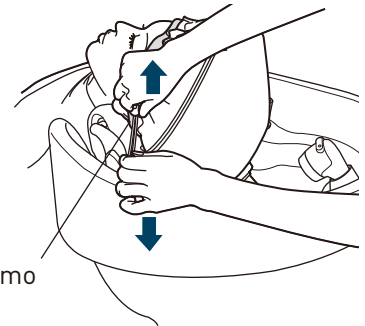

Fermo

6

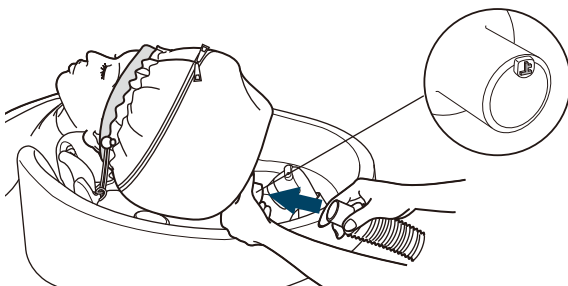

7

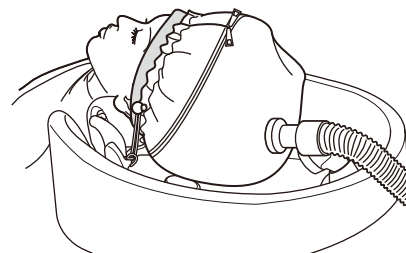

Rimozione della cuffia nebbia

1

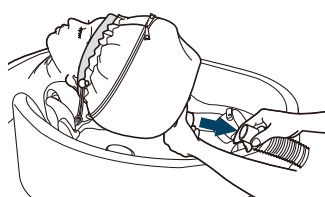

2

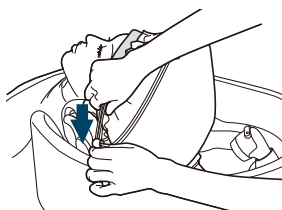

3

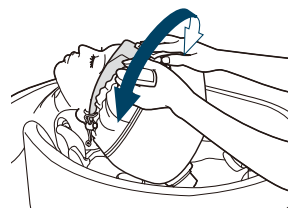

4

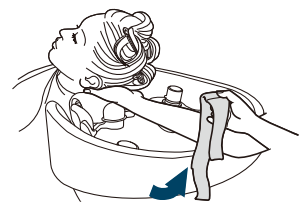

Video

4 Inserimento / rimozione della cuffia nebbia

2 Quando si utilizza nella postazione di messa in piega.

Posizionamento della cuffia nebbia

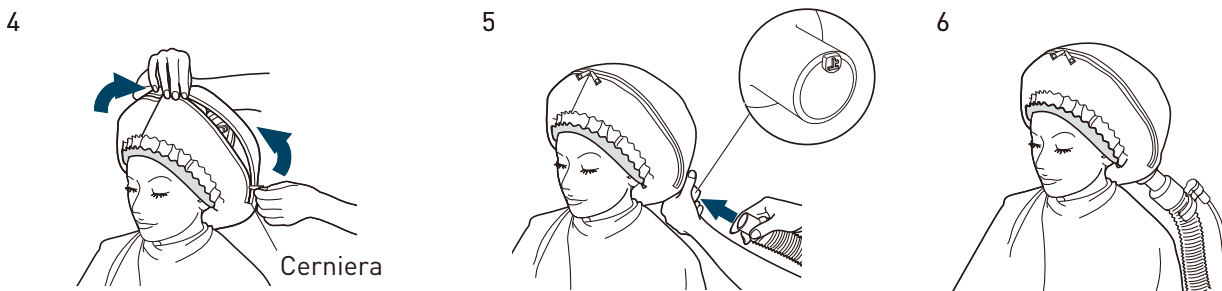
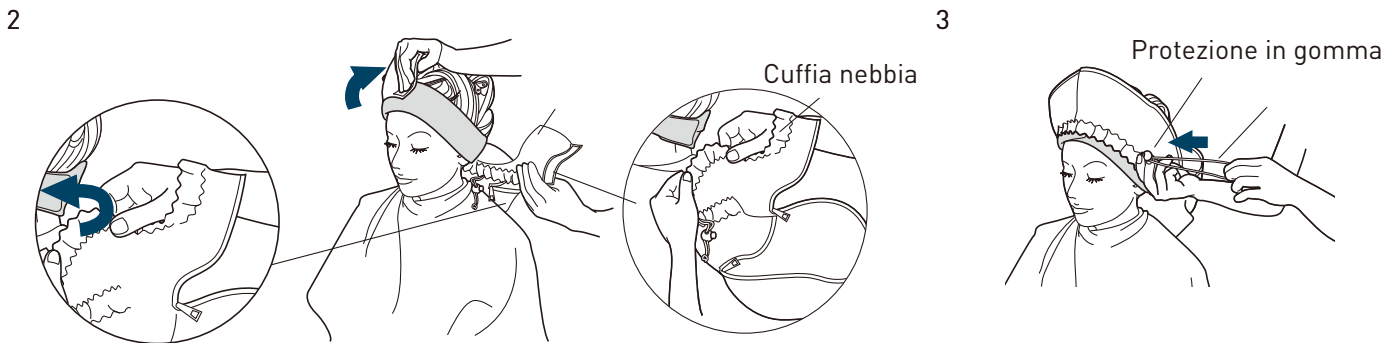
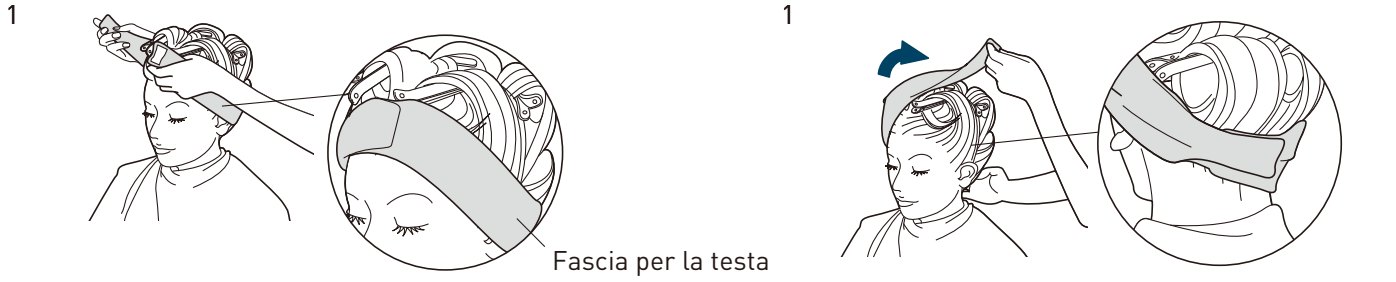

Rimozione della cuffia nebbia

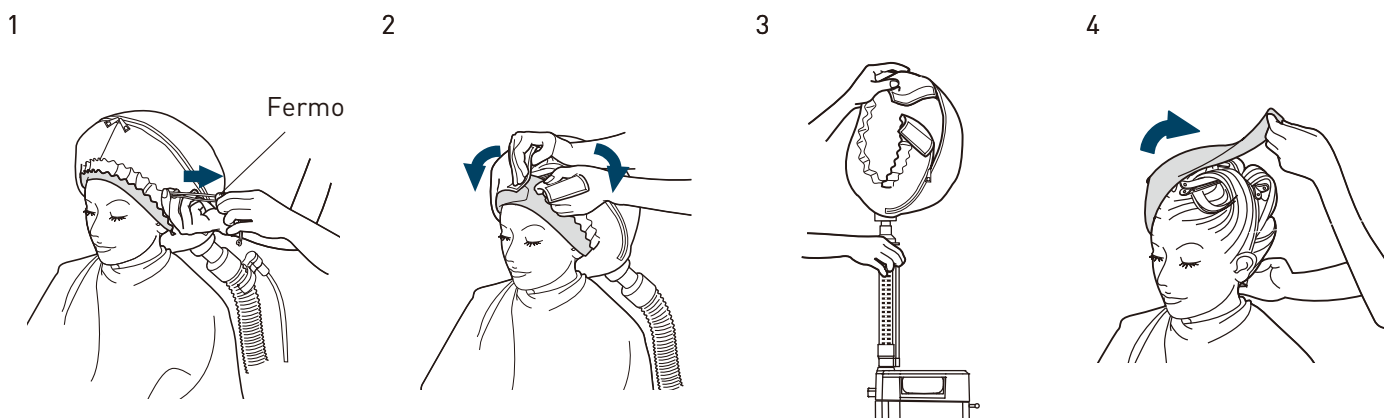

Video



TAKARA COMPANY EUROPE GmbH

Berner Strasse 18, 60437

Frankfurt am Main, Germany

TEL : +49-69-506878-0

FAX : +49-69-506878-20



TAKARA BELMONT CORPORATION

2-1-1, Higashishinsaibashi, Chuo-ku, Osaka, 542-0083, Japan

TEL : 81-6-6213-5945

FAX : 81-6-6212-3680

