

YUME DX

Operating Instructions

Translation of the original instructions



Thank you for purchasing our Takara Belmont YUME DX.

The instructions contained in this booklet should be thoroughly -read and understood before operating the shampoo unit.

This product is intended for the exclusive use for hairdressing & barber salons, and must not be used for other purpose.

Keep manual in a place where it can be easily referred to when necessary.

 **TAKARA
BELMONT**

1A0FTXA0

Version 12

2023.12

TABLE OF CONTENTS

1. Description of Warning Symbols	1
2. Locations of Warning Labels	2
3. Dimension and Specifications	3
4. Overall View and Major Components	4
5. Accessories	6
6. Preparation	6
7. Operating Instruction	8
8. Maintenance	12
9. Troubleshooting	15
10. Parts Replaced on a Regular Basis	16
11. Consumable Supplies	16

1. Description of Warning Symbols

■ Before using this product



The "Safety Precautions", "Precautions for Use" and "Precautions for Handling Synthetic Leather" contained in this booklet should be thoroughly read and understood before use.

■ Precautions listed here



The precautions listed here are to ensure that this product can be used safely, and to prevent any danger or risk to the person using this product or those around them.

These precautions are important for ensuring safety. Adhere to these precautions at all times. Takara Belmont is not responsible for any damage or risk to the person using this product or those around them due to accidents if this product is used without adhering to the "Safety Precautions", "Precautions for Use" and "Precautions for Handling Synthetic Leather". In this case, the person failing to adhere to the "Safety Precautions", "Precautions for Use" and "Precautions for Handling Synthetic Leather" will be responsible for any damage or risk incurred.

Detailed descriptions of symbols are provided below. Read and understand these symbols thoroughly before reading this instruction.

Classification	Level and urgency of harm or damage
 Warning	If this symbol is ignored and the product is used, "there is the risk of death or serious injury to the user".
 Caution	If this symbol is ignored and the product is used, "there is the risk of light or moderate injury or physical damage".

The specific points that are to be abided by are explained using the following symbols.

Symbols of prohibited matter	Symbols of guidance or instruction
 Common prohibited actions	 Guidance or instruction regarding common user actions  MANUFACTURER

2. Locations of Warning Labels

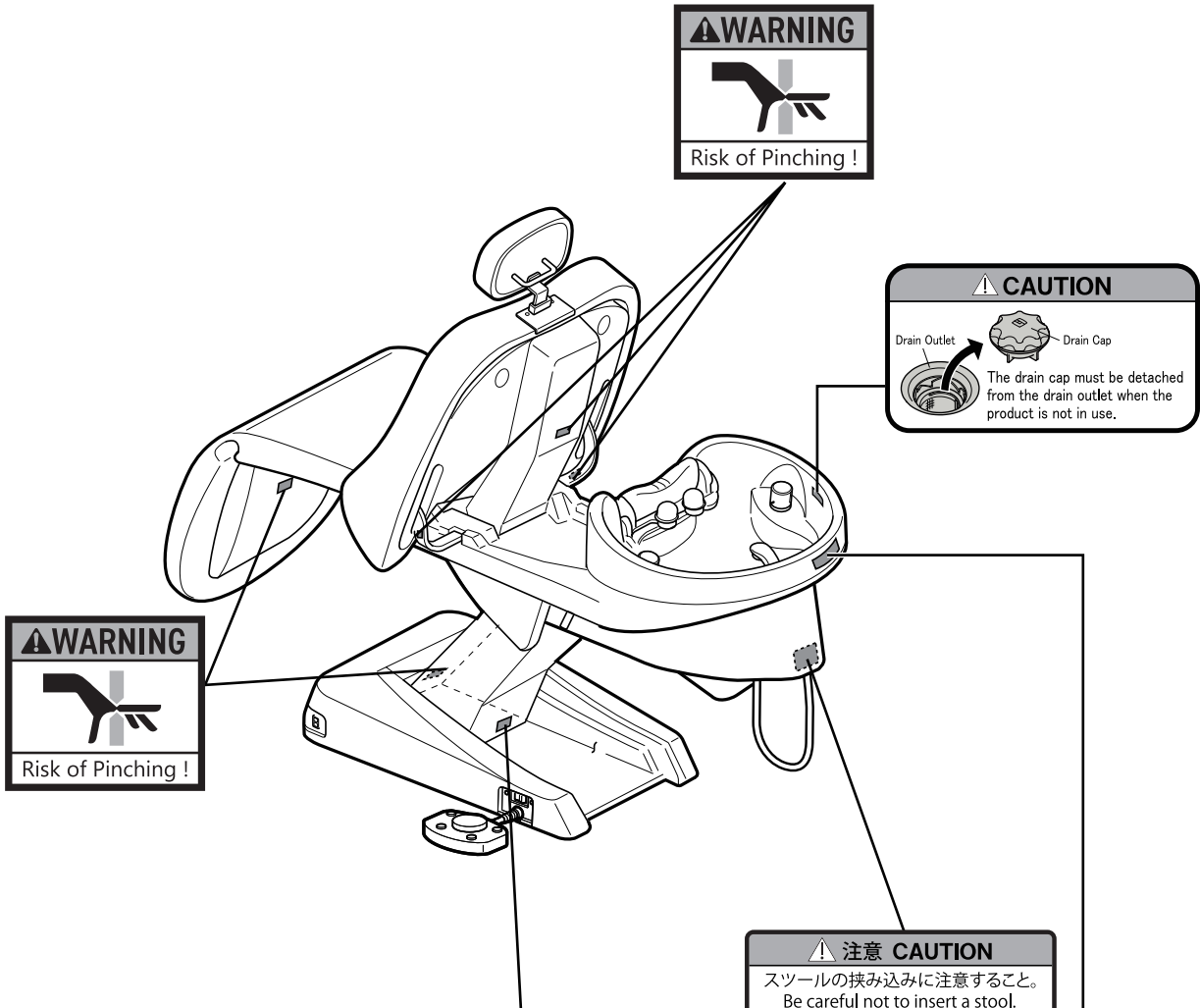

⚠ WARNING

 Risk of Pinching !

⚠ WARNING

 Risk of Pinching !

⚠ CAUTION

 The drain cap must be detached from the drain outlet when the product is not in use.

⚠ 注意 CAUTION
 スツールの挟み込みに注意すること。
 Be careful not to insert a stool.

⚠ WARNING Risk of Pinching KEEP OFF hands or obstacles when adjusting angle.	⚠ WARNING Risk of Electric Leakage. DO NOT drench the unit.	⚠ WARNING Disconnect power supply plug when unit is not in use.	⚠ WARNING Risk of Electric Shock and malfunction. DO NOT disassemble, repair or modify.
---	---	---	---

Please read the Operating Manual carefully for other safety cautions.

⚠ CAUTION Do not use hot water of 60°C and higher. Using hot water at 60°C and higher may deform or damage the ceramic bowl, the shower head or the faucet handle.	⚠ CAUTION If chemical such as hair dye attached to the equipment, wipe it out immediately, or it may cause discoloration or deterioration.	⚠ CAUTION Do not use chemical detergent mainly containing caustic soda (NaOH) & caustic potash (KOH) for cleaning drain pipes, etc. This may cause damage on the drain hose, etc.
--	--	---

For other cautions, please read the operating instruction carefully before use.

3. Dimension and Specifications

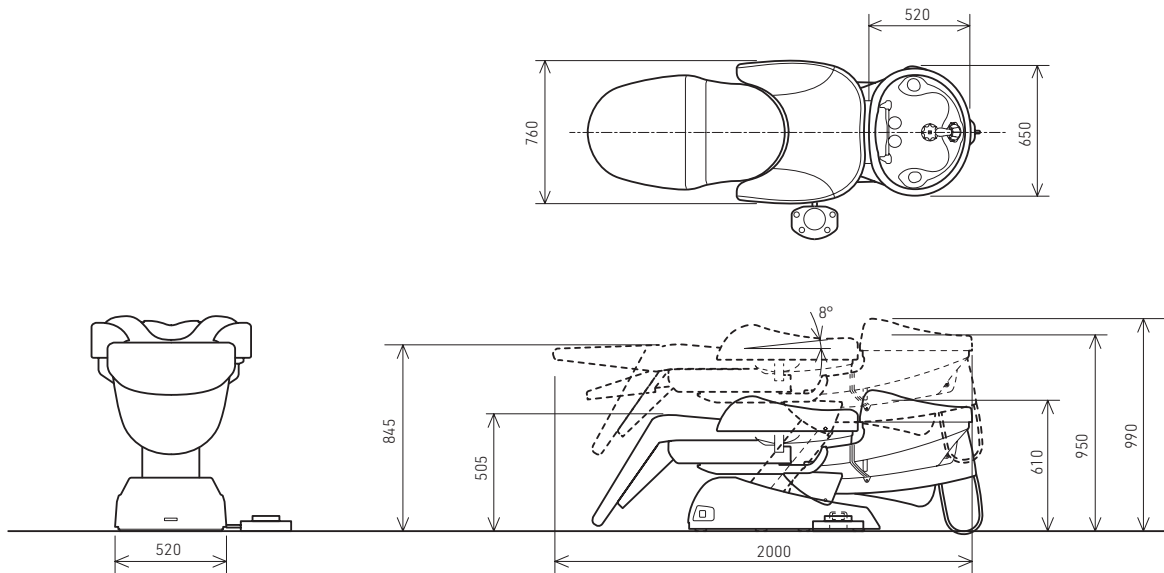

Type	----- EX-YM2*L, EX-YM2*R, SU-YM2		
Drive System	----- Motorized Hydraulic System		
Measurement	----- 760 x 2000 x 990 mm (W x L x H)		
Angle of Bracket	----- 67°(8°~75°)		
Type of Mixing	----- Thermo Mixing		
Stop Valve	----- Water x 1 (Handle Type) / Hot Water x 1 (Handle Type)		
Electrical Requirements	----- AC 110 • 120V 50/60 Hz 4.8/3.5A		
Electrical Requirements	----- AC 220V 50/60 Hz 1.7A		
Electrical Requirements	----- AC 230V 50/60 Hz 1.7A(appliance itself)		
Electrical Requirements	----- AC 240V 50/60 Hz 1.7A		
Usage Environment	----- Operational Temperature (10~40°C)		
Water and Hot Water	----- 0.1~0.4Mpa (1~4kgf/cm ²)		
Supply Pressure	----- Water Supply Pressure \geq Hot Water Supply Pressure difference between water supply and hot water supply within 0.2Mpa (2kgf.cm ²)		
Water Volume (Shower Head)	Dual function	Shower outlet	: 10.0 L/min
(water and hot water pressure are 0.1 Mpa)	shower head	Low splash foaming mode:	6.4 L/min
	YUME shower head	Shower outlet	: 10.0 L/min
Weight	----- 205 kg		

4. Overall View and Major Components

■ Main Body

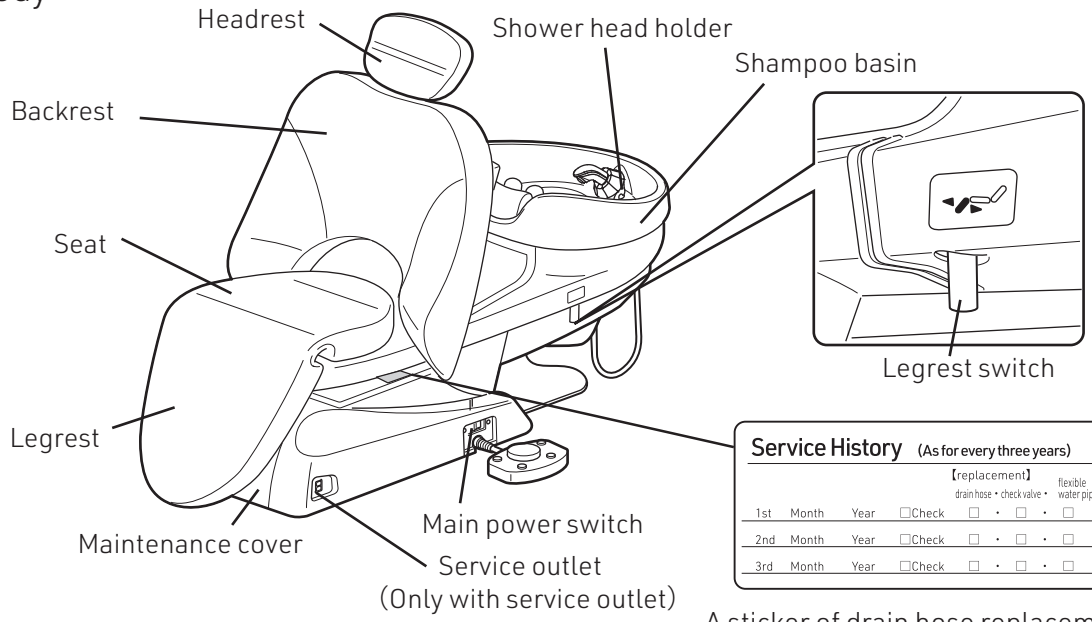

		Service History (As for every three years)		[replacement]		flexible water pipe	
				drain hose		check valve	
1st	Month	Year	<input type="checkbox"/> Check	<input type="checkbox"/>	<input type="checkbox"/>	<input type="checkbox"/>	<input type="checkbox"/>
2nd	Month	Year	<input type="checkbox"/> Check	<input type="checkbox"/>	<input type="checkbox"/>	<input type="checkbox"/>	<input type="checkbox"/>
3rd	Month	Year	<input type="checkbox"/> Check	<input type="checkbox"/>	<input type="checkbox"/>	<input type="checkbox"/>	<input type="checkbox"/>

A sticker of drain hose replacement

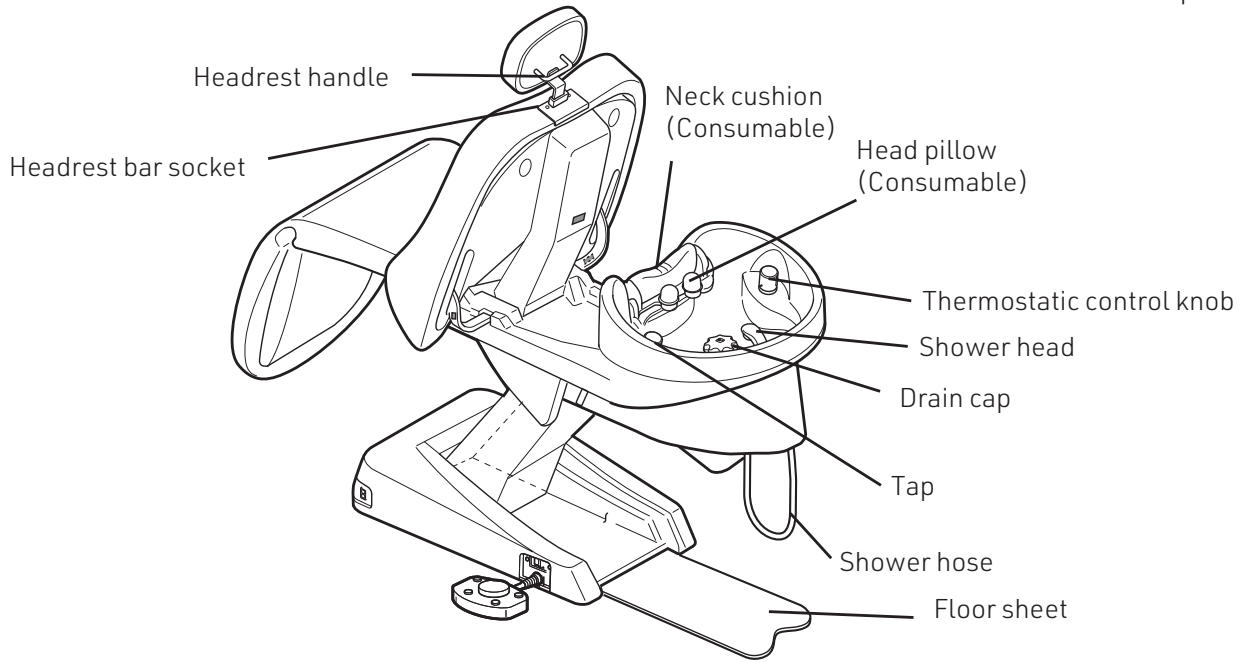

■ Foot Control

EX-YM2*LA : Left side foot control

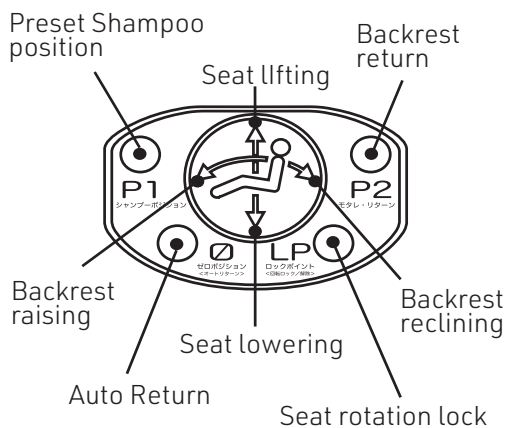

EX-YM2*RA : Right side foot control

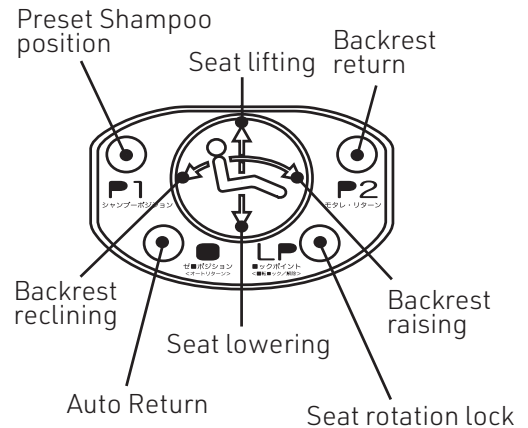

■ Leg-rest Switch

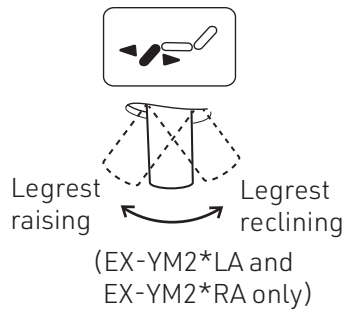

■ Shower Head Holder with Drainer

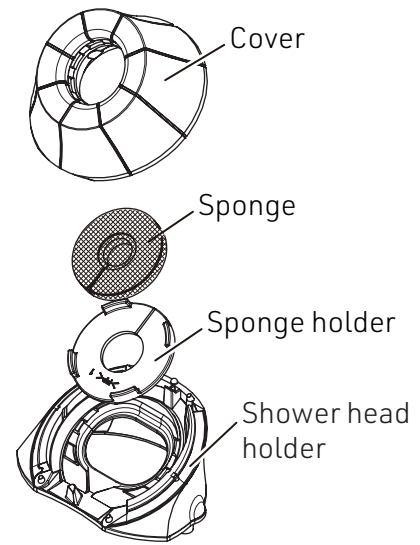

■ Shower Head

Dual Function Shower Head

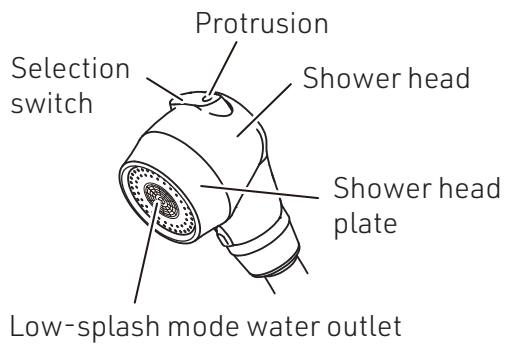

YUME shower head [OPTION]

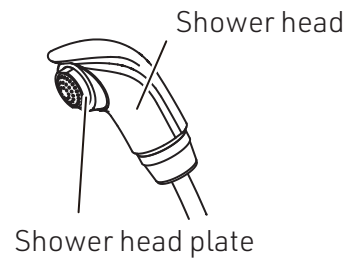

5. Accessories

Neck Cushion ...1

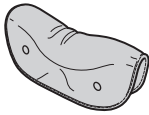

Head Pillow ...1set

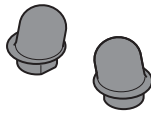

Mohair Tape ...1

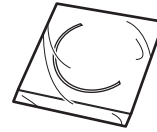

Drain Cap ...1



Hair Catcher ...1



Sponge ...1



Operation Manual ...1

Installation instructions ...1

YUME SPA Technical Manual ...1

6. Preparation

6-1. Attach the Neck Cushion

1. Attach the neck cushion on metal fittings as shown in figure.

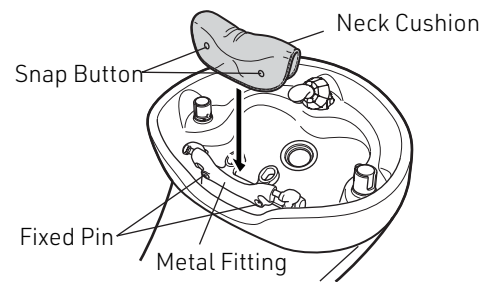

2. Both side snap button of the neck cushion is fixed on a fixed pin.

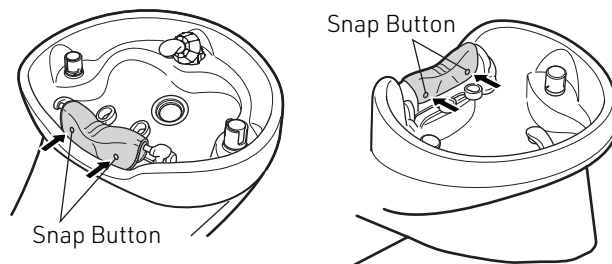

6-2. Attach the Head Pillow

1. Attach the head pillow as shown in figure.

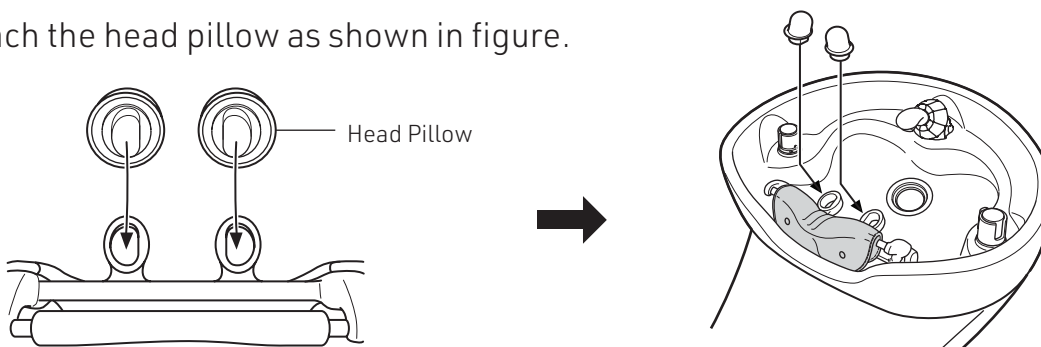

6. Preparation

6-3. Removing the cover

- 1 Turn the cover anticlockwise.
Turn the cover around 5 degrees.
- 2 Pinch the front and back of the cover to deform and remove the catch.

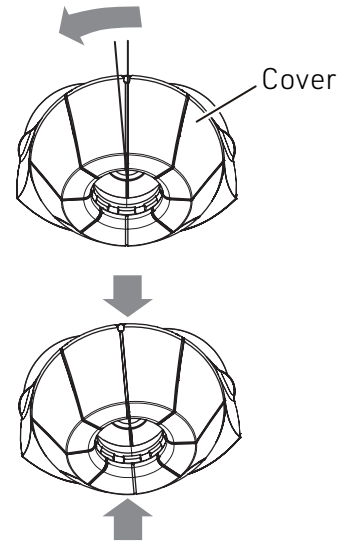
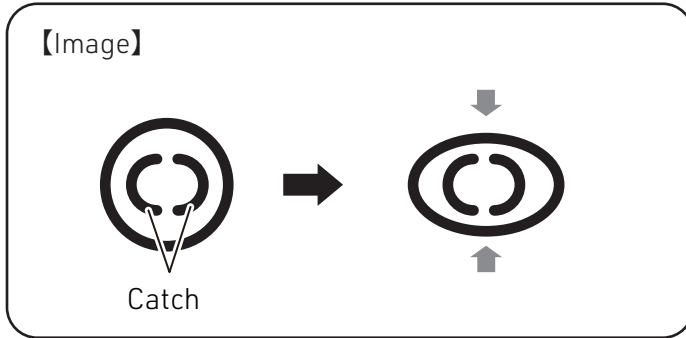

Caution

Do not remove the cover of holder forcibly.
Failure to follow the instruction may cause damage the product.

6-4. Sponge installation

Attach the sponge to the shower hose.

Attach the sponge and sponge holder to the shower hose, between the shower head holder and the cover.



Caution

Ensure that the harder side of sponge is facing upwards.

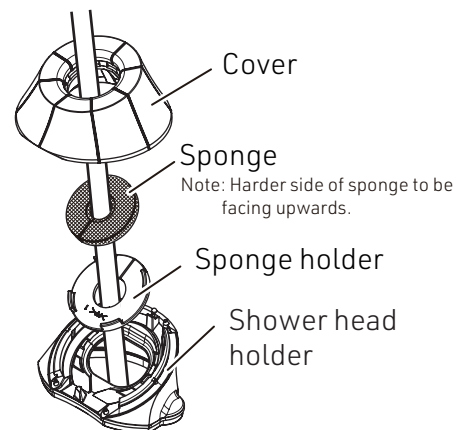

6-5. Installation of the cover

Align groove in the cover and protrusion of the holder until they snap into place.

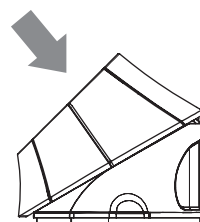
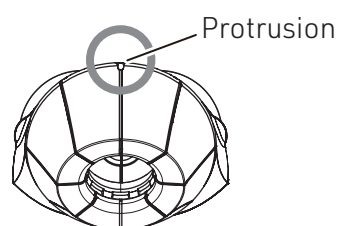

7. Operating Instruction

7-1. Main Switch

Main switch is located on the left side of the pump cover (EX-YM2*L) or on the right side (EX-YM2*R).

⚠ Caution

Turn off the main switch after daily operation
Operate the main switch by hand only.
In the event of extremely low oil temperature, "warm-up" mode may start.

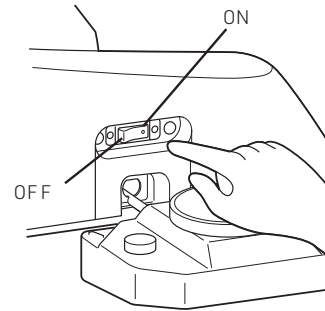

<Warm-up mode>

Warm-up operation goes on at the extremely low oil temperature. It beeps for 3 minutes until this mode completes.

7-2. Controls

Before operating the chair, confirm that it is safe for the patient and the operator.

(1) Manual Mode Control

A. Seat Lifting

Keep depressing Seat lifting switch until the seat is lifted up to the desired position.

B. Seat Lowering

Keep depressing Seat lowering switch until the seat is lowered to the desired position.

C. Backrest Reclining

Keep depressing Backrest reclining switch until the backrest is reclined to the desired position.

D. Backrest Raising

Keep depressing Backrest raising switch until the backrest is raised to the desired position.

E. Legrest Raising (EX-YM2*LA and EX-YM2*RA only)

Move leg-rest lever to the left/right side for raising and reclining.

F. Seat Rotating

Make sure to raise the backrest by depressing P2 switch rotating the seat. Momentarily press LP switch (Lock switch) releases the safety seat lock.

*The lock is not released when backrest angle is less than 30°.

Rotating the seat slowly by holding the backrest.

Press LP switch again to lock the seat at desired position.

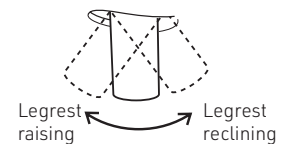
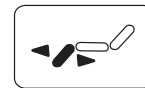
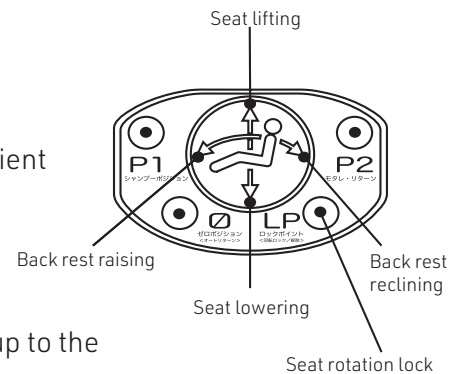

(2)Auto Mode Control

G. Preset Control

Press P1 switch a little longer (for around half second), the seat will move to the preset shampoo position automatically. (If adjustment is needed, please refer AUTO MODE POSITION ADJUSTMENT.)

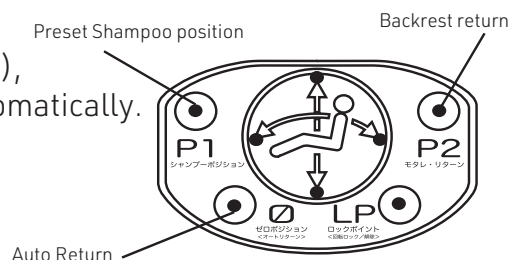

H. Auto Return

Press P2 switch a bit longer (for around half second) puts the backrest upright position automatically.

Press Auto Return switch for around half second, the seat will return to the initial position.

* Initial position : seat - lowest point , backrest - upright position

I. Emergency Stop

During automatic procedure (Preset and Auto return), depress of any side of the switches on the foot control will cancel the automatic movement immediately.

7-3. Auto Mode Position Adjustment

Preset position adjustment

- Set the seat and the backrest to the desired preset position by manual control.
- Turn off main switch.
- While depressing P1 switch, turn on main switch.
- Keep depressing P1 switch until buzzer sounds, then release it.

Warning



Take care when operating this product.

When operating this product, ensure that the customer is seated deeply in the seat and that their feet are on the leg rest, and keep an eye on them during operation. If you notice anything unusual, stop the operation immediately, especially if elderly customers or small children are seated in the seat, as the change in posture caused by the Auto Mode operation may cause unexpected strain.

Caution



Pay attention to customers and children.

Keep an eye on the customer while this product is in use. Unexpected accidents may occur if the customer (especially children) touches the operating switches or the product malfunctions due to unintentional contact. Keep children away from the product except for treatment.



Be careful of use.

The appliance is not to be used by children or persons with reduced physical, sensory or mental capabilities, or lack of experience and knowledge, unless they have been given supervision or instruction.

7-4. Safety Lock Device

Chair down movements can be stopped automatically by the safety lock device when pressure is detected between the base and the safety lock cover.

If the safety device has been activated, simply operate the seat lifting switch and remove the object causing the safety device to activate from this area.

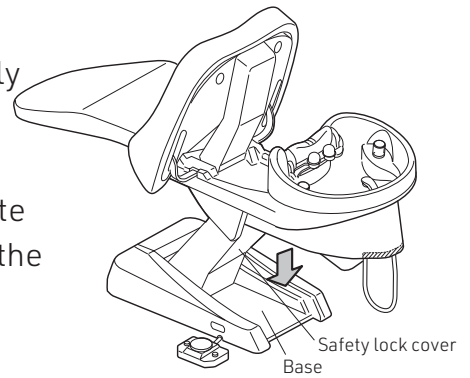

7-5. Using the Shower Head

Dual function shower head

Changing the selection switch position switches between Shower Mode and air Low-splash Mode.

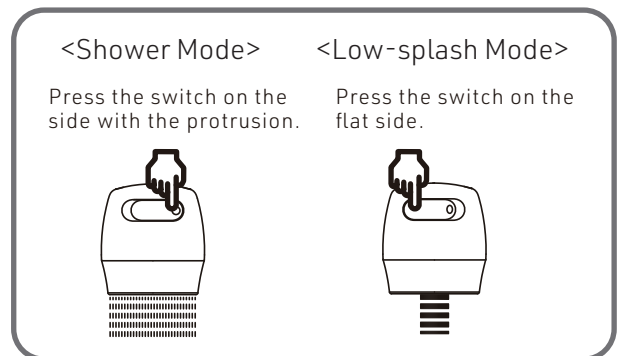
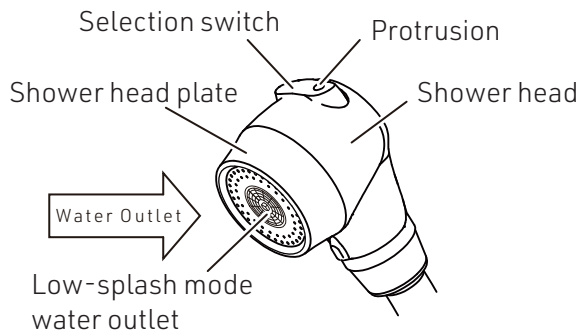

YUME shower head [OPTION]

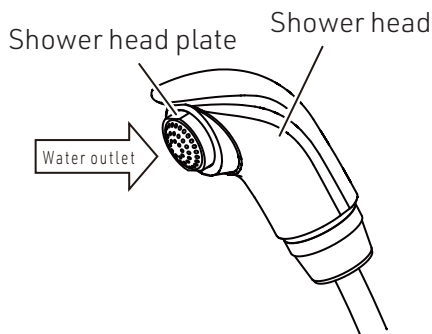

⚠ Caution

- Do not discharge a strong water stream when the shower head is in the shower head holder. Failure to take this precaution may result in system failure due to spilled water or damage to the floor.
- Return the shower head to the shower head holder after use so that the shower head plate is pointed toward the basin.

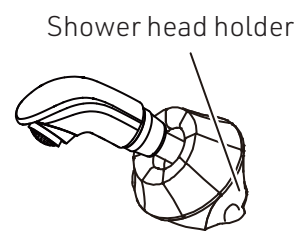
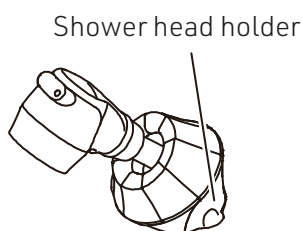

7-6. Adjustment the Water / Hot Water

- Turn the tap to counter clockwise.
- Adjust the water temperature with thermostatic control knob.
- Press stop button on the thermostatic control knob to release lock for hot water, then turn clockwise.

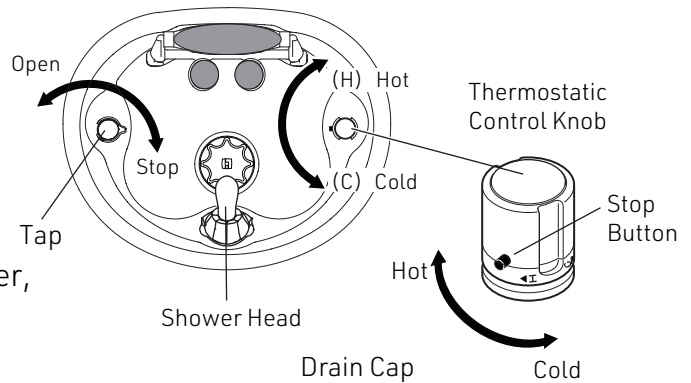

7-7. To Fill the Basin With Water

Rotate the drain cap in the clockwise direction to close the drain outlet.

To drain the water, rotate the drain cap in the counterclockwise direction to open the drain outlet.

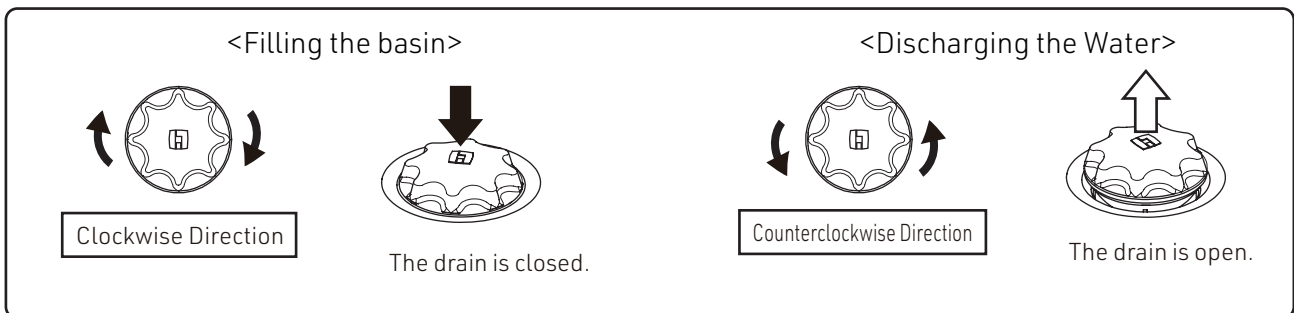
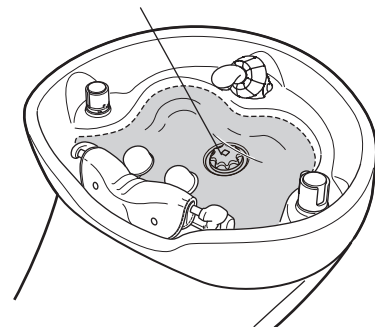

⚠ Caution

The drain cap must be detached from the drain outlet when the product is not in use. If the drain cap is not detached, the drain may accidentally close, and the water may overflow from the failure to notice water dripping, thus resulting in water leaks.

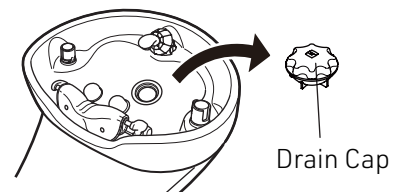

7-8. How to use Headrest (SU-YM2AM and SU-YM2BM only)

Headrest can be utilized in facial treatment and massage.
Set the backrest position to attach the headrest properly.
Attach the headrest bar to the end tightly.

7-9. How to use Service Outlet (Only with service outlet)

The unit is equipped with a service outlet on the left/right side of the pump cover.

Capacity : Up to 10A (the main unit is not in use)
Up to 8A (the main unit is in use)

Usage in excess of the maximum capacity switches off the main unit.

8. Maintenance

Notice

Do not use the following substances.

Thinner, alcohol, gasoline, kerosene or other volatile chemicals; waxes containing abrasives; sponges containing abrasives, etc.

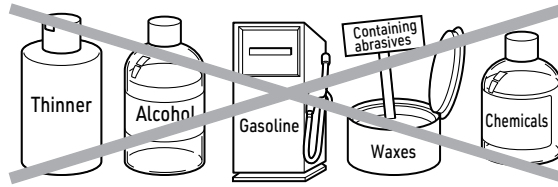

8-1. Hair Catcher

Take out the hair catcher under the drain cap and remove hairs from the hair catcher.

Caution

Clean the hair catcher as often as possible. If using the hair catcher not cleaned, it may cause clogging of the port, overflow or poor sanitary. Cleaning the hair catcher every after each shampooing is recommended.

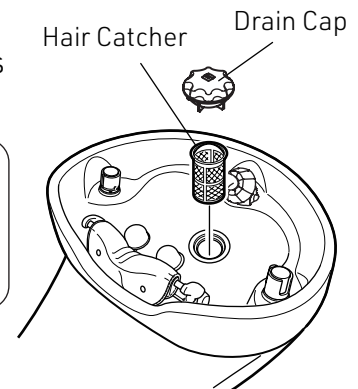

8-2. Neck cushion and head pillow (consumable parts)

Use dry cloth to wipe off water and dry in shade.

Dump cloth with neutral detergent and wipe to remove colouring or perm solution.

Caution

Rinse the cushion immediately after chemical is splashed on the neck cushion. Splashed chemical may cause deterioration or discolouration

8-3. Use dry and soft cloth to clean upholstery, plastics, plated and painted surface. Dump cloth with neutral detergent and wipe to remove stubborn stains and dirt. Use only mild neutral detergent. Use cotton buds etc. to clean around the neck cushion and head pillow mounting parts.

8-4. Drain cap

Wash around the drain cap, and remove any hair or dirt from solvents.

The drain cap is a consumable supply.

If it is extremely dirty, remove the gasket from the drain cap, wash with detergent solution diluted using water, and rinse carefully with water.

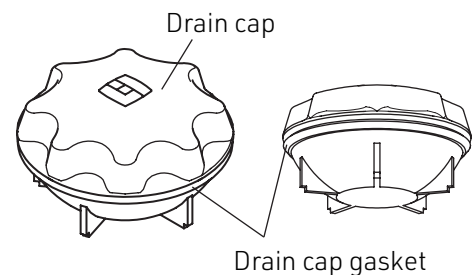

8-5. Cleaning of basin

Wipe the basin with diluted neutral detergent.

Caution

Do NOT use metal scrub brushes, paper files. Using them may be a cause of scratches.

8-6. Sponge

Sponge is consumable supply.
Replace the sponge if degradation causes rubbing sound when the hose is moving. (Available at additional cost)

Remove the cover from the holder. [Page 7]

- Remove the sponge from the hose and wash with water.
- After washing the sponge with water, squeeze it like pressing with both hands.
- Clean the sponge every day.
- After cleaning the sponge, put it in the hose and put it back on the cover.

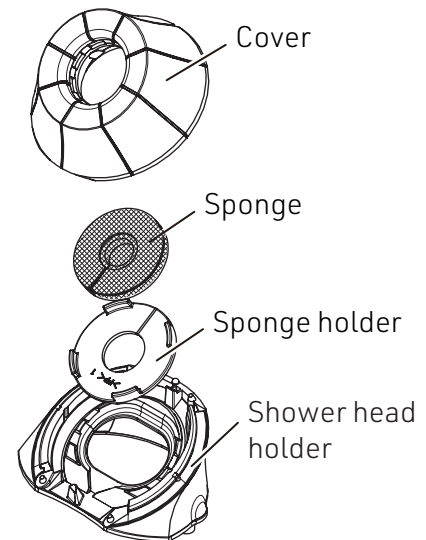

! Caution

- Please keep the sponge in the net.
If the sponge protrudes from the end of the net, return it to the net.
- Do not twist the sponge as it may damage the parts.
- Be careful not to mistake the direction of the sponge.
The harder side is above.

8-7. Shower head holder cover

Replace the cover if it easily comes off repeatedly when the hose is moving. (Available at additional cost)

[Replacement method]

- 1** Remove the shower head.
(The figure on the right)
- 2** Remove the cover from the shower hose.
Push the socket to remove the cover.
- 3** Install a new cover.

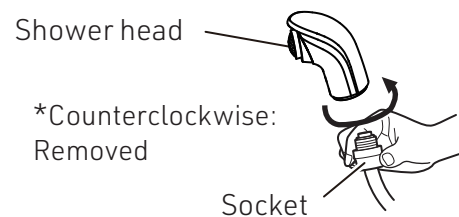

Tips for installation.
Put the socket into a plastic bag and push the cover to make it easier to enter.

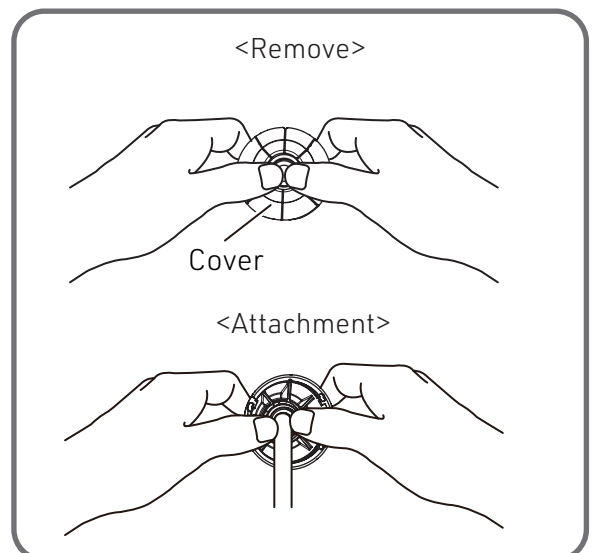

8-8. Strainer for check valve

Clean strainer (built-in check valve) at regular intervals.

Remove the water in strainer if freezing is expected in the cold district.

- A. Raise the chair and turn off the main switch.
- B. Remove 2 screws and open the maintenance cover
- C. Place cloths near the water / hot water supplise.

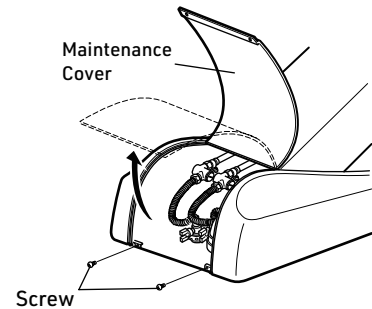

- D. Turn off the water & hot water stop valves and remove strainer by flat head screw driver and wipe off the water by cloth.

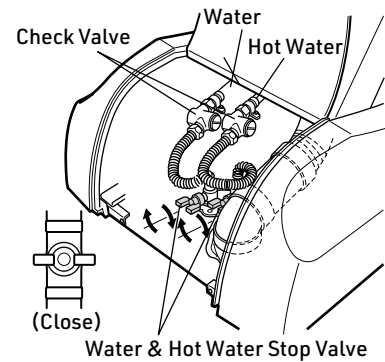

- E. After cleaning the strainer, put it back and tighten up.
- F. Wipe water off and remove cloth.

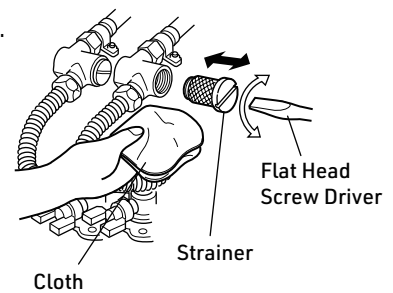

- G. Turn on the water & hot water stop valves.
- H. Close the maintenance cover and install 2 screws.

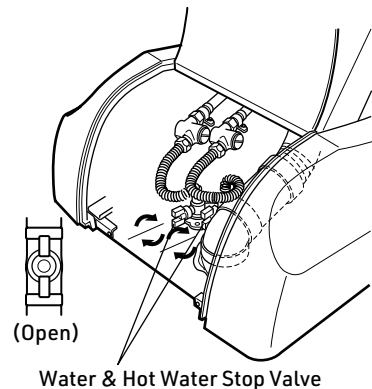

Water leak check

Open the maintenance cover and check water leakage once a week.

9. Troubleshooting

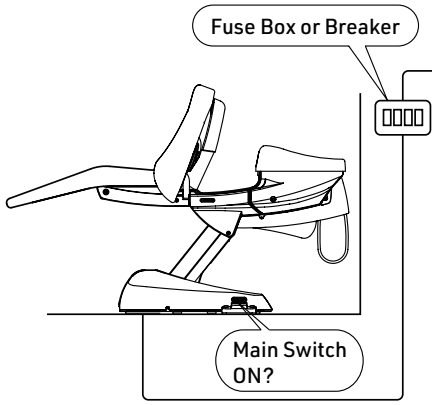
Symptom	Check
<ul style="list-style-type: none"> ● Seat and backrest doesn't move 	<ul style="list-style-type: none"> ○ Make sure that the power plug is properly plugged into the outlet. ○ Make sure that the main switch has been turned on.
 <p>The diagram shows a chair with a callout box pointing to a 'Fuse Box or Breaker' on the wall. Another callout box points to a 'Main Switch ON?' on the chair's base.</p>	<ul style="list-style-type: none"> ○ Check the fuses in your fuse box to make sure they haven't burned out. If you have a breaker box, check for tripped breakers. ○ After the long time operation, Over temperature protection system works. Please leave the chair for 10 minutes and start operation. Unplug the machine and then plug it in again and see if it will operate.
<ul style="list-style-type: none"> ● No Water / Hot Water 	<ul style="list-style-type: none"> ○ Make sure that the water & hot water stop valve has been turned on.
<ul style="list-style-type: none"> ● The temperature of hot water is too low 	<ul style="list-style-type: none"> ○ Check to make sure that the temperature setting of water supply tank is properly. ○ Make sure that the temperature setting of the chair is properly.
<ul style="list-style-type: none"> ● Slow drainage 	<ul style="list-style-type: none"> ○ Check to make sure that the hair removed from the hair catcher completely.

In case other than those listed above, contact our service center or sales office.

Caution

If the supply cord is damaged, it must be replaced by the manufacturer or its service agent or similarly qualified person in order to avoid hazard.

10. Parts Replaced on a Regular Basis

The following are parts that must be replaced on a regular basis as designated by our company:

□ Drain hose: Replace every three years

- For the drain hose, there is a possibility that water leaks will occur because cracks are caused due to deterioration and hardening of the hose from chemical agents in the drain water.
- Damage to the hose may result in water flooding on or beneath the floor.

□ Check valve: Replace every three years

- When the check valve is used continuously for long periods of time, there is a possibility that the parts in the valve will deteriorate resulting in no water discharging, or sometimes, the sewage water once discharged from the water faucet will flow back, thus causing contamination of city water or public health problems.

□ Water/hot-water supply hose: Replace every three years

- For the water/hot-water supply hose, there is a possibility that cracks due to deterioration caused by equipment operation or residual chlorine or copper ions in the city water will cause water leaks.
- Damage to the hose may result in water flooding on or beneath the floor.

The above-listed parts must be replaced on a regular basis to ensure and maintain safety and performance.

Any part that is outside the designated replacement period must be replaced even if there is no problem during use. (The parts are available at additional cost.) Our company will not assume responsibility for any harm, damage, or defects attributed to any part that was not replaced within the designated period.

For ordering replacement work, contact your local Takara Belmont dealer.

11. Consumable Supplies

The following parts are "consumable supplies" and wear, degradation, changes in external appearance and damage are expected.

Please note that repair or replacement of these parts is not covered by warranty, and a fee will be required.

(* The level and period of wear, degradation or damage may differ depending on the environment and conditions that the customer uses this product in.)

Inspections or replacement of parts will be required if there is extensive wear, degradation or damage.

Consumable supplies (the following parts are not covered by warranty, and a fee will be required.)

- Neck cushion
- Head pillow
- Drain cap
- Hair catcher
- Sponge
- Shower head holder cover
- Mohair tape
- Shower hose
- Rubber gaskets
- Lubricant (oil, grease, etc)

External scratches or dirt, degradation or fading of the following external parts are not covered by warranty.

* External parts

- Covers, frames, basin
- Floor sheet
- Leathered surfaces (backrest, seat, legrest)
- Taps (such as water tap, thermostatic control knob)
- Other (such as shower head, shower head holder etc.)

MEMO

IMPORTER INFORMATION

COUNTRY		REGISTERED PLACE OF BUSINESS & ADDRESS
GBR	Importer in UK	TAKARA BELMONT(U.K.)LTD. BELMONT HOUSE, ONE ST.ANDREWS WAY, BOW LONDON E3 3PA, ENGLAND
DEU	Importeur in Deutschland	TAKARA COMPANY EUROPE GmbH BERNER STRASSE 18, 60437 FRANKFURT/M, GERMANY
FRA	Importateur en France	TAKARA COMPAGNIE PARIS S.A.R.L. 56 rue des Hautes Pâtures 92009 NANTERRE Cedex France
ITA	Importatore in Italia	TAKARA BELMONT ITALY S.R.L. Via Marino Mazzacurati No.4/1, 42019 Scandiano RE, Italy

EU Declaration of Conformity

We hereby declare that the product listed below complies with the essential requirements of the EMC (electromagnetic compatibility) Directive : 2014/30/EU, Low Voltage Directive : 2014/35/EU, Machinery Directive : 2006/42/EC and RoHS Directive : 2011/65/EU based on category 11 of Annex I.

Product : BEAUTY SHAMPOO UNIT

Model : YUME DX

The product has been designed and manufactured in accordance with the European standards as the listed in the Declaration of Conformity.

UK DECLARATION OF CONFORMITY

We declare under sole responsibility that the device that is covered by the present declaration is in conformity with the following regulations and, if applicable, with any other relevant UK legislation that provides for the issuing of an UK declaration of conformity.

Product : BEAUTY SHAMPOO UNIT

Model : YUME DX

Regulations this product conforms to:

The Electrical Equipment (Safety) Regulations 2016, S.I. 2016/110

The Electromagnetic Compatibility Regulations 2016, S.I. 2016/1091

The Supply of Machinery (Safety) Regulations 2008, S.I. 2008/1597

The Restriction of the Use of Certain Hazardous Substances in Electrical and Electronic Equipment Regulations 2012, S.I. 2012/3032 based on category 11 of PART 1, SCHEDULE I

EU Authorised representative

TAKARA COMPANY EUROPE GmbH

Berner Strasse 18, 60437
Frankfurt am Main, Germany



UK Authorised representative

TAKARA BELMONT(U.K.)LTD.

BELMONT HOUSE, ONE ST.ANDREWS WAY, BOW
LONDON E3 3PA, ENGLAND



TAKARA BELMONT CORPORATION

2-1-1, Higashishinsaibashi, Chuo-ku, Osaka, 542-0083, Japan