

## SPA MIST II

Model AK-160

Operating Instructions

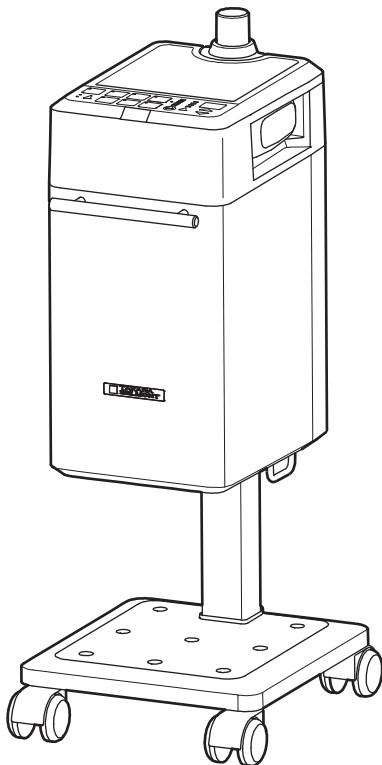

## Table of Contents

Safety Precautions (To be strictly observed) 1

Name of Each Part..... 4

Location of Warning Label..... 4

Accessories/Optional Items ..... 5

Control Panel..... 7

Description of Keys..... 7

Default Setting of Modes ..... 9

Change and Memorization of Setups 9

Preparation ..... 10

Operation Procedures..... 12

Installing/Detaching the Mist cap (Option) 19

Using the Open Mist Ball Nozzle (Option) 24

Using the Aromatherapy Diffuser Holder (Option) 25

Care and Cleaning ..... 26

State Indication..... 27

Before Asking for Repairs ..... 28

Disposing of the Product..... 28

Consumable Supplies (Including Options) 29

Guidance on Daily Inspection..... 29

Main Specifications ..... 30

# Safety Precautions (To be strictly observed)

## Before Using the Product

Carefully read the "Safety Precautions" and use the product correctly.

For safe use of the product, be sure to perform the daily inspection following the procedures described in Guidance on Daily Inspection (page 29). In case the product is continually used without performing daily inspections, product failure or accidents may occur.

## Precautions stated here are for the purpose of the following:

Ensuring safe use of the product and preventing harm and damage to yourself and other persons. Each of the precautions identifies an important item concerning safety. Be sure to observe them. The following section provides detailed explanations of the precautions. Fully understand the meaning before reading the body text.



**WARNING**

Improper handling of the product and failure not to heed this warning will lead to critical risks that may result in death or serious personal injury.



**CAUTION**

Should this indication be neglected and the product be handled improperly, the possibilities of minor physical injuries, mild physical disorder, or material damages are increased.



Indicates general prohibited behaviors.



Indicates prohibition of water splashing and use near water.



Indicates prohibition of disassembly, repair, or modification.



Indicates enforcement or instruction of general user behaviors.



Indicates the instruction to disconnect the power plug from the outlet.



Indicates the necessity for paying attention to high temperatures.



**WARNING**

Do not insert a hand or foreign matter into the water-supply bottle.

Do not climb onto or lean against the machine or the stand.



The inside of the machine is hot. Do not insert hands or fingers into the machine since doing so may result in burns.



Ignoring this precaution may result in injuries due to falling or sudden move of the machine since the stand and wagon are on casters.



When foreign matter other than water enters the machine, machine operation may become abnormal, and it may catch fire or physical injuries may result. Should foreign matter enter the machine, immediately stop using the machine, and contact the nearest dealer or our company directly.

Think of the physical condition of the customer.













The head of the customer will become warm due to the mist during operation. Should the customer feel sick, stop using the machine. Particular attention should be given to those who are likely to feel dizzy, have high blood pressure, or are concerned about their physical condition.

# Safety Precautions (To be strictly observed)





## WARNING

Disconnect the power plug before fixing the product.	Do not expose the machine to water.
 <p>Be sure to disconnect the power plug when fixing the product. Do not do this with wet hands. Ignoring this precaution may result in electrical shock hazard or injury.</p>	 <p>Do not expose the main unit parts directly to water nor wipe them with a wet waste cloth. Ignoring this precaution may result in electrical shock hazard or ignition.</p>
Warning concerning Power Supply	Never disassemble or repair the machine by yourself.
 <p>Be sure to disconnect the power plug from the outlet after closing the work for the day or when the product is not used for a long period of time on holidays. Ignoring this precaution may result in electrical fire due to deteriorated insulation.</p>	 <p>Persons other than the repair engineer must not disassemble, repair, or modify the machine. Ignoring this precaution may cause ignition or abnormal operations, thus resulting in physical injuries.</p>
 <p>Be sure to turn off the power to the main unit each time the work is completed. Be sure to disconnect the power plug before moving the product.</p>	Never touch the parts inside the product.
 <p>If the blades or the area near the blades of power plug is contaminated with waste hair or chemical agents, wipe the area well with a dry cloth.</p>	 <p>Never touch the parts inside the product since there is a possibility of an electric shock hazard. Be sure to ask the after-sales division of our company for maintenance of the product.</p>
Never put any flammable substance into the water-supply bottle.	Do not practice in different operation modes.
 <p>Never put kerosene oil, gasoline, thinner, benzene, alcohol, etc., into the water-supply bottle. Ignoring this precaution may result in explosion or fire.</p>	 <p>Be sure to practice in the mode that is adequate for the practice. Using the machine in the wrong mode may result in burns or injuries.</p>
Never put any flammable substance into the water-supply bottle.	Do not operate the machine in a tilted or an inverted state.
 <p>Never put kerosene oil, gasoline, thinner, benzene, alcohol, etc., into the water-supply bottle. Ignoring this precaution may result in explosion or fire.</p>	 <p>Ignoring this precaution may cause water leakage into the electrical parts inside, resulting in an electric shock hazard, short circuit, or fire.</p>

















## CAUTION

Pour off the water remaining inside the machine and in the drain tank when closing the work.	Do not put chemical agents or easy-to-fall objects on the detachable tray.
 <p>When closing the work, drain the water remaining inside the machine and pour off the water into the drain tank. Ignoring this precaution may result in deterioration of water or machine failure.</p>	 <p>Do not put chemical agents or easy-to-fall objects on the detachable tray. Do not use the tray if cracks or flaws are noted on it. Do not move the tray with an object on it. Ignoring this precaution may result in breakage of the removable tray or physical injuries.</p>

# Safety Precautions (To be strictly observed)

## CAUTION

<p><b>Handling of Power Cord</b></p> <p> When disconnecting the power plug, do not hold it at the cord, but pull it out while holding the plug part at the end.</p> <p> Be sure to use the power cord in the state where it is affixed to the main unit with the screws attached (see page 4). Ignoring this precaution may result in fire or electric shock hazard.</p> <p> If the power cord or the power plug is damaged or when with the connection to the wall outlet is loose, do not use the cord or the plug.</p> <p> Do not move the main unit by holding the power cord. Do not damage, break, forcibly bend, twist, pull, or bundle the cord. Furthermore, putting a heavy object on the cord, jamming of the cord into objects, or modifying the cord will damage the cord, resulting in fire or electric shock hazard.</p>	<p><b>Do not put hot water into the water-supply bottle.</b></p> <p> Do not put hot water into the water-supply bottle. When you do this, burns, machine errors, or machine failure may result.</p> <p><b>Do not touch the water-supply cap when it is hot.</b></p> <p> Do not touch the water-supply cap during operation or right after the operation. Since the cap is hot, burns may result.</p> <p><b>Do not flush the inside of the water-supply bottle pan with a flushing agent.</b></p> <p> Ignoring this precaution may result in machine failure or physical injuries caused by malfunction of the machine.</p> <p><b>Do not put a heavy object on the main product unit.</b></p> <p> Do not put an object exceeding 1 kg on the machine. Ignoring this precaution may result in burns or physical injuries caused by falling, deformation, or breakage of the machine.</p>
<p><b>Do not put your hands and legs closer to the drain outlet when discharging water.</b></p> <p> When discharging water, do not put your hands, legs, etc., into the drain outlet. Hot water may come out of the outlet, which may cause burns or injuries.</p>	<p><b>Do not use parts and components other than the designated options.</b></p> <p> Ignoring this precaution may prevent normal use and may cause burns or physical injuries.</p>
<p><b>Pay attention to interference with other equipment and jamming.</b></p> <p> When moving the machine or other equipment, be careful about interference or jamming. Ignoring this precaution may result in falling or breakage of the machine or physical injuries.</p>	<p><b>Do not operate the machine without installing the flexible hose.</b></p> <p> Operation of the machine without installing the flexible hose will allow the mist to be sprayed onto the machine, which may result in electric shock hazard, electric leakage, or short circuit.</p>
<p><b>Never put liquids other than deionized water into the water-supply bottle pan.</b></p> <p> Never put liquids such as perm solution, essence face lotion, aromatherapy oil, and mineral water other than deionized water into the water-supply bottle or the water-supply bottle pan. Ignoring this precaution may result in machine failure.</p>	<p><b>Do not use chemical agents that are designated for use in room temperature.</b></p> <p> Do not use alkali color or cold 2-bath permanent-waving agents. Ignoring this precaution may cause skin infections, such as a rash.</p>

# Name of Each Part

## Standalone Type

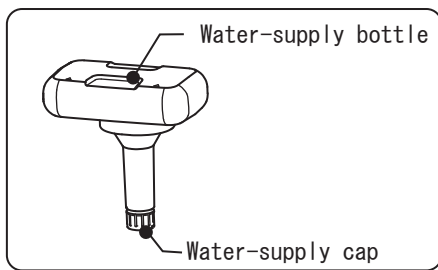
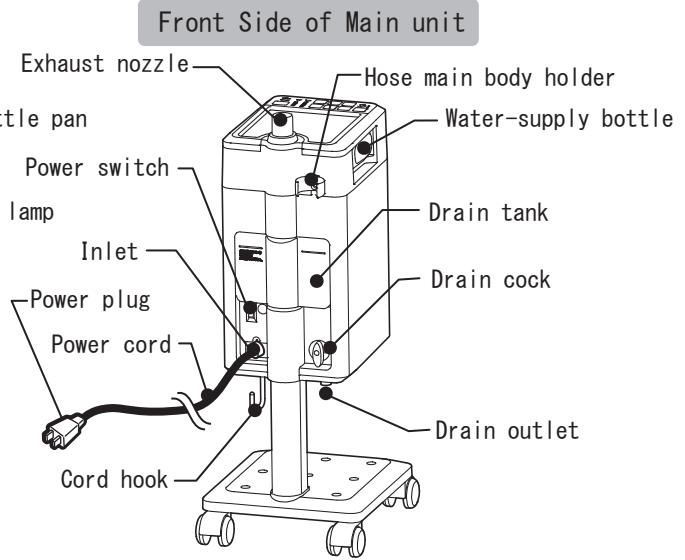
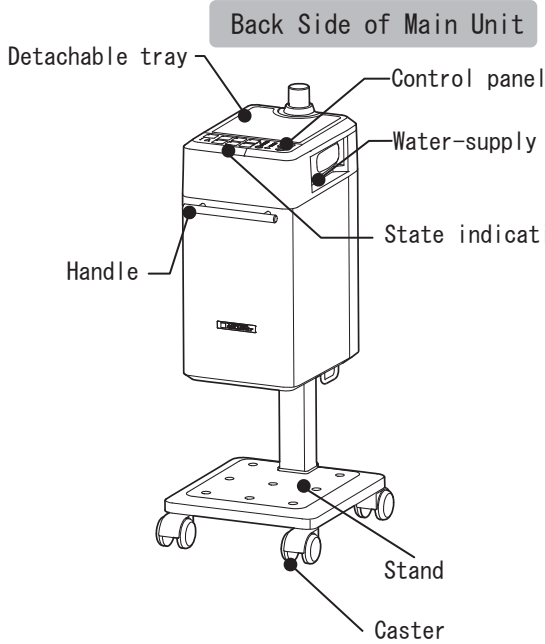

## Wagon Type

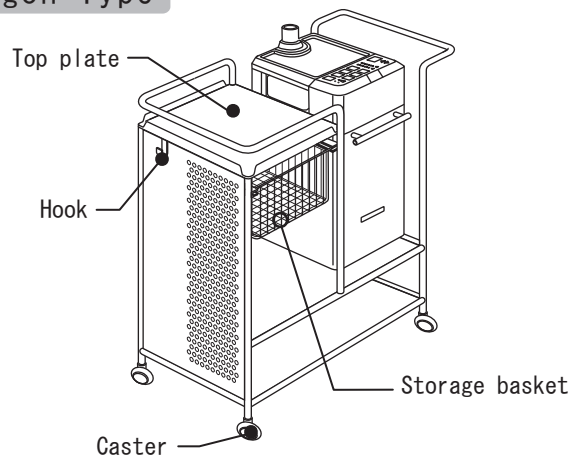

# Location of Warning Label

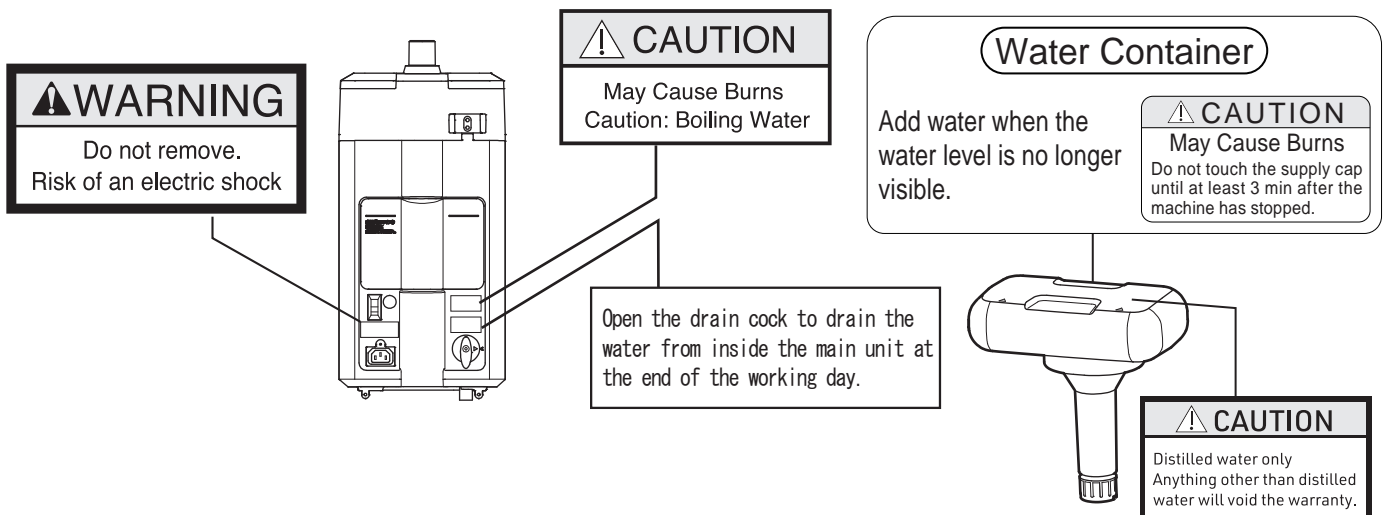

# Accessories

Check that all of the following accessories are provided.

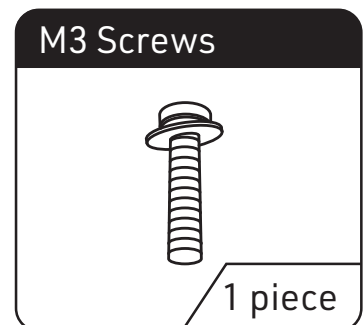
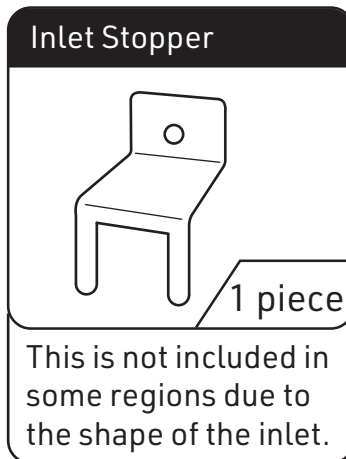
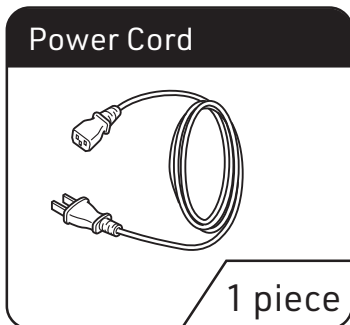
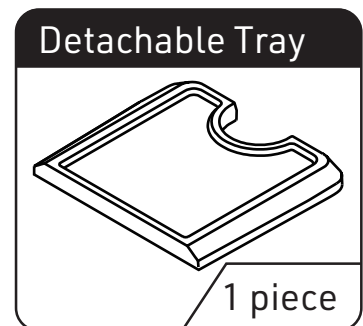
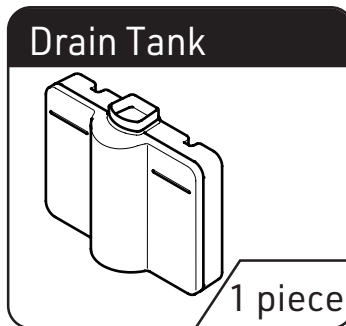
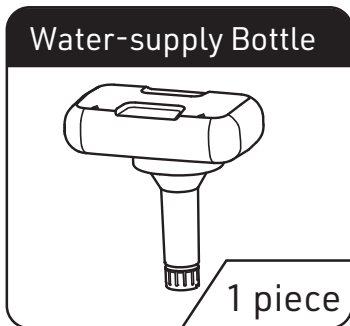
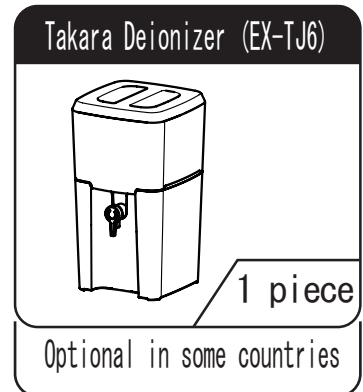
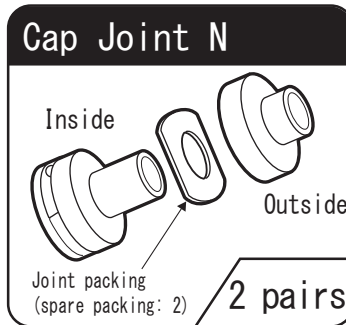
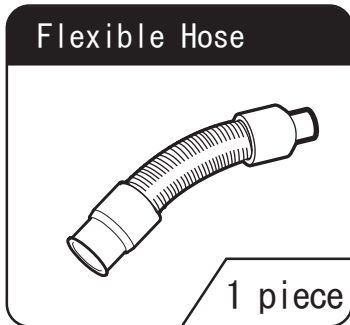

Operating Instructions (This manual)

# Options

(Standard accessories in some countries)

※ Options are sold separately.

For purchasing the options, contact the nearest dealers or our company directly.  
(See page 31 "Information.")

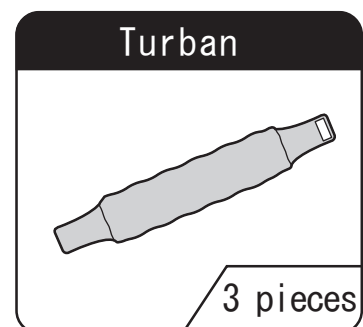
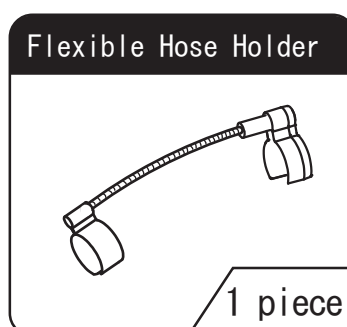
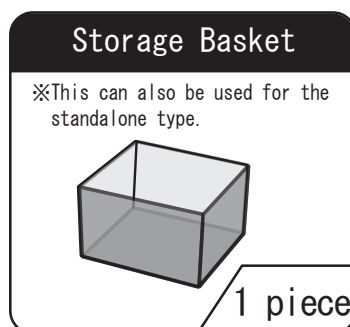
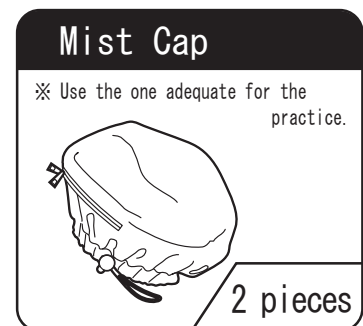
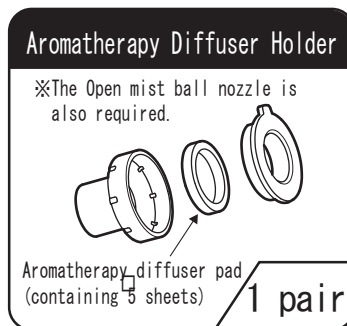
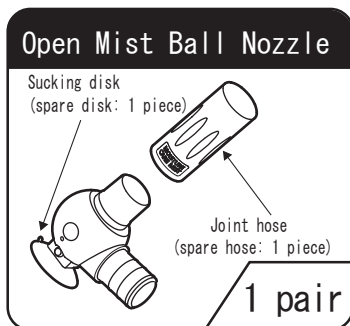

# Control Panel

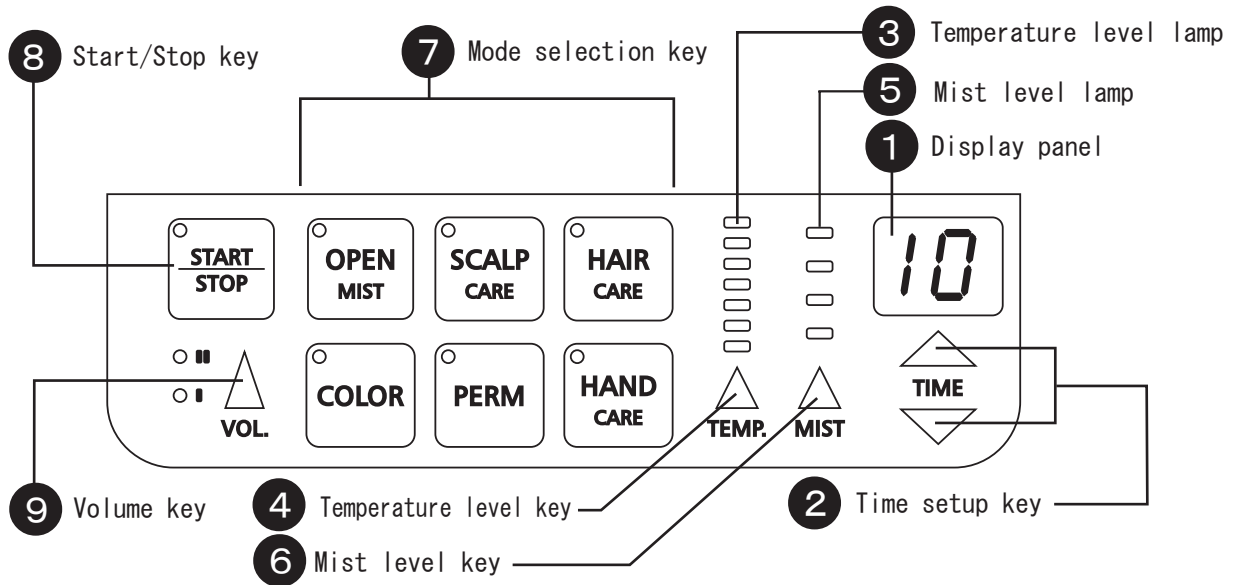

## Description of Keys

### 1 Display Panel



(Example)

- Display the operation time you set.
- Display the remaining time until the completion of operation.
- Display the elapsed time after the completion of operation.
- ※ Depending on the mode, the cooling function is activated after the completion of operation and either of displays  $\overline{C0}$  to  $\overline{C5}$  is displayed.



(Example)

- Display the operation status such as preheating. See page 27 "State Indication."

### 2 Time Setup Key



- Use this key to change the setting time.
- Either for the  $\triangle$  (UP) or the  $\nabla$  (DOWN) key, each press of the key increases or decreases the time in units of one minute. Furthermore, a continuous press on the key increases or decreases the time in units of five minutes.

### 3 Temperature Level Lamp



- Display the temperature level in eight steps.

Level	1	2	3	4	5	6	7	8	
Temperature	Low $\longrightarrow$ High								
Lamp color	OFF	Green	Yellow	Orange	Red				

### 4 Temperature Level Key



- Use this key to change the mist temperature. Each press of the key increased the level by one step and returns to Level 0 when Level 7 is reached. (Level 0 shows the heater OFF state.)

### 5 Mist Level Lamp



- Display the mist level in four steps.

Level	1	2	3	4
Mist Amount	Small $\longrightarrow$ Large			
Lamp Color	Green			

### 6 Mist Level Key



- Use this key to change the mist amount. Each press of the key increased the level by one step and returns to Level 1 when Level 4 is reached.









# Description of Keys

## 7 Mode Selection Key and Lamp (The lamp illuminates when the key is turned on.)

When a mode is selected, the temperature level you set, mist level, time, etc., are indicated.

※The cooling time (Enabled / Disabled) will be set according to the mode.

<p><b>Open Mist</b></p>  <p>Lamp</p> <p>Use this key during shampoo or massage when chemical agents such as cleansing liquid, treatment liquid, etc., are applied during shampoo or in the Spa Menu. ※The mist cap is not used.</p>	<p><b>Color</b></p>  <p>Lamp</p> <p>Use this key to warm up treatment of the acidic hair dye (hair manicure, etc.). ※Cooling time: 5 minutes Use the dedicated mist cap.</p>
<p><b>Scalp Care</b></p>  <p>Lamp</p> <p>Use this key when warming up the scalp before or after applying the scalp cleansing agent, and for enhancement of the scalp treatment agent. ※Use the dedicated mist cap.</p>	<p><b>Perm</b></p>  <p>Lamp</p> <p>Use this key to warm up the treatment of the heating-type permanent wave agent or the curling agent, which is classified as a cosmetic. ※Use the dedicated mist cap.</p>
<p><b>Hair Care</b></p>  <p>Lamp</p> <p>Use this key to warm up the hair after applying the hair treatment agent. ※Cooling time: 2 minutes Use the dedicated mist cap.</p>	<p><b>Hand Care</b></p>  <p>Lamp</p> <p>Use this key to warm up the hand when the cosmetic for hand care is applied or during massage. ※No cap, etc., is used.</p>

**Information** The standard setup time for each mode can be changed for desirable conditions and can be memorized. As for the details, see page 9.

## 8 Star/Stop Key and Lamp (The lamp illuminates when the key is turned on.)



- Use this key to start the preheating.
- Use this key to cancel the preheating.
- Use this key to start the operation after completing the preheating.
- Use this key to interrupt the machine operation while the machine is in operation.
- Use this key to resume the operation while the machine operation is interrupted.

## 9 Volume Key and Lamp



- Sound volume of the buzzer for announcing key operations and process completion can be set.
- One of the lamps illuminates according to the sound quality.  
Mute: OFF (\* The error sound will not be off.)  
Level 1: One lamp will illuminate.  
Level 2: Two lamps will illuminate.
- To memorize the sound volume you set, press and hold the Start/Stop key for two seconds.  
(When the memorization is completed, two short electronic sounds are generated to indicate the status.)  
※This function is effective only before selecting the mode after turning on the power.

# Default Setting of Modes/Change and Memorization of Setups

## Default Setting of Modes

Mode	Default Setting			
	Time	Temperature Level	Mist Level	Cooling
Open Mist	60 minutes	6	3	N/A
Scalp Care	5 minutes	5	3	N/A
Hair Care	8 minutes	5	3	2
Color	15 minutes	4	1 ※ <sub>1</sub>	5
Perm	10 minutes	3	1	N/A
Hand Care	5 minutes	2	1	N/A

※<sub>1</sub> Color Mode

The default setting is set to Mist Level 1, considering dripping, etc.

If you want to enhance the dyeing capacity, increase the mist level, paying attention to dripping when using the color mode.



### CAUTION

Do not execute cap practice under the open mist mode. When you use the machine at a high temperature level, the temperature in the cap will become higher, which may cause dizziness or burns.

### Standard Temperature in Mist Cap at Respective Levels

Temperature Level	Open Mist Mode Only							
	0	1	2	3	4	5	6	7
Standard Temperature in Mist Cap (°C)	—	36	39	42	45	48	50	52

※The standard temperatures in the mist cap are reference values measured about five minutes after starting operation. (Results of measurement by our company at a room temperature of 25° C)

The standard temperatures in the mist cap will fluctuate according to the operation environment such as room temperature or the operating condition.

## Change and Memorization of Setups

- 1 Set the modes to the desired conditions by referring to the table shown above.  
 ※The maximum temperature level, enabling and disabling cooling, and cooling time cannot be changed.
- 2 To memorize the setup you changed as the standard setup, press and hold the key for the mode presently chosen for two seconds or longer.  
 Upon completion of the memorization, short electronic beeping sounds will indicate that the setting has been saved.  
 ※To restore the memorized setup to the default setup, turn off the power once, and then turn it on while pressing the Start/Stop button.

# Preparation ( For cases other than the cap practice, also see the method for using the appropriate option. )

- 1 Attach the cap joint N to the mist cap (option).**  
(For cases other than the cap practice, also see the method for using the appropriate option.)

Be careful about the fixing direction of the [UP] mark on the inner cap joint N.

Type of Mist Cap	Direction of Inner Cap Joint N
For YUME and open mist ball nozzle For rear shampoo and YUME For styling chair and perm/color	Install the joint with the markset in the [UP] direction.
For CALME and men's chair	Install the joint with the markset in the [UP] direction.

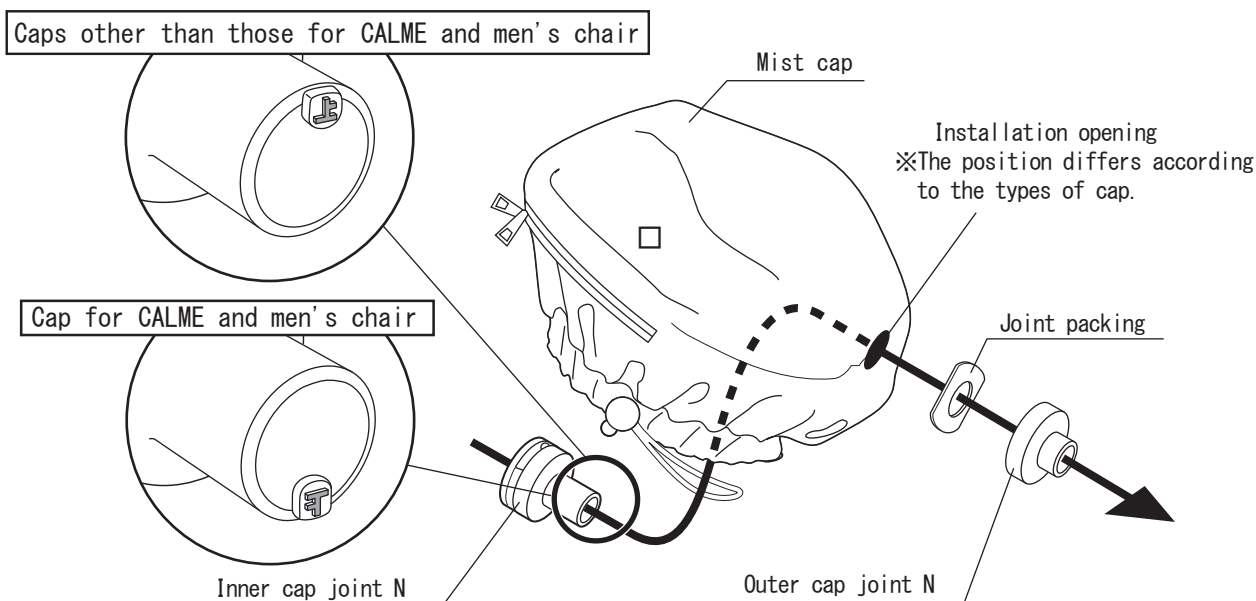

**Information** Be sure to use the dedicated mist cap and the cap joint N.  
Be sure to install the joint so that the [UP] mark on the inner cap joint N faces the correct direction when using the mist cap.

The mist cap (consumable item) is an option.

For purchasing the cap, contact the nearest dealer or our company directly. See page 31 "Information."

## List of Mist Caps for SPA MIST II

Type	Product Code	
For hair care and scalp care (white)	For YUME and open mist ball nozzle (containing 2 pieces)	EA-CMC-YB
	For rear shampoo, YUME (containing 2 pieces)	EA-SMC-RSW
	For styling chair (containing 2 pieces)	EA-SMC-SW
	For CALME and men's chair (containing 2 pieces)	EA-SMC-CA
For perm/color (silver)	Large (for perm) and small (for color), 1 piece each	EA-SMC-PC
	Large (for perm), Set of 2 pieces	EA-SMC-PCB
	Small (for color), Set of 2 pieces (the same size as the cap for treatment)	EA-SMC-PCS

# Preparation

## 2 Pour water into the water-supply bottle.

### 1 Remove the water-supply cap and pour water.

※Be sure to use the water Takara Deionizer (EX-TJ6) that comes with the product or the purified water ST0 (BM-ET1) dedicated for the machine. Be sure to use the dedicated water-supply bottle and the water-supply cap.

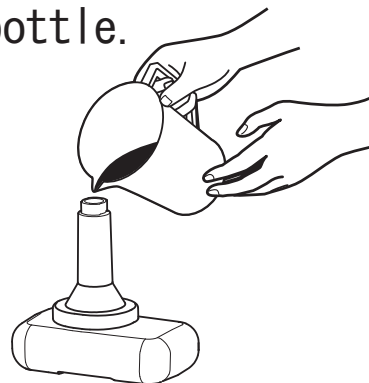

- Do not use the water-supply bottle if breakage or cracks are noted. Ignoring this precaution may cause the **DF** error (see the "State Indication" on page 27) or water leakage.
- Never use any liquids, such as the perm solution, essence cosmetic liquid, aromatherapy oil, and mineral water other than the deionized water or the purified water dedicated for the machine. Ignoring this precaution may result in machine failure.
- When the machine is continuously used without using the Takara Deionizer, impurities will attach to the heater in the machine, thus causing machine failure or accidents.
- Do not pour hot water into the water-supply bottle. When you do this, burns, abnormal machine operation, or failure may result.
- Do not touch the water-supply bottle or the water-supply cap during operation or right after operation. The bottle or the cap is hot, which may cause burns. Feeding water should be done after the water-supply bottle or the water-supply cap has been sufficiently cooled down.

### 2 Close the water-supply cap.



Be sure to close the cap tightly. Ignoring this precaution may result in an **DF** error ("State Indication" on page 27) or water leakage.

### 3 Check that the drain cock has been closed and no water remains in the drain tank. (If the drain cock is open, close it. If water remains in the drain tank, discharge the water.)

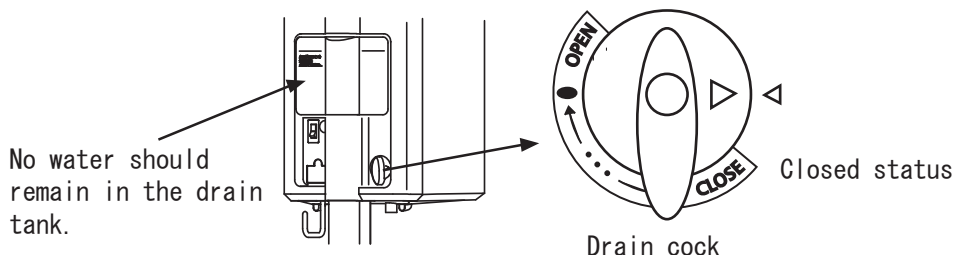

Be sure to install the drain tank. Ignoring this precaution may allow the mist or water to enter the machine, thus resulting in machine failure, short circuit, electric shock hazard, etc.

### 4 Insert the water-supply bottle into the water-supply bottle pan.

※ Align the  $\Delta$  mark on the main unit with the  $\Delta$  mark on the water-supply bottle.  
When you use the bottle for the first time, air will enter the bottle with a gurgling sound, which is not a failure.

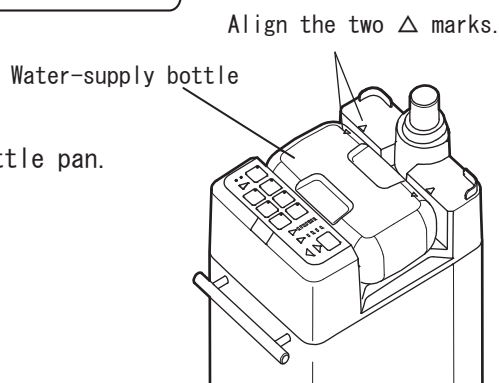

# Operation Procedures (For cases other than the cap practice, also see the method for using the appropriate option.)

## 1 Insert the flexible hose into the exhaust nozzle.

Insert the flexible hose into the exhaust nozzle of the main unit.

※ When you have the optional Flexible hose holder, set the holder on the flexible hose in advance by referring to the procedures shown on page 25.

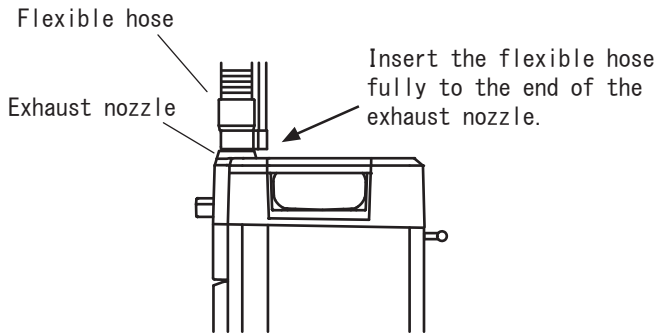
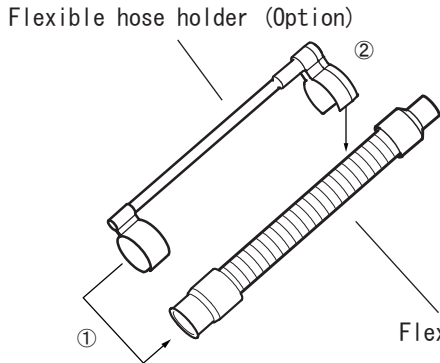

※ The optional Flexible hose holder will be used for head spa, treatment, color, or perm using the styling chair or the men's chair.

## 2 Set the main unit behind the customer.

As illustrated at the right, set the main unit so that the flexible hose side (exhaust nozzle side) can be positioned closer to the customer.

**CAUTION**

- Be careful about interference with other equipment. Ignoring this precaution may damage other equipment or cause physical injury.

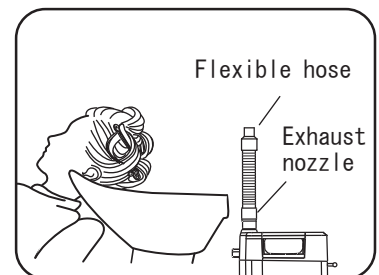
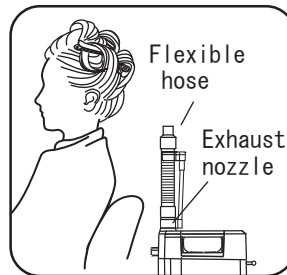

Setup State (Styling chair)

Setup State (Shampoo bowl)

**CAUTION**

- When the product is moved and the flexible hose or the exhaust nozzle located at the root of the hose is held, the nozzle may be damaged, resulting in machine failure. In order to move the product, be sure to hold the handle behind the main unit (See "Name of Each Part" on page 4).
- Do not move the product or expose it to vibrations while the product is in operation. Ignoring this precaution may cause abnormal operation of the machine.

## 3 Turn on the power.

Connect the power plug to the wall outlet. → Turn on the power switch.

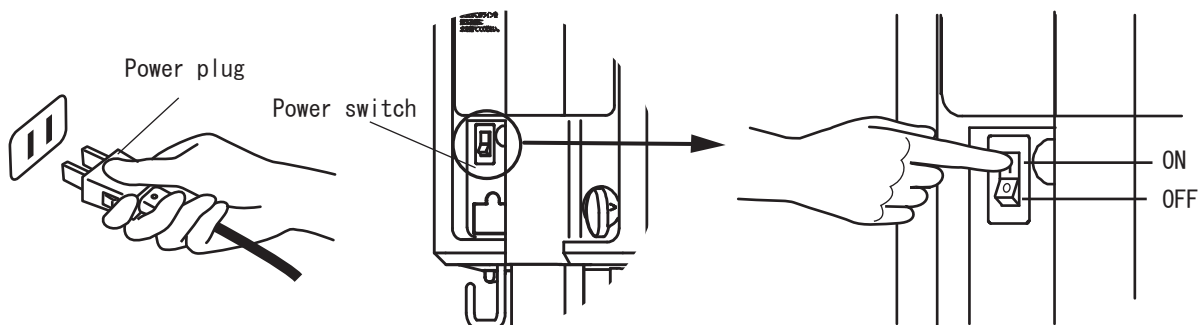

※ When the power is turned on, all lamps on the control panel will illuminate (for two seconds). Then, the lamp for the mode selection key will blink to indicate the mode selection standby state. At the same time, the operation to keep the water in the machine warm (heat-retaining mode) to prepare for the subsequent operation will be implemented.

# Operation Procedures (For cases other than the cap practice, also see the method for using the appropriate option.)

## 3 Press the key for the desired mode.

Choose the desired mode out of the six modes provided on the control panel and press the key. The default setup for the selected mode will be indicated on the control panel.

※ To change the setups for the modes, refer to "Change and Memorization of Setups" on page 9.



Do not press the keys on the control panel with hard or pointed objects.

※ When a mode is selected, the lamp for the Start/Stop key will start to blink.

## 4 Press the Start/Stop key to implement preheating.

This action will warm the water in the machine to the specified temperature to put the machine in the operation start standby status.

### Information

- The **PH** and **10** (preset time) indications will blink alternately on the display panel, and the temperature level lamp and the mist level lamp will also blink.
- Upon completion of the memorization, short electronic beeping sounds will indicate that the setting has been saved. In addition, the state indication lamp and the start/stop key lamp will also start to blink, and the machine will go into operation standby status. (After 10 minutes, the operation standby status will be cancelled, and the status will be restored to the heat-retention status.)
- When the start/stop key is pressed during the preheating phase, preheating will be cancelled. (The status is restored to the heat-retention status.)
- You can change the setup during the preheating phase. However, preheating will be terminated when the temperature level is set to "0" and the status is put in the operation standby status. When the temperature level is changed to a level from "0," the operation standby status is cancelled to initiate the preheating operation.



### CAUTION

When a change is made to the temperature level during preheating (while PH is blinking) and Temperature Level 0 is indicated once (the change is made to a different level via Temperature Level 0), the mist with low temperature will be atomized. Therefore, the control unit judged the situation as failure of the temperature detector, and the E2 indication may be issued later. In addition, the same can be applied to the case where the temperature level is increased during operation at Temperature Level 0. Therefore, the operations as stated above should not be executed. Note that the E2 indication in this case does not mean a failure. Turn off the power switch once and then execute the operation again with the correct operation procedures.

<Operation example where E2 indication may be issued>

Change from Temperature Level 5 to 2 during preheating  
 Temperature level 5 → 6 → 7 → 0 → 1 → 2  
 (Generation of mist)

Change from Temperature Level 0 (during operation) to 4  
 Temperature level 0 → 1 → 2 → 3 → 4

While preheating is in progress,

your work can be more efficient by setting the mist cap on the customer (for cap practice).

- ① Set the mist cap.
- ② Insert the flexible hose into the cap joint N.

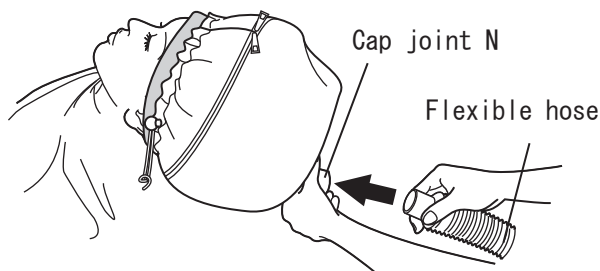

Insert the hose fully to the end.

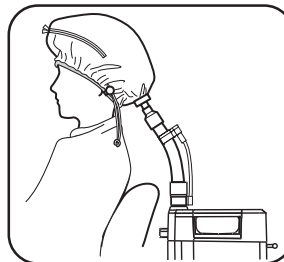

Setup State (Styling chair)

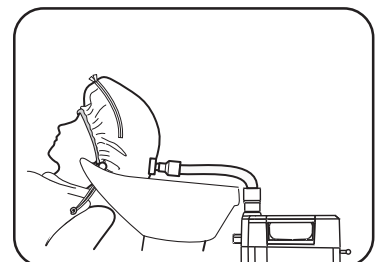

Setup State (Shampoo bowl)

※ The setup procedures for the mist cap and the connection method/direction of the flexible hose differ by the types of mist cap. See the section "Installation/Detachment of Mist Cap" described on pages 17 through 23.



### CAUTION

Use of the machine with the flexible hose bent or twisted may result in insufficient generation of mist, or machine failure or accidents caused by increased temperature.

# Operation Procedures

## 5 Press the Start/Stop key to start the operation.

When preheating is completed and the machine is in the operation standby state, press the Start/Stop key to start operation.

**Information** During operation, the state indication lamp will illuminate.

## 6 During Operation

During operation, the lamp for the Start/Stop key, the state indication lamp, and the lamp that indicates the selected mode will illuminate, and the remaining time will be indicated.



- Do not cover the open end of the flexible hose or the opening of the exhaust nozzle, and do not put any foreign matter into the hose or the nozzle. Ignoring this precaution may result in abnormal machine operation or machine failure.
- During operation, the head of the customer is heated by the mist. Should the customer feel sick, stop using the machine.

### Changing the conditions during operation

Press the key for the operation to be changed.

- 1 Operation time
- 2 Mist temperature
- 3 Mist quantity
- 4 Mode
- 5 Sound volume

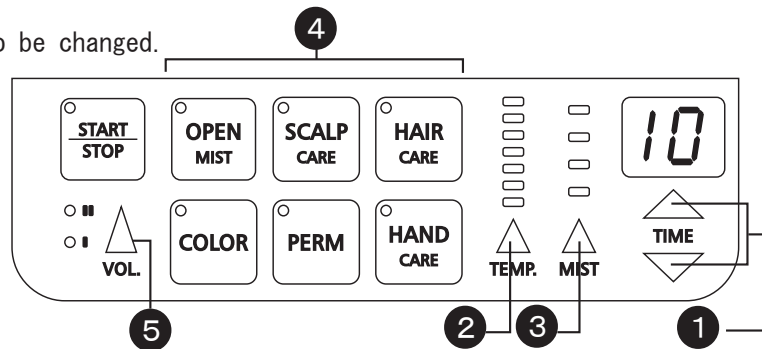

**Information** When the mode is changed during operation (the perm mode and the color mode cannot be changed), the machine operation stops and the standard setup of the mode after the change will be indicated. (The operation state is restored to the heat-retaining state.)

### Stopping the operation

When the user wants to stop machine operation, press the Start/Stop key.

**Information** While the machine is stopped, the lamp for the Start/Stop key and the indication of the remaining time will blink. (When ten minutes elapses in this state, the operation state is restored to the heat-retaining state.)

### Changing the conditions while the machine is stopped

Press the key for the operation to be changed.

- 1 Operation time
- 2 Mist temperature
- 3 Mist quantity
- 4 Mode
- 5 Sound volume

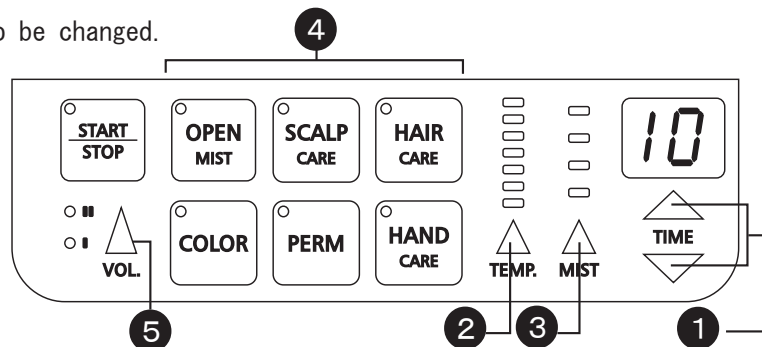

### Resuming the operation

To resume machine operation, press the Start/Stop key.

# Operation Procedures

## 7 Cooling (Only for the hair care mode and the color mode)

When the preset time has elapsed, an electronic alarm sound (two blips) is initiated, and the machine enters the cooling process.

(In modes other than the hair care and color modes, no cooling operation is provided, and the machine is put in the time-up state.)

※During the cooling operation, the letter "C" and the remaining time will be indicated on the display panel.

The cooling time can be changed by using the time setup key.

The cooling operation can be stopped with the Start/Stop key.

When the cooling operation is completed, an electronic alarm sound (three blips with a longer third sound) is initiated, and the machine is put in the time-up state.

## 8 Time-up

When the preset time has elapsed (the time indication shows 0), the machine operation will stop, an electronic alarm sound (three blips with a longer third sound) is initiated, and the machine is put in the time-up state.

※During the time-up state, the laps time after the stop of the machine operation will be indicated on the display panel.

With the time-up state, press the  $\Delta$  key of the time setup key and press the Start/Stop key. Then, extended operation will be initiated with the original setup. (The extension time can randomly be changed with the time setup key.)

A press on the mode key under the time-up state will put the machine into the heat-retention state.

## 9 Turn off the power after finishing the work.

Turn off the power switch provided at the front panel of the main unit.

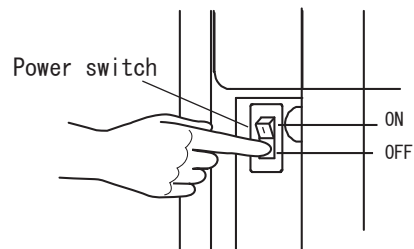

## 10 Clear out the water accumulated in the drain tank.

Detach the drain tank located at the front part of the main unit, and clear out the water accumulated in the tank.

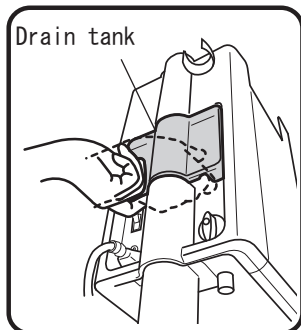

**1** Firmly hold the drain tank at both ends.

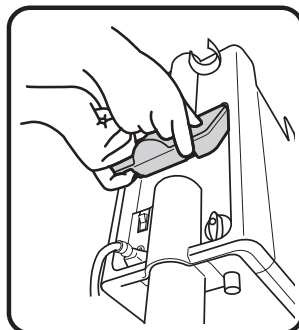

**2** Pull the tank to your side, while firmly holding the tank.

On the drain tank, there is a hole for preventing the overflowed water from entering the machine.

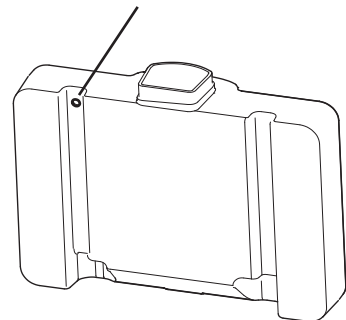

※To mount the drain tank, do the same procedures in reverse order.



Clear out the water before it reaches the indicated line on the drain tank. When the water is not cleared out, the water will overflow from the drain tank, which may result in machine failure, electric shock hazard, etc.



# Operation Procedures

## 11 Drain the inside water when closing the work.

Put a washbowl or the like beneath the drain outlet, and open the drain cock to drain the water. Upon completion of draining, close the drain cock.

※To use the machine always in a sanitary condition, be sure to drain the water every day when closing the work. Draining the water every day can significantly reduce the generation of scale that may cause machine failure.

※When draining the water, keep the water-supply bottle inserted in the main unit. This will also keep the inside of the main unit clean.

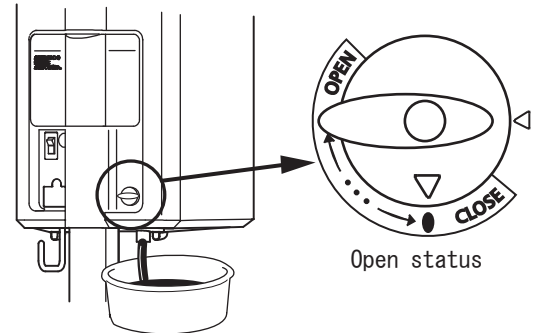

- Drain the water after the machine has sufficiently cooled. The machine is hot during operation or right after operation, and there is a possibility of machine breakage or physical injuries.
- When draining the water, do not put your hands, feet, etc., close to the drain outlet. Hot water may come out of the outlet, and there is a possibility of burns or physical injuries.
- When the room temperature decreases to 0° C or below, the inside water will be frozen, which will cause the machine to become inoperable. Be sure to drain the water.
- If you forget to close the drain cock, water overflows from the drain outlet when water is fed. Be sure to close the drain cock.

## 12 Accommodating the flexible hose

As shown in the illustration below, the flexible hose can be temporarily accommodated in the hose holder.

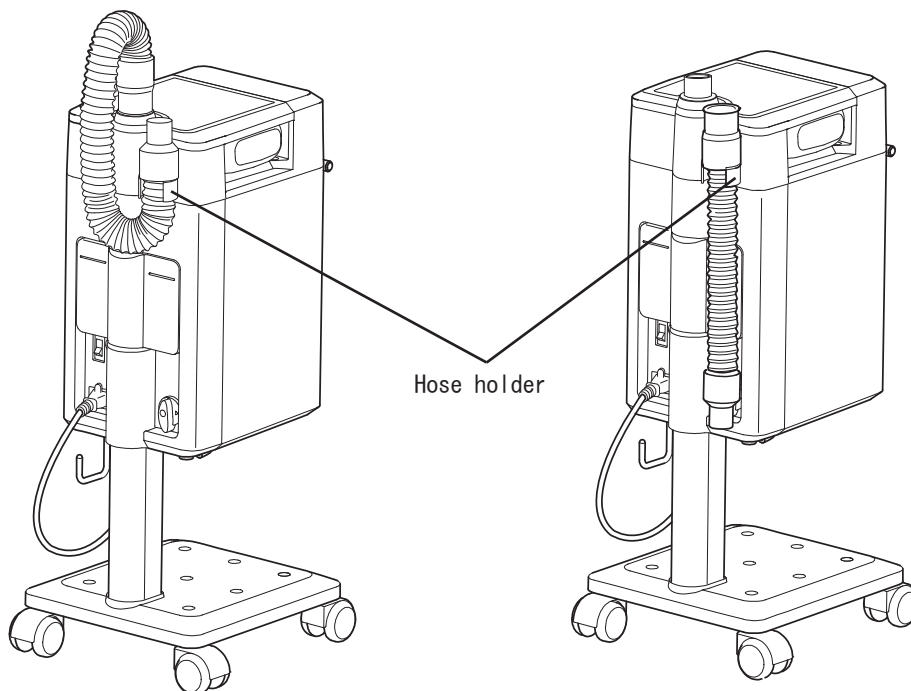

Be sure to clean out the water remaining in the flexible hose. Ignoring this precaution may cause bad odors from the remaining water or deterioration of the flexible hose.

# Installing/Detaching the Mist cap

## 1 Practice using the shampoo bowl

※The customers who have the optional Open Mist Ball Nozzle are requested to see the description on page 23.

Use either of the following:

The mist cap for YUME and open mist ball nozzle (EA-CMC-YB); or

The mist cap for rear shampoo and YUME (EA-SMC-RSW), according to the bowl you use.

## Installing the mist cap

- 1 Lift the head of the customer, and overlap the turban with the mist cap, and set it under the head.



- 2 While pulling the turban at both ends, attach it to the forehead, and put the hook and loop fasteners together.

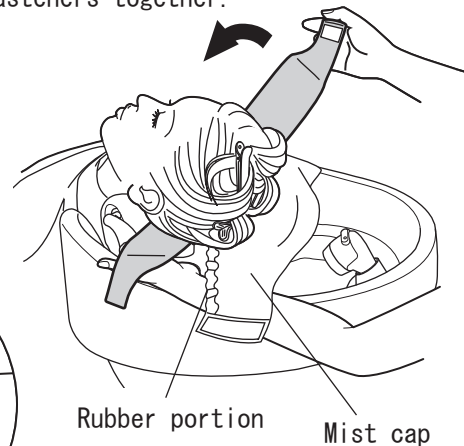

Turban

At this time, align the center part of the turban with the rubber portion of the mist cap and overlap them.

- 3 While lapping the rubber portion of the mist cap with the turban, put the hook and loop fastener at the right and left ends together.

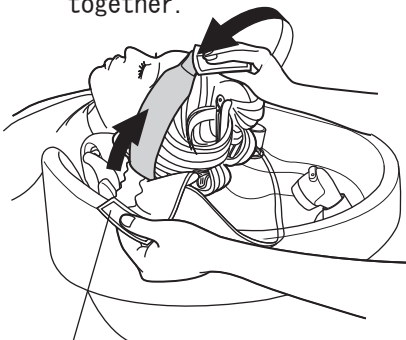

Hook and loop fastener

- 4 Adjust and fix the right and the left fasteners, one at a time.

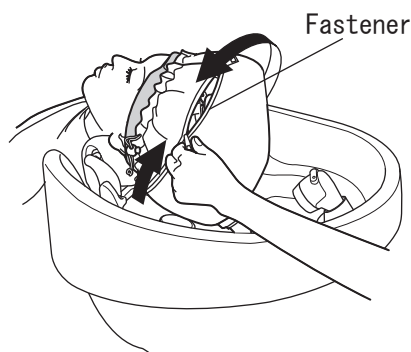

- 5 While pressing the stopper, pull the string tight and fix the stopper.

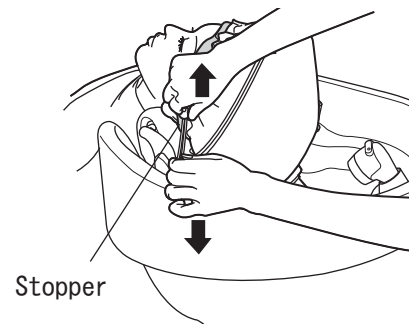

### Information

To prevent mist leakage, be sure to overlap the turban with the mist cap tightly, and secure the hook and loop fasteners without allowing any gaps.



CAUTION

Be careful not to jam the customer's hair into the fastener.

### Information

To prevent mist leakage, be sure to pull the string tight.

- 6 Insert the leading edge of the flexible hose into the cap joint N. At this time, be careful not to twist the mist cap, and insert the flexible hose with the [UP] mark of the inner cap joint N facing UP. (See the section "Preparation" on page 10.)

※If the flexible hose is hard to insert, apply water to the inside of the plug-in portion of the flexible hose, which will make your work easier.

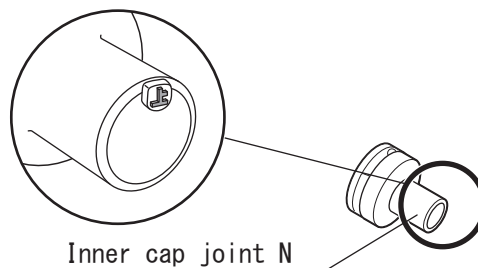
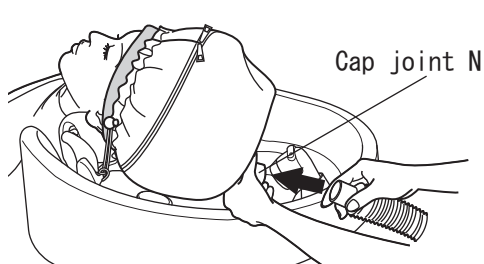

Do not use the machine with the mist cap crushed by the flexible hose. Ignoring this precaution may result in mist that will not be atomized correctly, the customer will feel sick, or the customer will get burned.

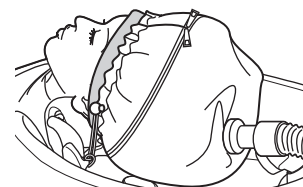

- 7 This completes the installation of the mist cap.

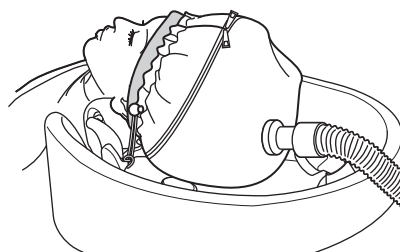

## Detaching the mist cap

- 1 Pull off the leading edge of the flexible hose from the cap joint N.

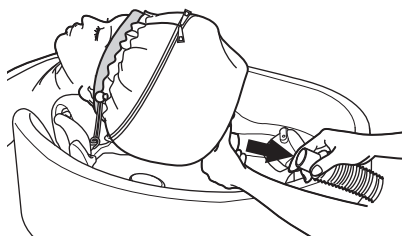

- 2 Release the stopper and loosen the strip.

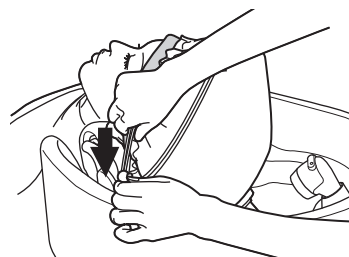

**Information** Water drops accumulate in the mist cap. Be careful about water dripping from the cap.

- 3 Unfasten the hook and loop fasteners of the mist cap and the turban.

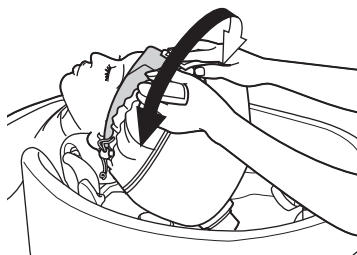

- 4 Raise the customer's head, and remove the mist cap and the turban.



- Be sure to drain the water in the flexible hose into the bowl after use.
- Be careful not to bend or twist the flexible hose.
- Use of the machine without draining the water in the flexible hose or with the hose bent or twisted may make it difficult to atomize the mist or may result in machine failure or accidents due to increased temperatures.



Be sure to drain the accumulated water after each operation.

# Installing/Detaching the Mist Cap

## 1 Practice using the styling chair

Use the mist caps (EA-SMC-SW, PC, PCB, PCS) for the styling chair and perm/color.

Installing the mist cap. (Use of the optional Flexible hose holder is recommended.)

1 Apply the turban by using either method of A or B shown below.

(A) < Method for fixing the hook and loop fasteners on the forehead >

Position the center of the turban at the back center of the customer's neck, and secure the tape onto the forehead.

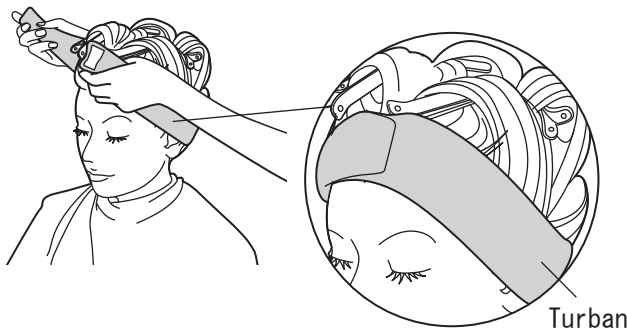

(B) < Method for fixing the hook and loop fastener at the neckline. >

Set the center of the turban on the forehead, and secure the hook and loop fasteners so that the turban comes down to the lowest neckline of the customer.

\* If you are concerned about mist leakage, Method (B) is recommended.

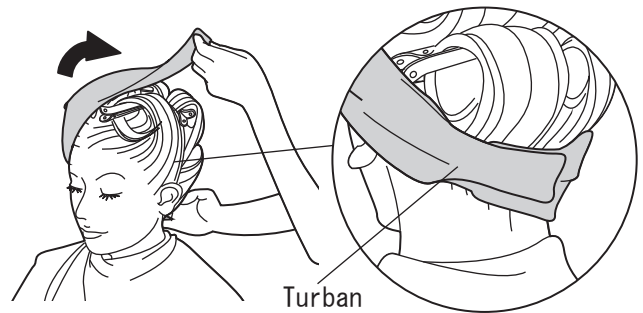

2 Open the fastener of the mist cap, overlap the rubber portion on the turban, and then mate the right and the left hook and loop fasteners of the mist cap on the forehead.

First, mate the center of the mist cap and the back center of the turban.

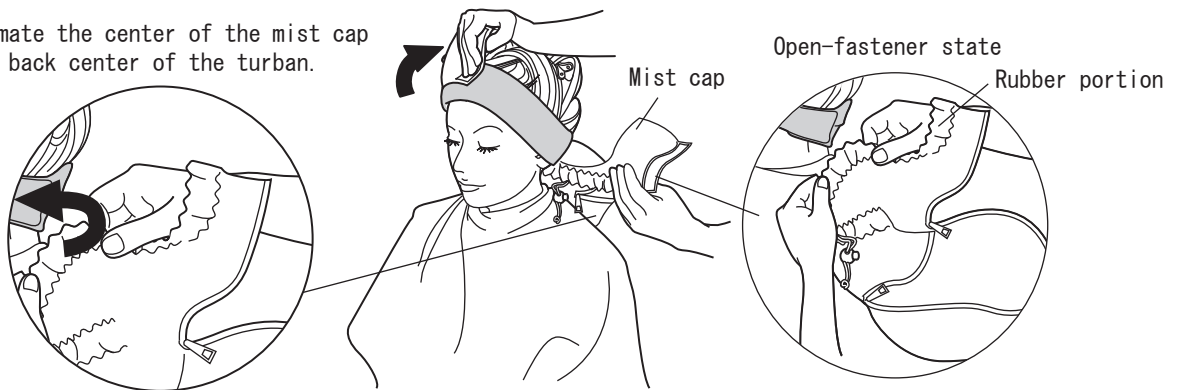

### Information

To prevent mist leakage, be sure to overlap the turban with the mist cap tightly, and secure the hook and loop fasteners without allowing any gaps.

3 Pull and tighten the string and secure it with the stopper.

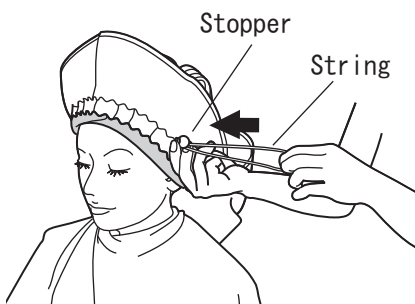

4 Tighten the fasteners at the right and the left sides, one at a time.



5 Insert the leading edge of the flexible hose into the cap joint N.



### Information

To prevent mist leakage, be sure to pull and tighten the string.



CAUTION

Be careful not to allow the customer's hair to be jammed into the fasteners.

※ If the flexible hose is hard to insert, apply water to the inside of the plug-in portion of the flexible hose, which will make your work easier.

- 6 This completes the installation of the mist cap. At this time, insert the flexible hose with the [UP] mark on the inner cap joint N facing [UP], while paying attention not to twist the mist cap. (See the section "Preparation" on page 10.)

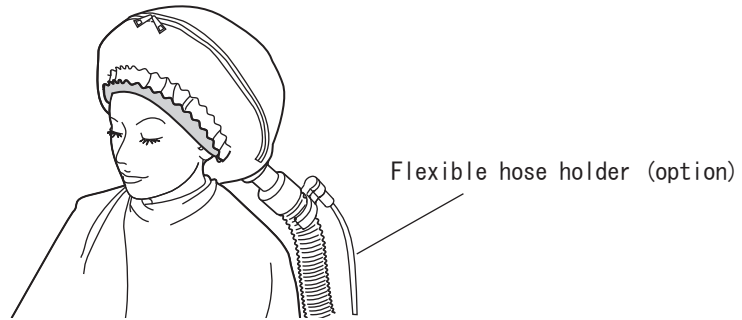

## Detaching the Mist Cap

- 1 Release the stopper, and loosen the string.
- 2 Detach the hook and loop fasteners, and then remove the mist cap.



### Information

Pay attention to dripping when removing the mist cap, since water drops are accumulated in the mist cap.

- 3 Wipe off the water accumulated in the mist cap with a towel or the like. Drain the water in the flexible hose, and then detach the cap from the flexible hose.

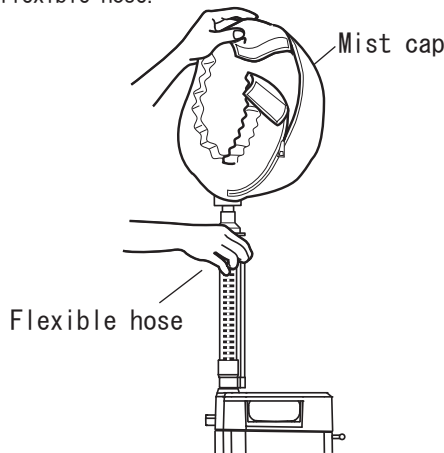

- 4 Detach the turban.



### Information

Detaching the mist cap without draining the water may cause dripping. The water returned into the flexible hose will enter the drain tank provided at the front of the main unit. Discharge the water accumulated in the tank before the water level exceeds the indicated line on the drain tank.



- Be sure to drain the water accumulated in the flexible hose after use.
- Be careful not to bend or twist the flexible hose.
- Use of the machine without draining the water accumulated in the flexible hose or with the hose bent or twisted may make it difficult to atomize the mist or may result in machine failure or accidents due to increased temperatures.



Be sure to drain the accumulated water after each operation.

# Installing/Detaching the Mist Cap

## 1 Practice using CALME, men's chair

Use the mist cap for CALME, men's chair (EA-SMC-CA).

### Installing the mist cap

- 1 Recline the backrest of CALME for an adequate angle. (Swing Button)  
Lift the head of the customer, and set the pillow beneath the neck.



At this time, adjust the pillow position to allow a gap of about 5 cm (thickness of two palms) between the backrest and the back of the head.

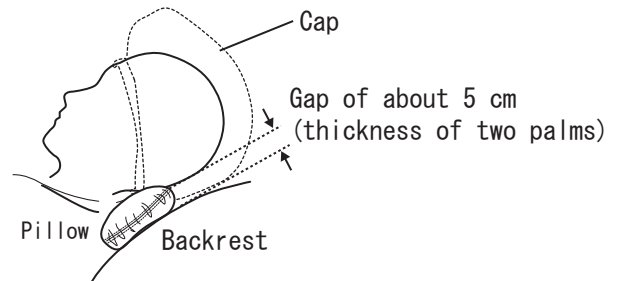

#### Information

- Without allowing an adequate gap between the backrest and the back of the head, the mist will not reach throughout the head.
- Even when the practice is done from the state where the mist cap is already installed on the head, the pillow should be set as shown above.
- Even when a towel or the like is used instead of a pillow, it should be set so that a gap of about 5 cm is ensured as stated above.

- 2 Lift the head of the customer, and overlap the turban with the mist cap, and set it under the head.

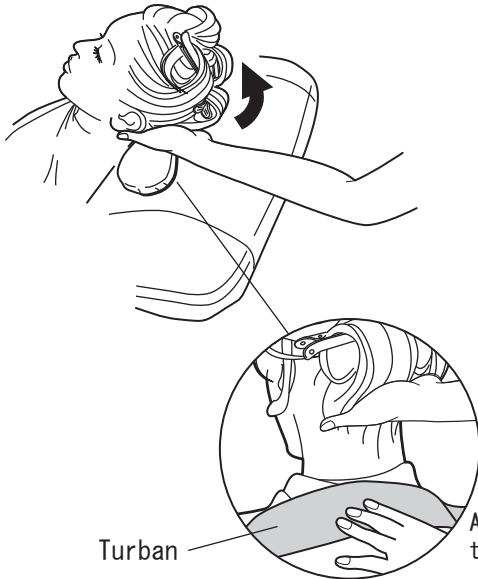

- 3 While pulling the turban at both ends, attach it to the forehead, and put the hook and loop fasteners together on the forehead.

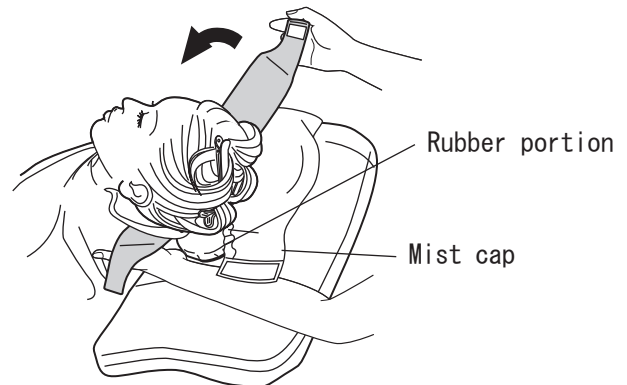

At this time, align the center part of the turban with the rubber portion of the mist cap and overlap them.

- 4 While lapping the rubber portion of the mist cap with the turban, put the hook and loop fastener at the right and left ends together on the forehead.

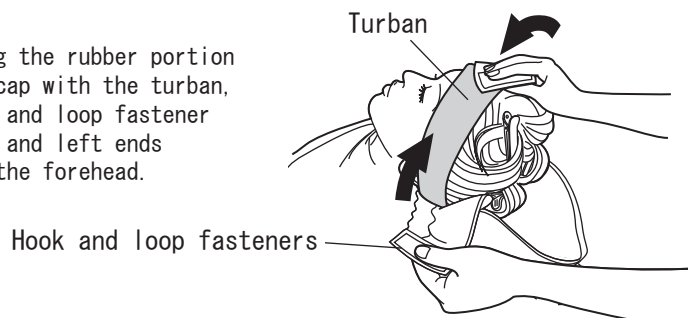

#### Information

To prevent mist leakage, be sure to overlap the turban with the mist cap tightly, and secure the hook and loop fasteners without allowing any gaps.

- 5 Adjust and secure the right and the left fasteners, one at a time.

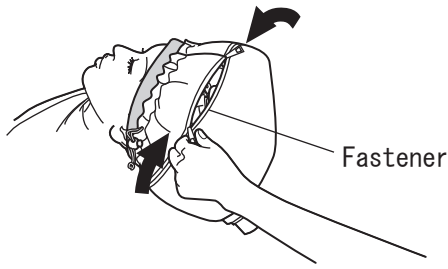

Be careful not to jam the customer's hair in the fastener.

- 6 Pull the string tight and fix the stopper.

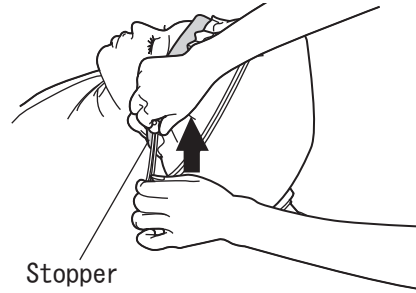

#### Information

To prevent mist leakage, be sure to pull the string tight.

- 7 Insert the leading edge of the flexible hose into the cap joint N. At this time, be careful not to twist the mist cap, and insert the flexible hose with the [UP] mark of the inner cap joint N facing [UP]. (See the section "Preparation" on page 10.)

※ If the flexible hose is hard to insert, apply water to the inside of the plug-in portion of the flexible hose, which will make your work easier.

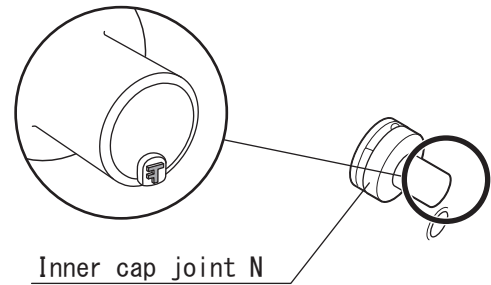
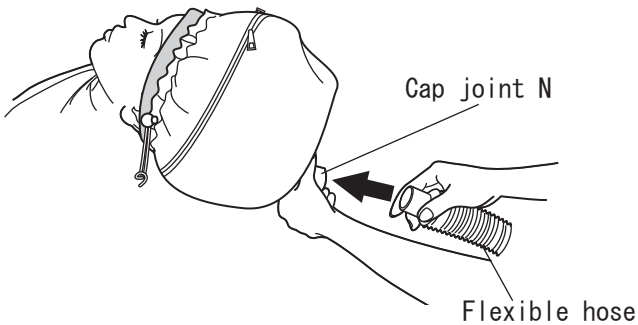

Do not use the machine with the mist cap crushed by the flexible hose. Ignoring this precaution may result in failure to atomize the mist correctly, and the customer may get burned.

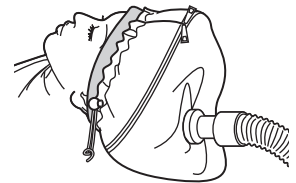

- 8 This completes the installation of the mist cap.

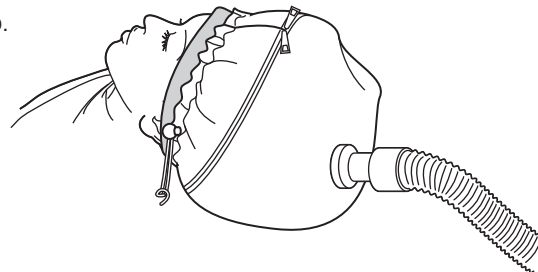

- Be sure to drain the water in the flexible hose into the bowl after use.
- Be careful not to bend or twist the flexible hose.
- Use of the machine without draining the water in the flexible hose or with the hose bent or twisted may make it hard to atomize the mist or may result in machine failure or accidents due to increased temperatures.



Be sure to drain the accumulated water after each operation.

## Detaching the Mist Cap

- 1 Release the stopper, and loosen the string.

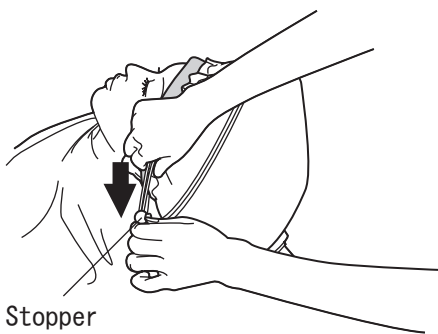

### Information

Pay attention to dripping when removing the mist cap, since water drops are accumulated in the mist cap.

- 2 Detach the hook and loop fasteners, and then remove the mist cap.

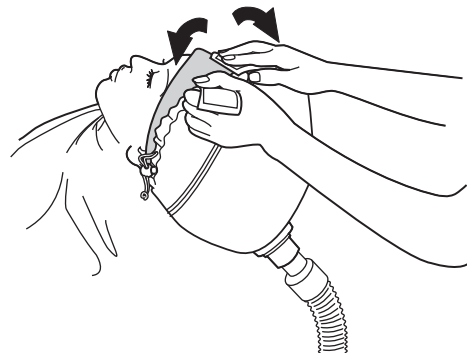

- 3 Detach the mist cap from the flexible hose after returning the water accumulated in the mist cap back into the flexible hose.

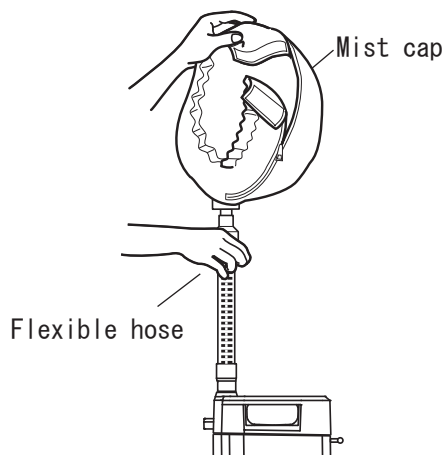

- 4 Detach the turban.

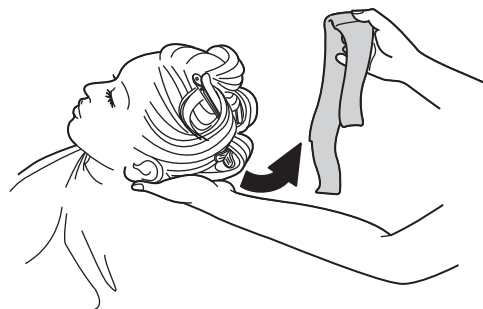

### Information

Detaching the mist cap without draining the water may cause dripping.

The water returned back into the flexible hose will enter the drain tank provided at the front of the main unit. Discharge the water accumulated in the tank before the water level exceeds the indicated line on the drain tank.



# Using the Open Mist Ball Nozzle (Option)

※Use the machine under the open mist mode.

- 1 Install the Open mist ball nozzle on the bowl by using the suction pad.

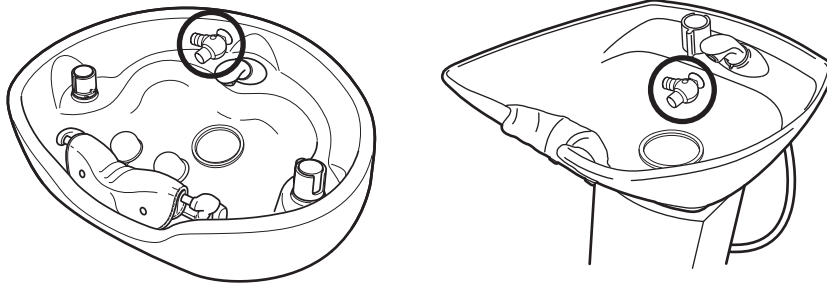

<Recommended position of YUME Series bowl> <Recommended position of RS Series bowl>

## Information

Wipe and clean the position in advance to which the Open mist ball nozzle is installed to remove wetting, etc. Ignoring this precaution may make the suction pad hard to attach.

- 2 Install the flexible hose on the Open mist ball nozzle.

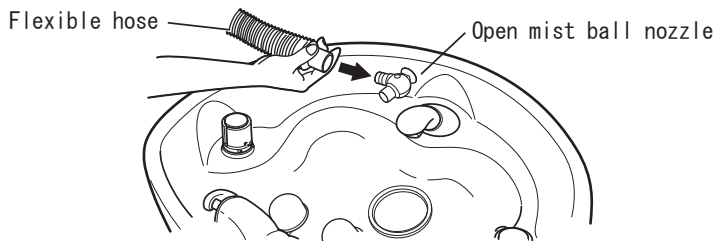

## Information

If the flexible hose is hard to insert, apply water to the inside of the flexible hose, which will make your work easier.

- 3 Adjust the nozzle (outlet of mist) in the desired direction in which the mist is atomized.

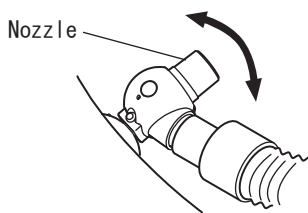

**CAUTION**

Pay attention to the positions of the nozzle and the customer's head. For the RS Series product, in particular, be careful about temperatures, since the distance to the head is closer. Decrease the temperature setting if the customer feels too warm. Stop using the machine if the customer feels sick or is in bad shape due to excessive temperatures. Ignoring this precaution may result in burns or dizziness.

## Applying the cap practice by using the Open mist ball nozzle



**CAUTION**

Do not apply the cap practice under the open mist mode.

Using the nozzle at a high-temperature level will raise the temperature in the cap, thus resulting in dizziness, burns, etc.

## Preparation

- 1 Install the cap joint N on the mist cap (See the section "Preparation" on page 10).
- 2 Insert the joint hose into the cap joint N.

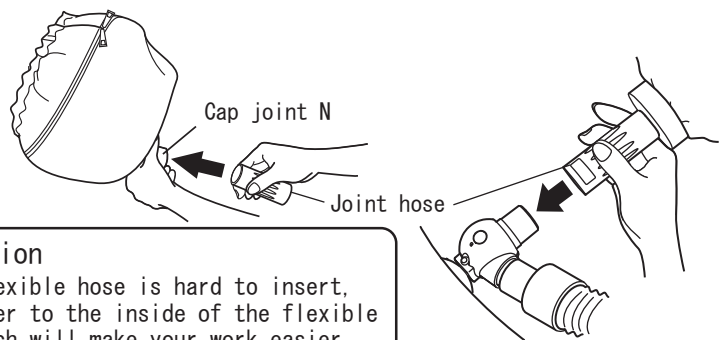

## Operating Procedure

- 1 Insert the joint hose into the nozzle

## Information

If the flexible hose is hard to insert, apply water to the inside of the flexible hose, which will make your work easier.

## Replacing the Suction Pad

- 1 Pull off the fixing pin, which is mounted on the main unit of the Open mist ball nozzle, using a bar or the like. Then, the suction pad can be removed from the main unit.

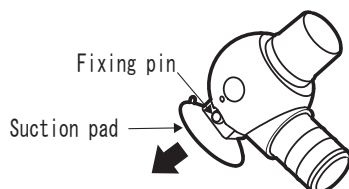

- 2 Insert the new suction pad into the Open mist ball nozzle, and press in the fixing pin to fix the pad.

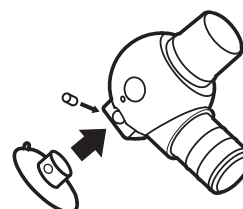

# Using the Aromatherapy Diffuser Holder (Option)

※To use the Aromatherapy Diffuser Holder, the Open mist ball nozzle (option) is necessary.  
Use the holder under the open mist mode.

## Preparation

- 1 Detach the lid of the Aromatherapy Diffuser Holder.

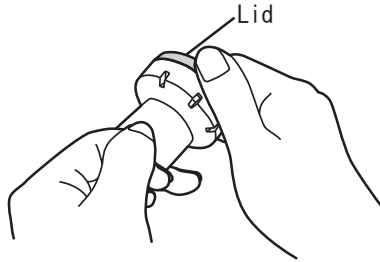

- 2 Insert the Aromatherapy diffuser pad into the lid.

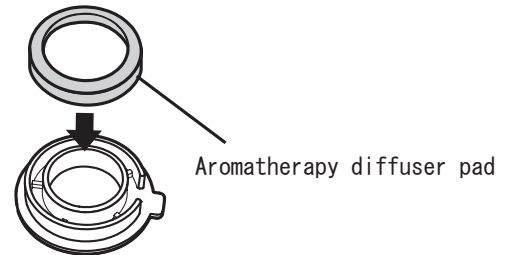

- 3 Apply several drops of aromatherapy oil on the Aromatherapy diffuser pad.



- 4 Close the lid tightly.

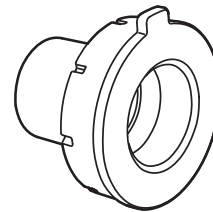

Be careful that the aromatherapy oil will not attach to places other than the Aromatherapy diffuser pad. If it does accidentally, immediately wipe it off. Ignoring this precaution will result in breakage of the machine from corrosion or cracking.

## Operation Procedure

- 1 Insert the Aromatherapy Diffuser Holder into the Open mist ball nozzle.

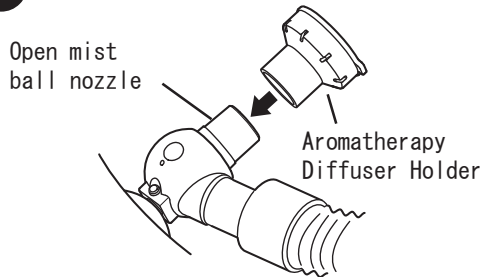

### Information

If the Aromatherapy Diffuser Holder is hard to insert, apply water to the inside of the holder, which will make your work easier.

# How to attach/detach the Flexible Hose Holder (Option)

## How to attach

- 1 Insert the rubber end of the Flexible Hose into the mouth ring of the Flexible Hose Holder.

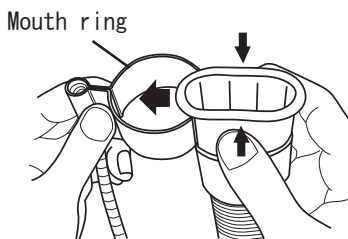

### Information

If the Flexible Hose is hard to insert, apply water to the inside of the hose, which will make your work easier.

- 2 Insert the Flexible Hose into the mist nozzle of the main unit, with the Flexible Hose Holder attached.

## How to detach

- 1 Pull out the Flexible Hose from the mist nozzle, with the Flexible Hose Holder attached.
- 2 Slant the Flexible Hose a little and pull it out from the Flexible Hose Holder.

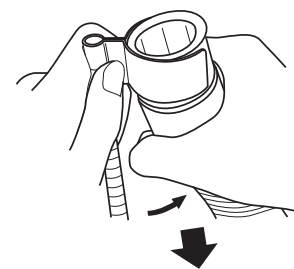

If you attach/detach the Flexible Hose Holder with the Flexible Hose already installed to the main unit, the mouth ring of the Flexible Hose Holder will get extra pressure and will stretch out and will not be able to firmly hold the Flexible Hose.

# Fixing the Machine

Before fixing the machine, be sure to disconnect the power plug from the wall outlet.

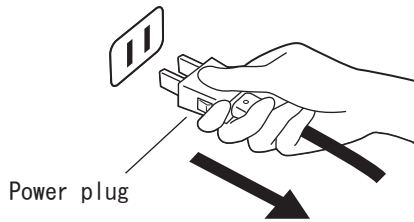

The plastic, plated, or painted parts should be cleaned with a dry soft cloth



The control panel or the metallic parts may become inoperable or rust when exposed to water. When this is the case, immediately wipe the water off with a dry soft cloth or the like.

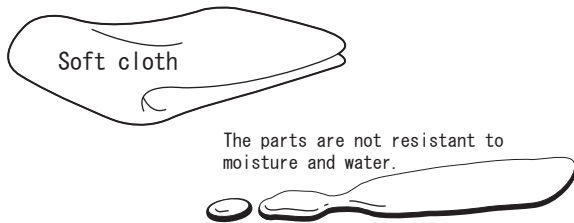

When tough stains or oil content adhere, wipe them off with a cloth that is immersed in a neutral detergent diluted with water and tightly squeezed.

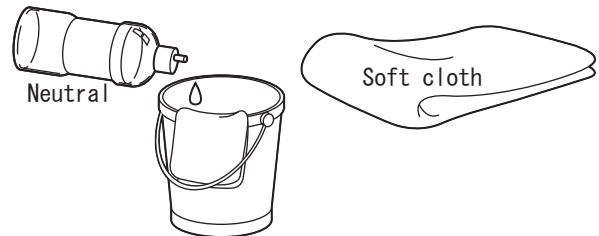

When chemical agents, such as treatment, perm, and color liquids adhere to the main unit, immediately wipe them off with a cloth that is immersed in a neutral detergent diluted with water and tightly squeezed. Leaving such chemical agents as they may cause stains or discoloration on the surfaces.

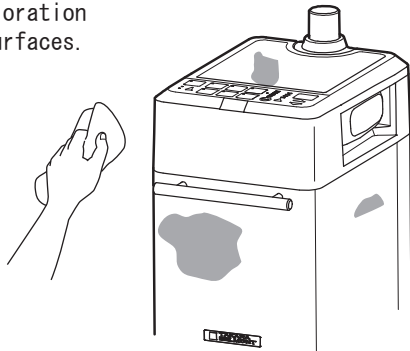

Hand wash the mist cap with a neutral detergent. In addition, if chemical agents, such as color agents adhere, immediately clean them with water. Leaving such chemical agents as they may cause stains or discoloration on the surfaces.



Never use materials such as volatile chemicals including thinner, alcohol, gasoline and kerosene oil, as well as wax, sponges, or scrubbing brushes that contain abrasive compounds. Do not clean the inside of the water-supply bottle pan, water-supply bottle, and inside of the drain tank using chemical agents.

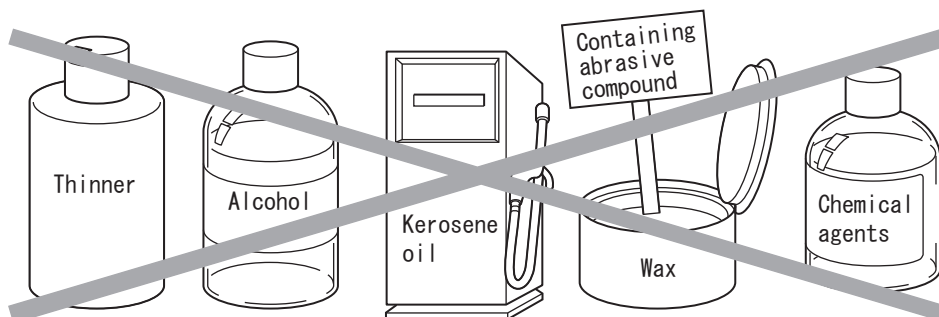

# State Indication

When an indication showing the state of the main machine unit is displayed on the display panel, take necessary measures according to the table stated below:



Indicate preheating is in process. → Wait until the machine is warmed up.



Indicate cooling is in progress and the elapsed time. → Indicate the remaining time of cooling phase.



Indicate shortage of water in the water-supply bottle. → Pour water into the water-supply bottle. Then, a press on the Start/Stop key will cancel the error.



Too much water is in the machine  
↓  
The possible causes may be that the machine wobbles or the water-supply cap is not closed tight.

- 
1. Detach the water-supply bottle and drain the water in the main unit. (See the section "Operation Procedures" on page 16.)
  2. Pour water into the water-supply bottle, and check for any abnormal states including water leakage and breakage of the water-supply bottle.
  3. When no problem is found, set the bottle on the main unit.
  4. After completing the water supply, a press on the Start/Stop key can cancel the error.



Indicates the failure of the temperature detection unit or the heater in the machine.



Indicates the failure of the temperature detection unit.



↓  
The possible causes may include slacking of the accordion hose.



Indicates failure of the water level detection unit, including failure of the float switch.

- 
1. In case the accordion hose is loose, rectify the problem.
  2. After provisionally turning off the power switch, perform the operations again.
  3. If the error is indicated again, contact the nearest dealer or our company directly.

※In the event of an error, the error state is indicated on the display panel, the state indication lamp will blink at high speed, and an electronic blip sound will be activated to indicate the state.

# Before Asking for Repairs

When the problem cannot be rectified even if an inspection is made according to the table shown below, immediately stop using the machine, turn off the power switch, disconnect the power plug, and immediately contact the nearest dealer or our company directly.

Phenomenon	Check Point	Countermeasures
The power cannot be turned on (No indication on the control panel)	Is the power plug correctly inserted into the wall outlet?	Insert the power plug firmly into the wall socket.
	Is the power switch turned on?	Set the power switch to the "ON" position.
	Is the fuse on the distribution panel or the breaker switch in the shop in the "ON" position?	Set the fuse on the distribution panel or the breaker switch to the "ON" position.
	Is the problem not rectified when the power plug is disconnected and is then inserted again?	Immediately stop using the machine, turn off the power switch, disconnect the power plug, and then immediately contact the nearest dealer or our company directly.
The power cannot be turned on though the power switch is set to the "ON" position.	Failure of the machine might be suspected.	Immediately stop using the machine, turn off the power switch, disconnect the power plug, and then immediately contact the nearest dealer or our company directly.
Mist does not come out.	 <p>When either of the previous indications blink, see the section "State Indication" on page 27.</p>	When the problem cannot be rectified even if the measures are taken, immediately stop using the machine, turn off the power switch, disconnect the power plug, and then immediately contact the nearest dealer or our company directly.
	Check that water accumulates in the flexible hose.	Discharge the water accumulated in the flexible hose.
The temperature of mist is low or high.	Check that the temperature level setting is correct.	Execute setting up of the temperature level key again.
	Check that water accumulates in the flexible hose.	Discharge the water accumulated in the flexible hose.
Mist leaks from around the mist cap.	Check that a space exists between the turban and the mist cap.	Reset the mist cap in the manner to eliminate any space.
	Check that the hook and loop fasteners of the mist cap is robustly fixed.	Reset the fastener in the manner to eliminate any space.
Water leaks from the drain outlet.	Check that the drain cock is closed.	Close the drain cock.

# Disposing of the Product

The product must be disposed according to the law of the country where the product is used.

## Consumable Supplies (Including Options)

The term "consumable supplies" implies parts that are predicted to be worn, deteriorated, changed in appearance, or broken when used. The warranty clauses for repair or replacement shall not apply to those parts, and the repair or the replacement shall be charged.

(※The degree or timing of wear, deterioration, and breakage differ depending on the environment and/or conditions at the place where customers use the product.)

In addition, customers can replace the following parts by themselves.

(In this case, the customers do not need to bear the basic charge and the technical fee, but customers are asked to bear the shipping charges separately. If you do not understand the replacement procedures, contact your nearest dealer or our company directly.)

If the product is subjected to significant wear or deterioration or should it be broken, inspection or part replacement is necessary. If this is the case, immediately contact the dealer or our company directly.

Consumable Supplies (The following parts are not warrantable and the cost will be charged.)

- Water-supply bottle    Water-supply cap    Drain tank    Flexible hose  
Cap joint N    Power cord    Caster    TAKARA deionizer    Deionizer cartridge

Optional Items

(The optional items are not warrantable and the cost will be charged.)

※Including the accessories)

- Open mist ball nozzle    Aromatherapy Diffuser Holder    Mist cap  
Flexible hose holder    Turban

## Guidance on Daily Inspection

### WARNING

Be sure to perform daily inspections according to this Guidance. Continued use of the machine without performing daily inspections may result in machine failure or accidents.

To ensure safe use of the product, the following inspections must be performed.

#### ■ Items to be inspected on a daily basis (Inspection before starting the work)

Inspection Item	Inspection Procedures	Possible hazard when the inspection revealed NG
<input type="checkbox"/> Check that there is no deformation, breakage or deterioration on the power plug and the power cord.	<p>Check before operating the product:</p> <p><input type="checkbox"/>Check that there is no deformation, breakage, or deterioration on the power plug and the power cord.</p> <p>Check during product operation:                      (The check is limited to the case where the power plug and the power cord are not deformed, broken, or deteriorated.)</p> <p><input type="checkbox"/>When the power plug or the power cord is deteriorated, it generates heat. While operating the product, give a tactile check that the power plug and the power cord are not generating heat.</p>	<p>There is a possibility of electric shock hazard or burn due to fire or electric leakage. Since the parts need to be replaced, immediately stop using the machine, turn off the power switch, disconnect the power plug, and then immediately contact the nearest dealer or our company directly.</p>
<input type="checkbox"/> Check that there is no breakage or deterioration on the exterior parts.	<p>Take a look of the entire part of product, and check that the exterior parts, etc., are not broken or deteriorated.</p>	<p>There is a possibility that the problem may result in accidents (physical injuries such as burn) since the original functions of the product are not fulfilled. Immediately turn off the power switch, disconnect the power plug, and immediately contact the nearest dealer or our company directly.</p>

# Guidance on Daily Inspection

## ■ Items to be inspected on a daily basis (Inspection before starting the work)

Inspection Item	Inspection Procedures	Possible hazard when the inspection revealed NG
<input type="checkbox"/> Check that the power switch operates correctly and the lamps on the control panel illuminate.	When operating the power switch, there shall be no problems such as jamming of the power switch. In addition, check that all lamps illuminate when the power switch is turned on.	When the product is used in the condition where the power switch is not operated correctly, there is a possibility of failures such as the power becoming disconnected unexpectedly during operation. In addition, in the condition where the lamps on the control panel do not illuminate, the product may not be used properly because the setup state cannot be confirmed. If this is the case, immediately stop using the machine, turn off the power switch, disconnect the power plug, and then immediately contact the nearest dealer or our company directly.
<input type="checkbox"/> Check that the flexible hose is broken or twisted.	Give a visual check.	Using the machine with the hose bended or twisted may make it difficult to atomize the mist and cause machine failure or accidents due to temperature increases. Be sure to restore the hose to the original shape. If it is hard to restore it to the original shape, immediately stop using the machine, turn off the power switch, disconnect the power plug, and then immediately contact the nearest dealer or our company directly.
<input type="checkbox"/> Check that there is no flaw or crack on the water-supply bottle or the drain tank.	Give a visual check.	If any flaws or cracks are noted, immediately stop using the machine, turn off the power switch, disconnect the power plug, and then immediately contact the nearest dealer or our company directly.
<input type="checkbox"/> Check that hair is not tangled on the caster.	Give a visual check.	In case hair is tangled on the caster, remove the hair by referring to the daily inspection and maintenance procedures of the caster.

## ■ Items to be inspected on a daily basis (Inspection before closing the work)

When closing the work, drain the water accumulated in the machine, and clear out the water accumulated in the drain tank. (See page 15)

# Main Specifications (Dimensions and weight are for the stand-alone type)

Model No.	AK-160				
Electrical requirements	AC110V	4.6A	AC120V	4.2A	50/60 Hz
	AC220V	2.1A	AC230V	2.2A	
	AC240V	2.1A			
Water-supply Bottle Capacity	1400mL				
Drain Tank Capacity	450mL				
Dimensions	330 (W) × 355 (D) × 750 (H) mm				
Weight	15.2kg				

※Respective specifications are subject to change without notice.



TAKARA BELMONT CORPORATION

1-1, 2-Chome, Higashi-shinsaibashi, Chuo-ku, Osaka, Japan

TEL : +81-6-6213-5945

FAX : +81-6-6212-3680

Printed in Japan