

ROLLER BALL *F*
 Model
 AK – S 2 3 A
 AK – S 2 3 A F

Operating Manual

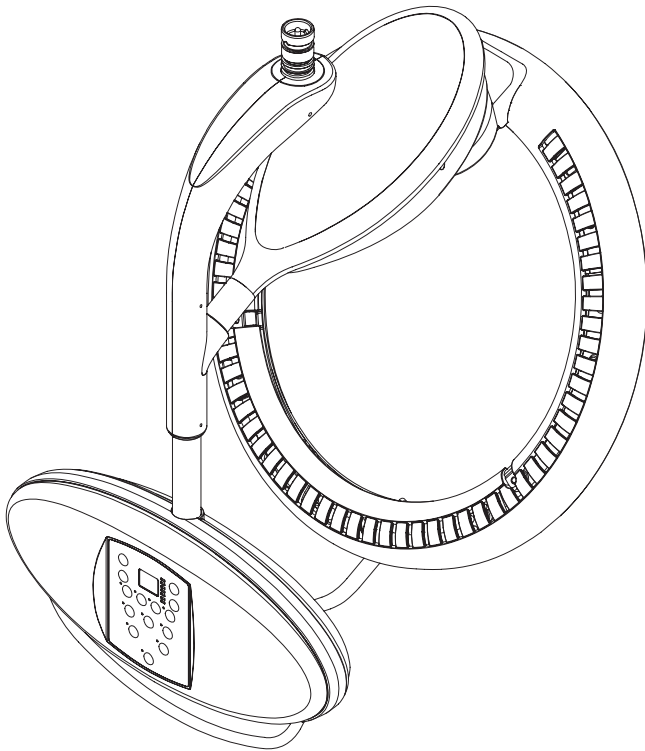

Thank you for purchasing our product. Please read through this manual and this note carefully before installing or using. These instructions provide important information for correct usage of the product to avoid personal injuries or property damages against you or your clients.

This product is intended for the exclusive use in hairdressing salons for their salon services, and must be operated or handled by the hairdressers or by their staff under supervision.

Table of Contents

- IMPORTANT SAFETY INSTRUCTIONS ... 1
- Name of Each Part 5
- Location of Warning Label 6
- Accessories 6
- Control Panel 7
- Description of Buttons and Indications ... 7
- Outline of Modes 9
- Error Codes 10
- Setting 11
- Operating Procedures 13
- Rotation and Stopping of Ring during Operation ... 15
- Partial Heating 15
- Customized Settings 16
- Lamp Indication during Operation and Inputs from Button ... 16
- Troubleshooting 17
- USER MAINTENANCE INSTRUCTION ... 19
- Daily Inspection Procedure 20
- Dimensions and Specifications 21
- Note 23

IMPORTANT SAFETY INSTRUCTIONS

When using electrical appliances, especially when children are present, basic safety precautions should always be followed, including the following:

Before Using the Product

Carefully read through the Safety Precautions and use the product correctly. Furthermore, to use the product safely, be sure to perform the daily inspection following the procedures described in the Guidance on Daily Inspection (page 22). In case the product is continually used without performing daily inspections, product failures or accidents may occur.

Precautions stated here are for the purpose of the following:

Ensuring safe use of the product and preventing harm and damage to yourself and other persons.

Each of the precautions identifies an important item concerning safety. Be sure to observe the instructions.

We are not responsible for injuries and damage to the user and other persons should an accident occur due to failure to comply with these precautions. If this is the case, the persons who use the product without observing the safety precautions will bear responsible for the injuries and damage.

The following section provides detailed explanations of the precautions. Fully understand the meaning before reading the body text.



DANGER

This mark warns the user that “ignorance of this display and improper use may result in critical risks of death or serious personal injury”.



WARNING

This mark warns the user that “ignorance of this display and improper use may cause death or serious personal injury”.



CAUTION

This mark warns the user that “ignorance of this display and improper use may cause slight to moderate personal injury or property damage”.



Indicates the general prohibited behaviors.



Indicates the prohibition of water splashing and use near water.



Indicates the prohibition of disassembly, repair, or modification.



Indicates the need for paying attention to electrical shock.



Indicates enforcement or instructions for general user behavior.



Indicates the need for paying attention to high temperatures.



Indicates the need for paying attention to bursting of parts.



WARNING

Never touch the inside of the main unit.



Never touch the inside of the product. There is a possibility of electrical shock.
For maintenance and service of the product, be sure to contact the nearest dealer or Takara Belmont directly.

IMPORTANT SAFETY INSTRUCTIONS

READ ALL INSTRUCTIONS BEFORE USING. KEEP AWAY FROM WATER.

DANGER

Do not water the equipment.



Do not place or store appliance where it can fall or be pulled into a tub or sink. Do not use while bathing. Do not place in or drop into water or other liquid. Do not reach for an appliance that has fallen into water. Unplug immediately.

WARNING

To reduce the risk of burns, electrocution, fire, or injury to persons:

Be sure to execute the daily check.



Execute the daily check according to the Guidelines for Daily Inspection described in this manual (page 20). Improper use or operation of the equipment may result in injuries or accidents including burns.

Never disassemble or repair the equipment by yourself.



Persons other than the repair engineer must not disassemble, repair, or modify the equipment. Neglecting this warning may cause ignition or abnormal operation resulting in physical injuries.

Do not suspend from a shaft or a stand.



Do not go up or suspend from the shaft or the stand of the Roller Ball. Neglecting this caution may cause falling, tumbling, or breakage of equipment resulting in injuries.



Do not hang from the equipment or the dryer arm.



Do not suspend anything from the equipment or the dryer arm. Failure to heed this warning may lead to falling of the equipment due to damage resulting in burns or physical injury.

Shocks to the equipment in operation.



Do not expose the equipment to shocks or impacts during operation. Neglecting this warning may result in falling of the equipment, thus causing electric shock, fire, breakage, or injuries.

Do not allow the hair or the skin of the customer to contact the heater guard.



Be careful to avoid allowing the hair or the skin of the customer to contact the heater guard while the customer dozes during operation or after using the Roller Ball. Neglecting this warning may result in a burn injury.



Never drop or insert any object into any opening.



Do not insert a metal object, such as a pin or obstructions, into the ring to remove dust accumulated in the slit, etc., when fixing the Roller Ball. Neglecting this warning may result in an electrical shock or ignition caused by an electrical short circuit.

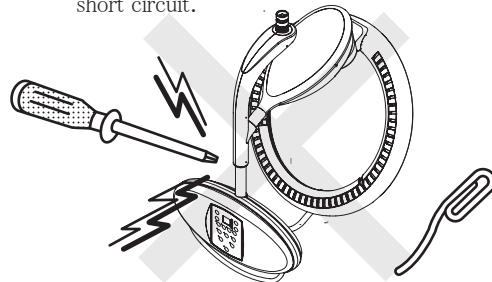

IMPORTANT SAFETY INSTRUCTIONS



WARNING

Close supervision is necessary.



Close supervision is necessary when appliance is in use.

Do not use attachments not recommended by the manufacturer.



Use this appliance only for its intended purpose and use as described in this manual. Do not use attachments not recommended by the manufacturer.

Do not allow a child to touch the Roller Ball.



Do not allow a child to touch the Roller Ball. Neglecting this caution may cause falling, deformation, or breakage of the Roller Ball resulting in a burn injury.

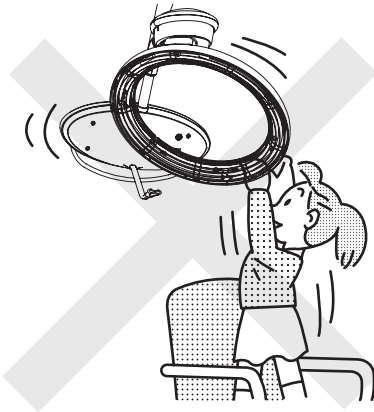

For Dryer arm, model AY-DRASN only.



Use only the dryer arm, model AY-DRASN, for this accelerator.

Do not touch hot surfaces of the products.



Do not touch hot surfaces of the products. Use the grip.

Do not use outdoors.



Do not use outdoors or operate where aerosol (spray) products are being used.

Never block the air openings.



Never block the air openings of the products or place it on a soft surface, such as a bed or couch, where the air openings may be blocked. Keep the air openings free of lint, hair, and obstructions.



CAUTION

Do not move the product while holding it at the ring or the guide bar.









Do not move the product while holding it at the ring or the guide bar. Neglecting this caution may cause tumbling, deformation, or breakage of the product resulting in physical injuries. Only move the product by holding it at the grip.



IMPORTANT SAFETY INSTRUCTIONS

CAUTION

<p>Pay attention to the surrounding area when moving the product.</p> <p> When the product is moved, the dryer arm will also move as the product moves. Pay careful attention to the furniture or personnel around the product.</p>	<p>Think of the physical condition of the customer.</p> <p> The head of the customer will become warm due to the heat from the heater during operation. If the customer experiences discomfort or feels sick, stop using the product. Particular attention should be given to those who are likely to feel dizzy, have high blood pressure, or are being treated by a doctor and there is concern about the physical condition.</p>
<p>Use the polyethylene cap.</p> <p> For the practice using the dual-step tepid permanent wave agent or the color agent, use the regular polyethylene cap. Since the polyethylene cap can transmit infrared rays, the infrared temperature sensor can correctly measure the hair temperature, thereby enabling correct temperature control.</p>	<p>Do not use the product with the perming agents designated for use under normal temperatures.</p> <p> Do not use the product with cold double-process perming agents. Neglecting this caution may cause skin disorders including a rash.</p> <div data-bbox="1011 860 1219 1055" style="text-align: center;">  <p>Agent 1 Agent 2</p> </div>
<p>Do not expose the ring to shocks.</p> <p> Do not expose the ring to shocks. Neglecting this warning may result in bursting of the heater. Pay careful attention to the handling of the product.</p>	<p>Do not allow the chemicals to adhere to the heater.</p> <p> Use the product while paying attention not to allow the chemicals to adhere to the heater. Neglecting this caution may result in breakage of the heater due to deterioration.</p>

SAVE THESE INSTRUCTIONS

Name of Each Part

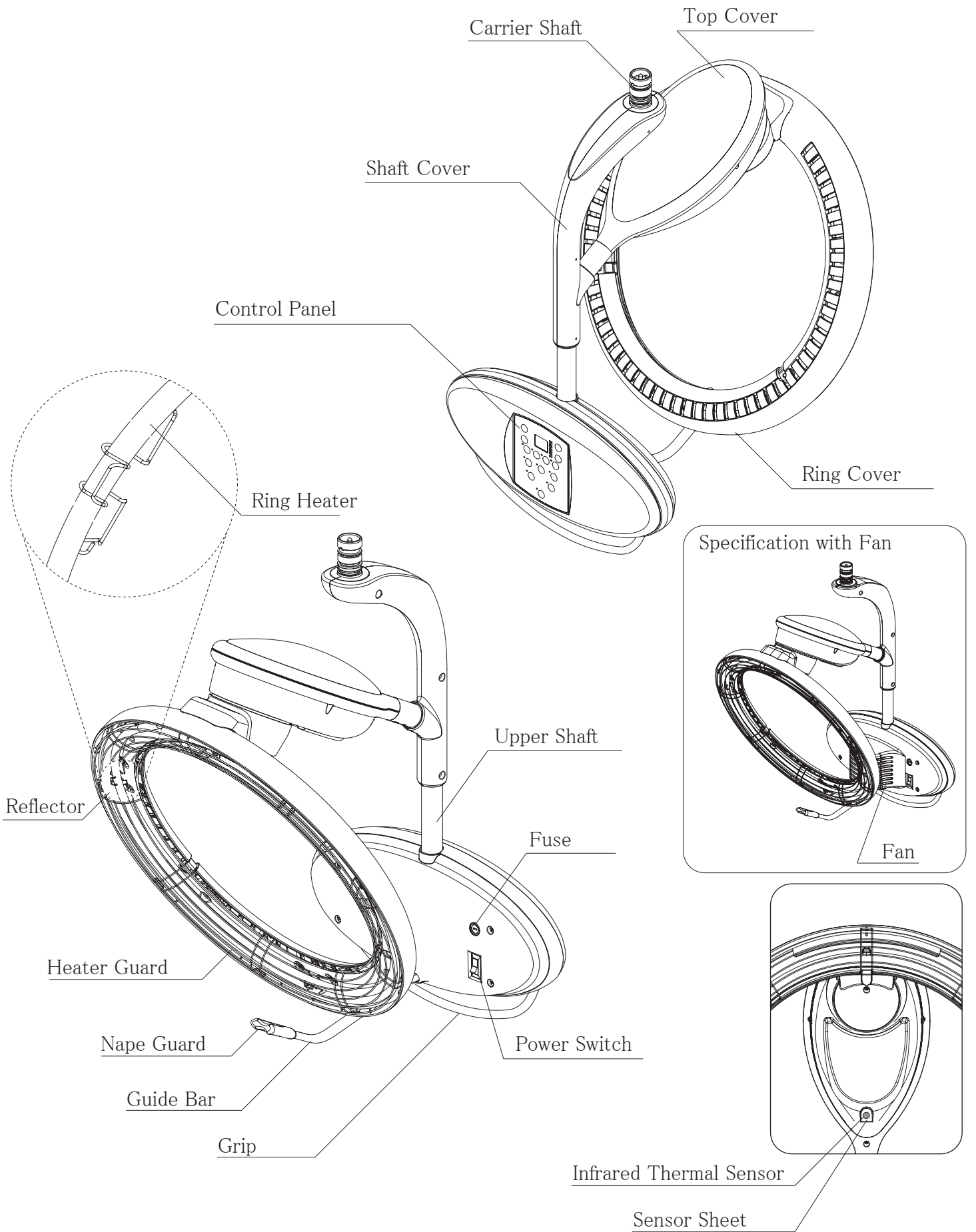

Location of Warning Label

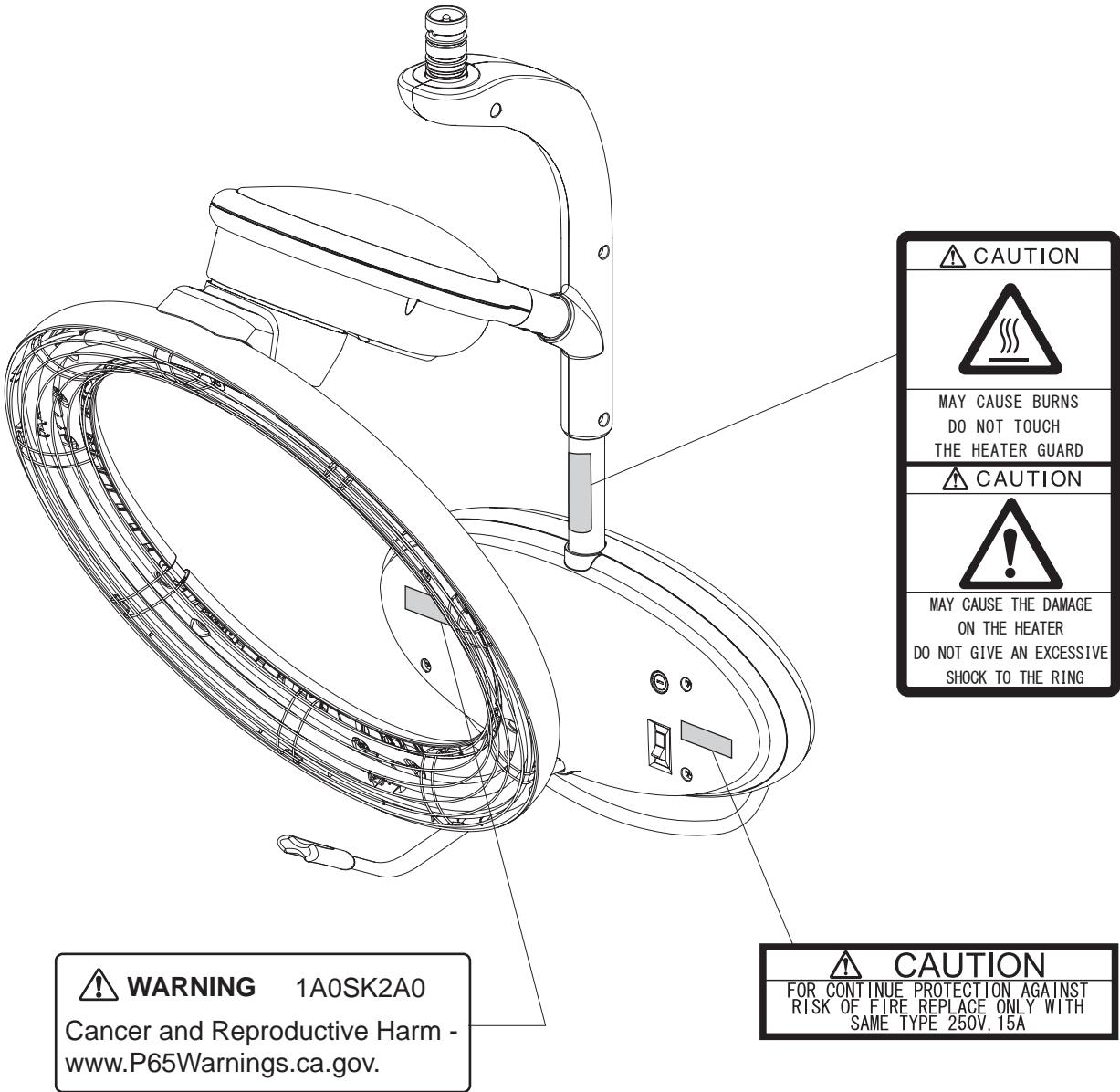

⚠ WARNING **California Proposition 65**
Cancer and Reproductive Harm - www.P65Warnings.ca.gov.

Accessories



Operating Manual: 1 copy

Control Panel

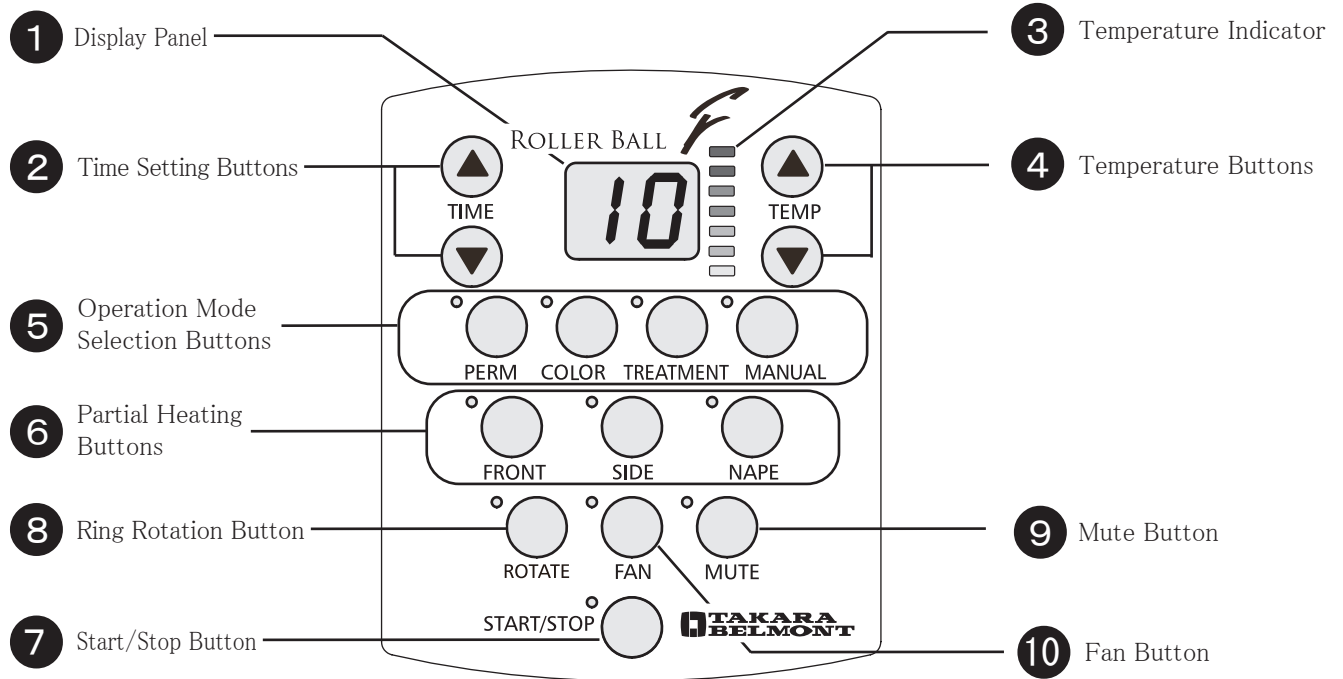

(only for the specification with fan)

Description of Buttons and Indications

<p>1 Display Panel</p> <ul style="list-style-type: none"> - Display the preset operation time. - Display the remaining time. - Display the elapsed time after the completion of operation. <p>(Example) </p> <hr/> <ul style="list-style-type: none"> - Display the error state. <p>(Example) </p> <hr/> <ul style="list-style-type: none"> - Display the cooling operation remaining time. <p>(Example) </p> <p>※Example shows the cooling operation remaining time is 1 minute.</p>	<p>2 Time Setting Buttons</p> <p>- Use these buttons to change the time setting.</p> <p>Each press of the (UP) or the (DOWN) button changes the time in units of a minute. Keep pressing the button changes the time continuously in units of five minutes.</p> <p>* Maximum setting time: 60 minutes.</p>
<p>3 Temperature Indicator</p> <p>- Indicates the current temperature setting.</p> <p>[Display Color]</p> <ul style="list-style-type: none"> Red Red Orange Orange Yellow Yellow Green <p>The lamp illuminates for each 3°C (5.4°F) from the bottom lamp (Green = 34°C, 93.2°F). The lamp at the top (Red = 52°C, 125.6°F) shows the maximum temperature.</p>	<p>4 Temperature Buttons</p> <p>- Use these buttons to change the temperature level.</p> <p>Each press of the (UP) or the (DOWN) button changes the temperature level by one step. The level can be set in seven steps.</p>

Description of Buttons and Indications

5 Operation Mode Selection Buttons and Lamps

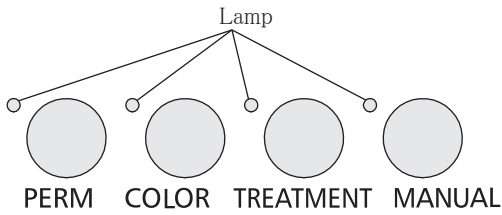

- A mode can be selected by pressing the appropriate button. To customized the changed settings as the standard setting, keep pressing the button chosen for one second or longer. (See the section "Customized Settings" on page 16.)

6 Partial Heating Buttons and Lamps

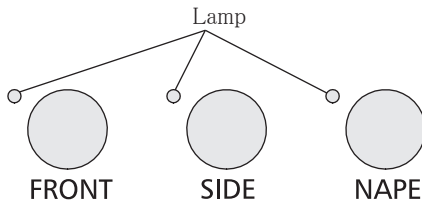

- Partial heating is available by pressing the appropriate button. (See the section "Partial Heating" on page 15.)

7 Start/Stop Button and Lamp

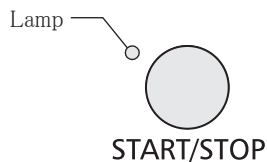

- Press this button to start the operation of each mode. While the equipment is in operation, the button functions as the stop (interruption) button.

8 Ring Rotation Button and Lamp

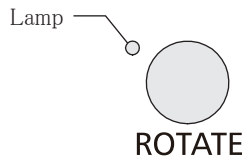

- Use the button to stop or rotate the ring at a desired position.
* Only for the manual mode

9 Mute Button and Lamp

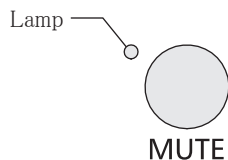

- Use this button to enable the buzzer sound to announce key operations and process completion or to disable (mute) the sound.
* Once the button is pressed, the state of the sound chosen will be maintained until MUTE is pressed again.

Sound enabled: The MUTE lamp is off.

Sound disabled: The MUTE lamp is on.

* Even under the MUTE status, the error sound will not be turned off.

10 Fan Button and Lamp

* Only for the specification with fan

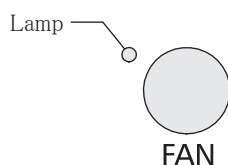

- Use this button to enable (ON) or disable (OFF) the air blowing from the fan.

- The cooling operation will be continued for two minutes after completing the COLOR, PERM, or TREATMENT modes. In addition, air blowing from the fan is possible even during the operation.

Outline of Modes

Description of Modes

Mode	Use
PERM (Dual-step tepid permanent wave agent)	Use the mode for the heating process of the dual-step tepid permanent wave agent. Adjust the mode according to the hair condition, chemicals used, permanent make-up techniques, etc.
COLOR	Use the mode for the acceleration of the color agent. Adjust the mode according to the hair condition, hair agents used, techniques, etc.
TREATMENT	Use the mode for the acceleration of the hair treatment. Adjust the mode according to the hair condition, treatment agents used, etc.
MANUAL	This is the manual mode enabling use that fits the salon's unique techniques. The mode can also be used for partial perming or partial dyeing.

Default Setting of Modes

Mode	Standard Setting						Temperature Control System
	Temp. Level	Time	Heating Position	Rotation	Cooling Time	Fan Operation (during cooling operation) * Only for the specification with fan	
PERM (Dual-step tepid permanent wave agent)	3(40°C, 104°F)	8 min.	Front Side Nape	ON	Specification w/ Fan: 2min. Specification w/o Fan: 1min.	ON	Control with the infrared thermal sensor
COLOR	4(43°C, 109.4°F)	10min.	Front Side Nape	ON	Specification w/ Fan: 2min. Specification w/o Fan: 1min.	ON	
TREATMENT	4(43°C, 109.4°F)	10min.	Front Side Nape	ON	Specification w/ Fan: 2min. Specification w/o Fan: 1min.	ON	
MANUAL	3(40°C, 104°F)	8 min.	Front Side Nape	ON	Specification w/ and w/o Fan: 1 min.	OFF	Control according to the programmed time control

Temperature control by infrared thermal sensor

In PERM (dual-step tepid permanent wave agent), COLOR, and TREATMENT modes, the customer's hair temperature is directly measured with the infrared temperature sensor to control and keep the temperature at the preset level.

Temperature level and temperature settings

The temperature level indication shows the temperatures with an increment of 3°C (5.4°F) in the order of 34°C(93.2°F), 37°C(98.6°F), 40°C(104°F), 43°C(109.4°F), 46°C(114.8°F), 49°C(120.2°F), and 52°C(125.6°F) from the bottom lamp (green) to the top lamp (red).

* Since the manual mode controls the ON and the OFF time of the heater, the temperature may slightly fluctuate according to room temperatures.

Heating position

The ring heater of the rotating ring can be set to turn OFF only when it passes the designated part. The part of FRONT, SIDE, or NAPE whose lamp illuminates on the control panel will be heated.

Example: Press the FRONT button to turn off the lamp, and the ring heater will be OFF only when the ring passes the front part while the ring is rotating.

Error Codes

- If an error code appears on the display panel, take adequate action according to the following table.

Indication	Symptom	Actions to be Taken
The E0 code and the current remaining time indication will blink, alternately.	After operating for three minutes or longer, the surface of the customer's head is hotter than the preset temperature.	Check if the customer's head position is set too far from the heater. If it is, reset it at the correct position. (See page 11.) If the position is correctly set, check that the sensor sheet is clean. If the sheet is not clean due to agents etc., wipe it off completely. Turn off the power, then on again and use it with the head set at the correct position. If the condition does not change after taking this action, contact the nearest dealer or Takara Belmont directly.
	The surface of the customer's head is not warm at all.	Contact the nearest dealer or Takara Belmont directly.
The E1 code and the current remaining time indication will blink, alternately.	The customer's head has moved from the current position, or the temperature of the surface of the head has decreased.	Check the position of the customer's head. Keep the product running. After a while, the error will be cancelled when the customer's head temperature reaches the setting temperature.
The E2 code blinks.	The ring movements are abnormal.	Turn off the power and then on again. If the error condition continues, contact the nearest dealer or Takara Belmont directly.
The E3 code blinks.	The surface of the customer's head is too hot.	Contact the nearest dealer or Takara Belmont directly.

Setting

Be sure to observe the correct use to make the maximum performance of the Roller Ball and to ensure comfortable use by the customer.

Materials of Cap Used

Use a polyethylene cap for perm, color and treatment mode operations.

By using a polyethylene cap, the hair can be heated efficiently to the set temperature, and the infrared thermo sensor will measure and control the temperature of the hair.

Use the manual mode if the cap is not used or if a cap other than the polyethylene cap is used. If the perm, color or treatment mode is selected, the temperature cannot be measured well with the infrared thermo sensor, causing an error code (E0, E1) to appear on the display panel. If an "error code" appears, follow the instructions on [P18].



Use of a cap other than the polyethylene cap in perm, color, and treatment mode may cause abnormal temperature rise.

When using a cap other than the polyethylene cap, use the manual mode.

Safe Rotation Function of Ring

If any part of the customer's body or clothes is caught between the main unit and the ring of the Roller Ball during operation, the rotation clutch mechanism of the ring will work to stop rotation and prevent danger.

Correct Setting Position

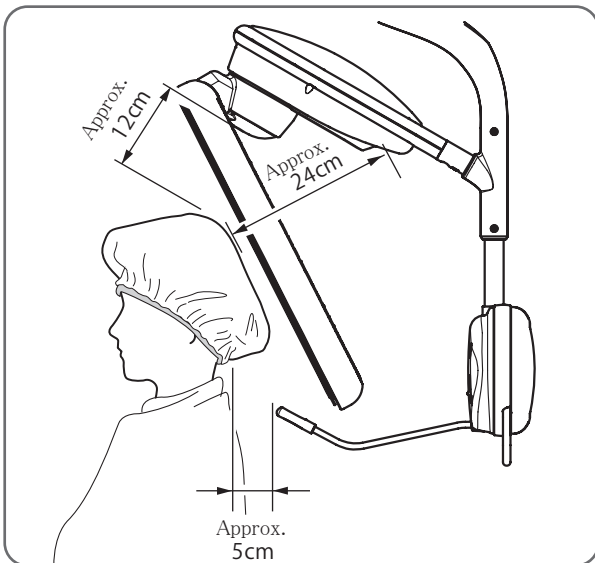

Place the top of the head approximately 12 cm away from the pivot of the ring and approximately 24 cm away from the infrared thermal sensor.
(Approximately 5 cm between the nape guard and the nape).

Setting the Roller Ball in Correct Position

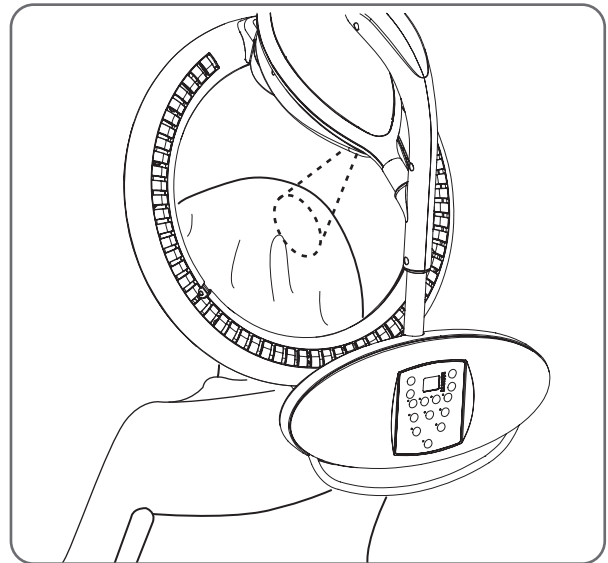

Position the nape guard 5 cm away from the customer's nape and set it at the center of the nape.

Move the chair up or down according to the seating height of the customer or move the Roller Ball main unit up or down to adjust the height.



If the head of the customer is misaligned from the beginning of the operation, an alarm will sound about three minutes after initiation of operation, and the error code **E0** will be displayed.



CAUTION

When setting the product, be careful that the product and the dryer arm do not contact the surrounding equipment or personnel. Furthermore, when moving the product, be sure to hold it by the grip; move the product slowly and carefully. Failure to heed this warning may lead to breakage of the product resulting in burns.



CAUTION

If the customer feels sick while using the Roller Ball, immediately stop using the product.

(The far infrared rays from the Roller Ball will not affect the human body at all, but the customer may feel sick due to the heat if the customer is in poor health condition.)

Setting

Alarm notifying misalignment of head position



When the alarm sounds, ask the customer to return to the correct position.

(For the PERM, COLOR, and TREATMENT modes)

Misaligned position alarm! 



When the product is operated with the customer in the correct position, the infrared thermal sensor directly measures the customer's head temperature to control it to the preset temperature. However, if the head has moved significantly during operation, the infrared thermal sensor will detect it and the alarm will sound. When this happens, the current remaining time and the **E1** code will blink alternately on the display panel.

If the misaligned head position warning alarm is left unattended, the unit may fail to maintain the correct temperature, and this may cause an unsatisfactory results. When the warning alarm sounds, be sure to ask the customer to move back into the correct position. When the customer's head is in the correct position, the error state is cancelled.

Customer's head temperature may take a while to reach the preset temperature. To quickly cancel the **E1** error, follow the instructions given in below <How to deal with an error> and restart the operation.

<How to deal with an error>

If **E0** or **E1** error occurred, follow the below instructions.

Press Start/Stop button to stop the operation. Reset the customer's head position to the correct position.

Press Start/Stop button again to restart operation. If the error still appears, turn off the power, unplug the unit, and contact the nearest dealer or our company directly.



CAUTION

After using the product, move it to a position where the salon works are not interrupted. Leaving the product in the operating position may cause the product to contact other devices or personnel resulting in breakage of the product.

Ring Rotation

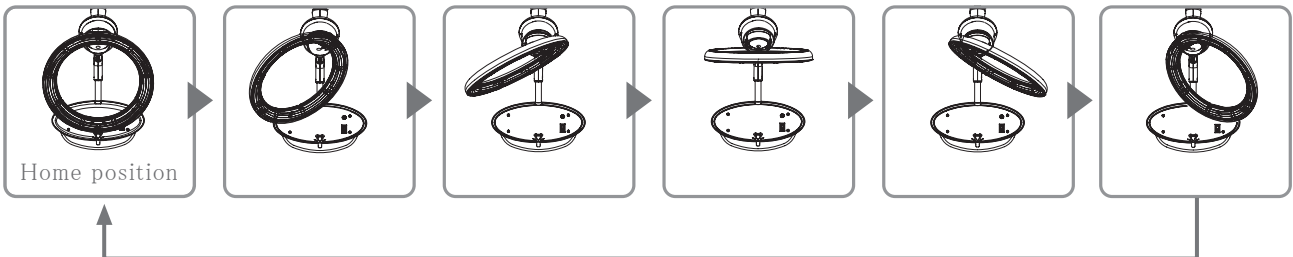

<Rotation of the Ring>

In the COLOR, PERM, and TREATMENT modes, the ring rotates about four times per minute over the customer's head while different parts of the ring lighting as it rotates. The rotation of the ring with different parts of lighting not only warms the entire head evenly, but makes the customer feel that the heating is mild.

Information

The ring may sometimes wobble during rotation, but this is not a failure.

Operating Procedures

Time Setting Buttons

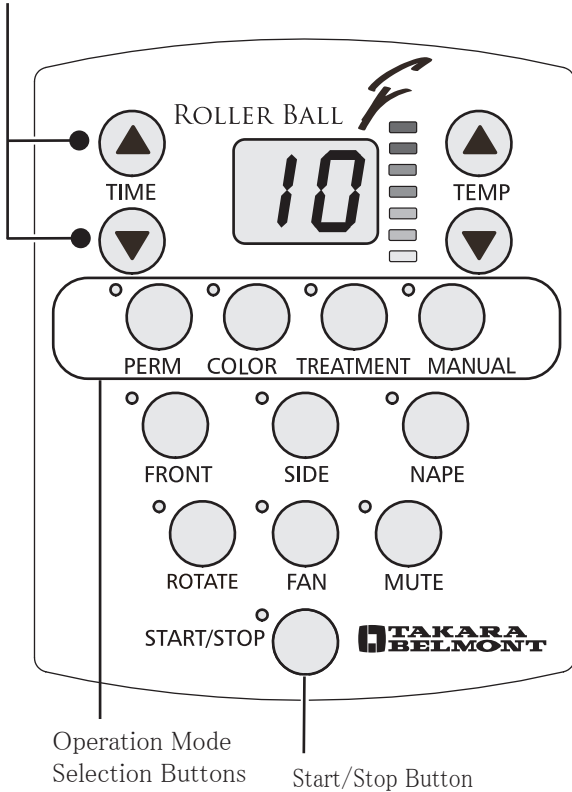

Operation Mode Selection Buttons

Start/Stop Button

1 Set the Roller Ball in the correct position.

If the unit is not set in the correct position, it will not work properly. (See page 11.)

2 Turn on the power switch.

When the power switch is turned on, all lamps will illuminate for one second, and then only the operation mode lamps will blink, showing the state of waiting for mode selection.

3 Select a mode.

Press the mode selection button. When the button is pressed, the lamp of selected button illuminates and the standard setting (temperature level, time, etc.) is displayed. Check the setting.



Changing the settings should be done according to the hair condition of the customer, chemicals used, process of the service, etc.

4 Press the Start/Stop button.

When the Start/Stop button is pressed, the ring begins rotating and operates according to the settings (temperature level, time, heating position).

5 During Operation

During operation, the Start/Stop button illuminates. And the selected mode and the decimal point of time indication blink at intervals of one second, and the remaining time is displayed.



The heater is hot. Never touch the heater even when it is not glowing.

Information

The head part of the product uses gears. The sliding friction noise of the gears fluctuates in terms of the tone quality and sound volume of the products.

Returning the ring to the home position for another new use during the operation.

It is possible to interrupt the operation and select a new mode within the five minutes in order to use the product for a different customer.

To use the ring from the home position, follow the procedure below:

1. When the product is in the interrupted state, keep pressing the time setup ∇ button until the display time reaches 0.
2. Press the Start/Stop button twice.

Operating Procedures

[Changing the settings during operation]

Settings excluding mode selection can be changed during the operation.

※For the setting of ring rotation and stop, it can be changed only for manual mode.

[Interrupting the operation]

Press the Start/Stop button during operation to stop ring rotation and heater control, and the Start/Stop lamp blinks.

During interrupted operation, the setting can be changed. When the mode is changed, the operation mode shifts to the changed mode, and the operation is in the standby state.

Press the Start/Stop button within five minutes after interrupting the operation to resume operation. If the Start/Stop button is not pressed within five minutes, the mode will reset to the mode before starting operation.

[Warning of Head Position Misalignment]

(For COLOR, PERM, and TREATMENT modes)

If the customer's head moves from the correct position and the infrared heater is not heating the head correctly, the infrared thermal sensor will detect it and a warning alarm will sound every 30 seconds. If this happens, ask the customer to return to the original position. If this condition is not corrected, it may cause an unsatisfactory results.

6 Cooling

When the preset time has elapsed and the time indication is zero (0), the cooling operation will be started.

Specification w/o Fan

Cooling process continues for one minute.

- * During the cooling operation, the ring will rotate when the heater is OFF.
- * For the ring-fixed operation in manual mode, cooling operation is not executed.

Specification w/ Fan

Cooling process continues for two minutes. During the cooling operation, cold air will be blown from the fan.

- * In manual mode, the fan will not operate during the cooling process, and as is the case with the specification w/o fan, the cooling time is one minute.

7 Time-up

When the preset time has elapsed, the time indication shows 0, the electronic alarm indicating a time-up will be heard. The ring will stop at the home position.

[Counting the elapsed time]

After the timeout, the elapsed time will be indicated by a blinking lamp.

[Memory Function]

The elapsed time after timeout is displayed up to 60 minutes. When the Start/Stop button is pressed during this time, the setup that was used last will be displayed. (This function is useful when checking the preset time and the practice result in comparison.) The memorized data becomes invalid when the mode is changed.

8 Be sure to turn off the power switch when finished.

Rotation and Stopping of Ring during Operation

Only for the Manual Mode

Operation	State of Ring Rotation Button during Operation	
	For regular use (Ring rotation button: ON)	For use where the ring rotation is stopped under the manual mode (Ring Rotation button: OFF)
During operation	The ring rotates. The heater is ON.	The ring stops at the position of the manual mode stop. The heater is ON.
When the operation is interrupted	The ring stops at the position when the button is pressed. The heater is OFF.	The ring remains in the stop state. The heater is OFF.
When the operation is resumed in five minutes after interruption	The ring starts to rotate. The heater is ON.	The ring remains in the stop state. The heater is ON.
During cooling time	The ring rotates. The heater is OFF.	*The cooling time is not provided for the fixed operation under the manual mode.
After cooling time	The ring rotates to the home position and stops there. The heater remains to be OFF.	

Partial Heating

When either of the heating positions (FRONT, SIDE or NAPE) is turned off, the temperature control is subject to the ON/OFF control of heater according to the programmed time.

The temperature control with the infrared thermal sensor will not be executed.

1

Set the Roller Ball in the correct position.

If the unit is not set in the correct position, it will not work properly. (See page 11.)

2

Select a mode.

Press the operation mode selection button after turning on the power switch. At this time, check the temperature level and the time setting for the selected operation.

3

Select a heating position.

Press a partial heating button (FRONT, SIDE or NAPE).

*The heater of the rotating ring can be set to OFF only when it passes the designated part.

4

Press the Start/Stop button.

Press the Start/Stop button to rotate the ring under the selected conditions.

Customized Settings

1. Customizing Settings in Modes

It is possible to adjust the initial settings in each mode as required. (customized settings)
(The initial settings are displayed when the mode selection button is pressed.)

The customized settings are stored in memory even after turning off the power.

*During the operation or interrupted operation, the settings will not remain in memory.

1. Select the mode selection button in which you would like to customize the settings.
2. Change the setting for temperature, time, or heating position.
3. Keep pressing the mode button for one second or longer. An electronic beep sound will be heard, and the new settings are stored.
4. Release the finger from the mode button. The new settings are now stored.
5. Turn off the power, and then on again. Check that the settings are correct.

2. Reverting to the Default Settings

This procedure restores the default settings (factory settings).
(Factory setup: see page 9)

1. Turn on the power while pressing the Start/Stop button.
2. An alarm sound will be heard after one second, and the mode settings are restored to the default settings.
3. Release the finger from the Start/Stop button, and the procedure is completed. Check the settings.

Lamp Indication During Operation and Inputs from Button

Mode and Operation		START/STOP	PERM COLOR TREATMENT MANUAL	TEMP	TIME	FRONT SIDE NAPE	ROTATE	FAN ※Option
Power ON	Lamp Indication	1 sec <input type="checkbox"/> ON → OFF	1 sec <input type="checkbox"/> ON → Blink	1 sec <input type="checkbox"/> ON → OFF	1 sec <input type="checkbox"/> BB → OFF	1 sec <input type="checkbox"/> ON → OFF	1 sec <input type="checkbox"/> ON → OFF	1 sec <input type="checkbox"/> ON → OFF
	Button Input	×	○	×	×	×	×	×
Before Operation	Lamp Indication	Blink	Selected mode <input type="checkbox"/> ON	<input type="checkbox"/> ON	<input type="checkbox"/> ON	<input type="checkbox"/> ON	<input type="checkbox"/> ON	<input type="checkbox"/> ON
	Button Input	○	○	○	○	○	Manual only ○	○
During Operation	Lamp Indication	<input type="checkbox"/> ON	Selected mode <input type="checkbox"/> ON	<input type="checkbox"/> ON	<input type="checkbox"/> ON Count down	<input type="checkbox"/> ON	<input type="checkbox"/> ON	<input type="checkbox"/> ON
	Button Input	○	×	○	○	○	Manual only ○	○
During Interruption	Lamp Indication	Blink	Selected mode <input type="checkbox"/> ON	<input type="checkbox"/> ON	Blink	<input type="checkbox"/> ON	<input type="checkbox"/> ON	<input type="checkbox"/> ON
	Button Input	○	○	○	○	○	Manual only ○	○
Cooling	Lamp Indication	Blink	Selected mode <input type="checkbox"/> ON	OFF	Blink Count down	OFF	<input type="checkbox"/> ON	<input type="checkbox"/> ON
	Button Input	○	×	×	○	×	×	○
Completion	Lamp Indication	Blink	OFF	OFF	Blink Count up	OFF	<input type="checkbox"/> ON	OFF
	Button Input	○	×	×	×	×	×	×

Note: Items marked with the "○" accepts input from buttons, while items marked with the "×" do not accept input from buttons.

Note: The elapsed time after finishing the operation (cooling time) will be counted up to 60 minutes. Press the START/STOP button to reset the conditions to those at the time of START.

Troubleshooting

When a problem cannot be rectified even if an inspection is made according to the table shown below, immediately stop using the product, turn off the power switch, disconnect the power plug, and immediately contact the nearest dealer or Takara Belmont directly.

Phenomenon	Check Point	Countermeasures
No power. (No indication on the control panel)	Is the power plug correctly inserted into the wall outlet?	Insert the power plug firmly into the wall outlet.
	Is the power switch turned on?	Turn ON the power switch.
	Is the fuse on the distribution panel or the breaker switch in the salon in the ON position?	Set the fuse on the distribution panel or the turn ON the breaker switch.
	Is the fuse (located at the lower side of the main unit) blown?	Turn off the power switch, and contact the nearest dealer or Takara Belmont directly.
	Is the problem rectified when the power plug is disconnected and then inserted again?	Immediately stop using the product, turn off the power switch, disconnect the power plug, and then immediately contact the nearest dealer or Takara Belmont directly.
There is an odd smell from the heater.	Is a chemical adhered to the heater or the reflection plate?	If dust, dirt, or chemicals adhere to the heater or the reflector, the fouling will cause a transient fire and will emit smoke. When the amount of fouling is minute, the smoke will stop when the fire burns out, causing no damage to the product. If the fouling is substantial or the smoke does not stop, turn off the power switch and contact the nearest dealer or Takara Belmont directly.
There are clicking sounds from the ring.	—	The heater expands when it gets hot, and shrinks when it gets cold. The noise is caused as certain parts come into contact with each other. This is not a failure.
There is friction noise from the product while the ring is rotating. The sound volume or the tone quality sometimes differs in a same product.	—	The head part of the product uses gears. The sliding friction noise of the gears fluctuates in terms of the tone quality and sound volume by products. The fluctuation in tone quality and the friction noise are not failures.
The ring wobbles during rotation.	—	The head part of the product uses a motor. The ring may wobble due to vibrations of the motor, which is not a failure. Furthermore, the level of wobbling differs depending on the product.
The temperature level must have been lowered than before. (The temperature is hotter than before.)	Is the sensor sheet contaminated?	Remove the contamination on the surface of the sensor sheet according to the Section "Care and Maintenance" on page 19. If the problem is not be rectified, turn off the power switch and contact the nearest dealer or Takara Belmont directly.
The heater will not glow red. *Depending on the thermal control of the heater, the heater may seem as it is off.	Has the temperature around the heater increased?	When the air around the heater becomes warm, the heater has not failed. If the temperature has not risen, stop using the product, turn off the power switch, disconnect the power plug, and immediately contact the nearest dealer or Takara Belmont directly.

Troubleshooting

When a problem cannot be rectified even if an inspection is made according to the table shown below, immediately stop using the product, turn off the power switch, disconnect the power plug, and immediately contact the nearest dealer or Takara Belmont directly.

Phenomenon	Check Point	Countermeasures
The E0 error illuminates.	Check if the customer's head position is not set too far away from the correct position. (See page 11.)	If the error code appears continuously even where the customer's head set in the correct position, turn off the power and contact the nearest dealer or Takara Belmont directly.
The E1 error illuminates.	Check if the customer's head position is not set too far away from the correct position. (See page 12.)	If the error code appears continuously even where the customer's head set in the correct position, turn off the power and contact the nearest dealer or Takara Belmont directly.
The E2 error illuminates.	Check if anything such as the other appliance or the wall is in contact with the ring.	Move the product to the position where the ring does not contact with wall or other equipment, and turn off, then turn on the power. If the above-stated action does not rectify the symptom, turn off the power and contact the nearest dealer or Takara Belmont directly.
The E3 error illuminates.	Check if the Roller Ball is set in the correct position properly. When the customer's head may be set too far from the correct position, the infrared thermal sensor detects heat from a surrounding heater and so on, leading to the E3 error.	Turn on the power after setting the product in the correct position. If this does not rectify the symptom, turn off the power and contact the nearest dealer or Takara Belmont directly.

USER MAINTENANCE INSTRUCTION

Splashing of water on the control panel or metal parts may result in product failure or rusting. Immediately dry the product with a soft cloth.



The product should not be exposed to moisture and water.

The plastic, plated, or painted parts should be wiped with a dry and soft cloth.



When fixed contamination or oil adheres to the product, wipe it off with a soft damp cloth with a water-diluted neutral detergent.

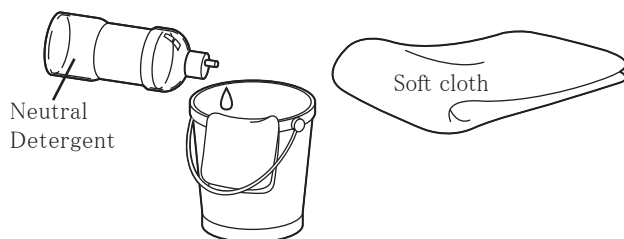

Never use volatile chemicals such as thinner, alcohol, gasoline, and kerosene; detergents containing organic materials; acidic-, alkaline- or chlorine-based detergents; and wax containing abrasive compound, sponge, scrubber, etc.

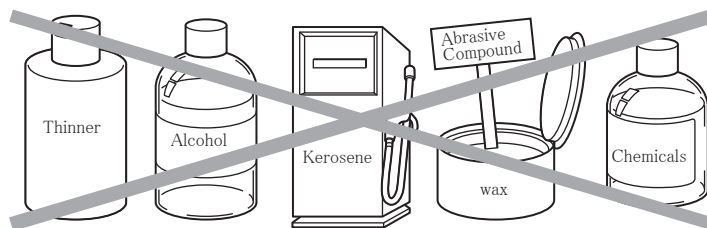

Daily Inspection Procedure



WARNING

Be sure to observe daily inspection according to the following guidelines. Continued use without observing the daily inspection may result in failure or accidents.

To use the product safely, be sure to observe the following inspections.

■ Daily Inspection Items (Pre-Operation Check)

Inspection Item	Inspection Procedures	If the inspection results show defects:
<input type="checkbox"/> Check if there is no deformation, breakage, or deterioration of the power plug or the power cord of the dryer arm.	Check before operating the product: <ul style="list-style-type: none"> <input type="checkbox"/> There is no deformation breakage or deterioration on the power plug or the power cord. Check while the product is in operation. (this is limited to the case that there is no deformation breakage or deterioration on the power plug or the power cord) <input type="checkbox"/> The power plug or the power cord may be heated when it is deteriorated. Touch to check if the power plug or the power cord becomes hot while the product is in use. 	There is a possibility of electrical shock or burn injuries due to fire or electrical leakage. Since some parts must be replaced, immediately stop using the product, turn off the power switch, disconnect the power plug, and immediately contact the nearest dealer or Takara Belmont directly.
<input type="checkbox"/> Check if there is no breakage or deterioration on exterior parts.	Visually check the entire product and check for any breakage or deterioration of the exterior parts, etc.	Restrictions in bringing out the expected functions of the product may result in accidents (injuries including burns). Immediately stop using the product, turn off the power switch, disconnect the power plug, and immediately contact the nearest dealer or Takara Belmont directly.
<input type="checkbox"/> Check that the power switch operates properly and the lamps on the control panel illuminate.	Check if there is no jamming when turning ON/OFF the power switch. In addition, check that all of the lamps illuminate right after turning on the power switch.	If the product is used with the power switch functioning improperly, failures such as unexpected shutdown of power during operation may occur. Furthermore, in the state that the lamps on the control panel do not illuminate, the product may not be used correctly because the setting state cannot be confirmed. If this is the case, immediately stop using the product, turn off the power switch, disconnect the power plug, and immediately contact the nearest dealer or Takara Belmont directly.
<input type="checkbox"/> Make sure that the wall mount bracket does not wobble.	Move the product attached to the dryer arm and check the movement.	If you note problems such as the wall mount bracket is swinging from at its base on the wall, disconnect the power plug and immediately contact the nearest dealer or Takara Belmont directly.
<input type="checkbox"/> Make sure that the devices attached to the dryer arm are not loose.	Move the product attached to the dryer arm and check the movement.	If you note problems such as the device is swinging from at the joint part with the dryer arm, disconnect the power plug and immediately contact the nearest dealer or Takara Belmont directly.
<input type="checkbox"/> Make sure that the dryer arm operates safely without any problem.	Move the product attached to the dryer arm and check the movement.	If you note any problem, disconnect the power plug and immediately contact the nearest dealer or Takara Belmont directly.

Any other servicing should be performed by an authorized service representative.

Dimensions and Specifications

Dimensions

-mm-

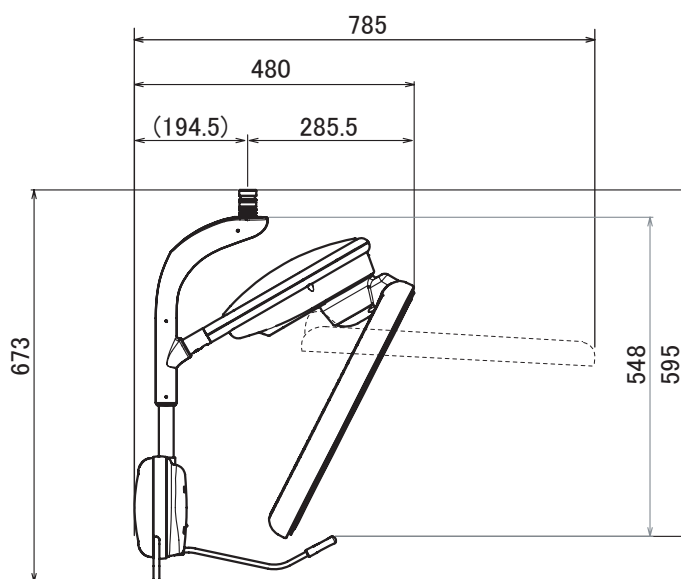
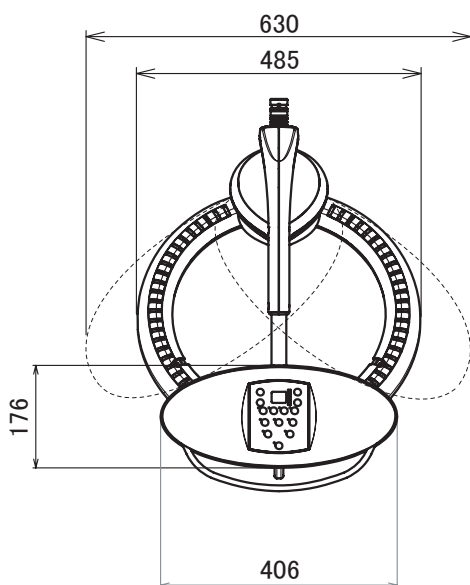
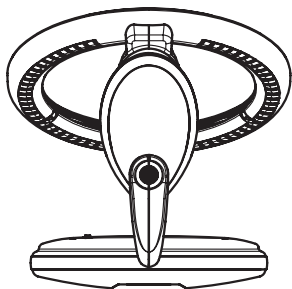

Specifications

Model No.	AK-S23A	AK-S23AF
Weight	8.0kg	
Safety device	Rotation clutch mechanism Power supply fuse	
Rated voltage	AC120V	
Frequency	50/60Hz	
Rated power	980W	985W

*Specifications are subject to change without notice.

Dimensions and Specifications

Dimensions
-mm-

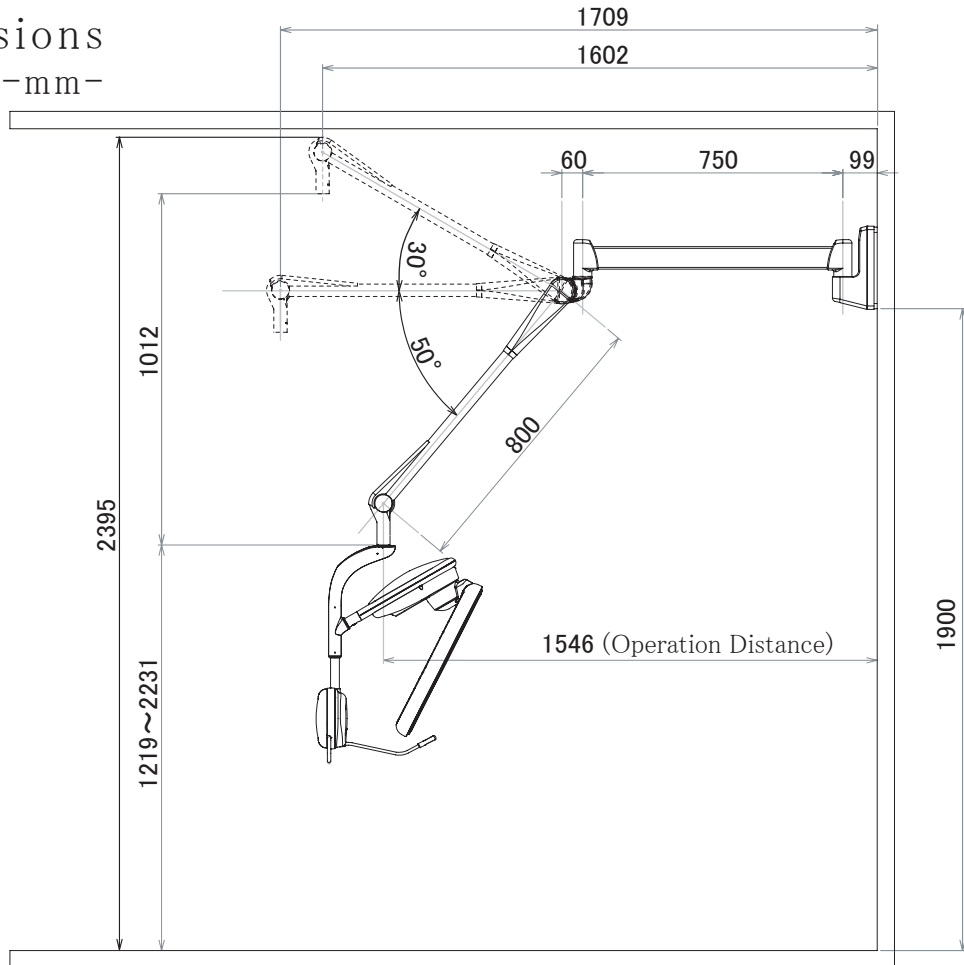

* The above shows reference values when the lower end of the wall mount plate is installed at a height of 1900 mm from the floor surface.

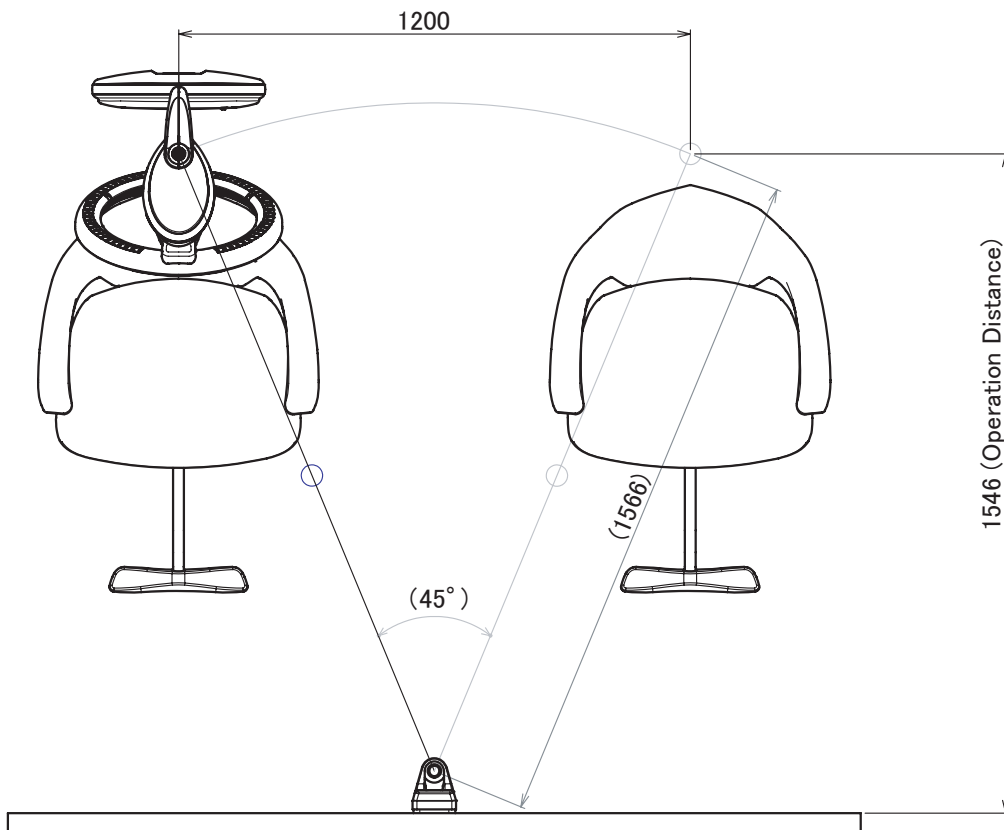

Note