

Takara Belmont Ultrasonic Steamer



MICRO MIST

Product No. **AK-200**

Operating Manual

Translation of the original instructions

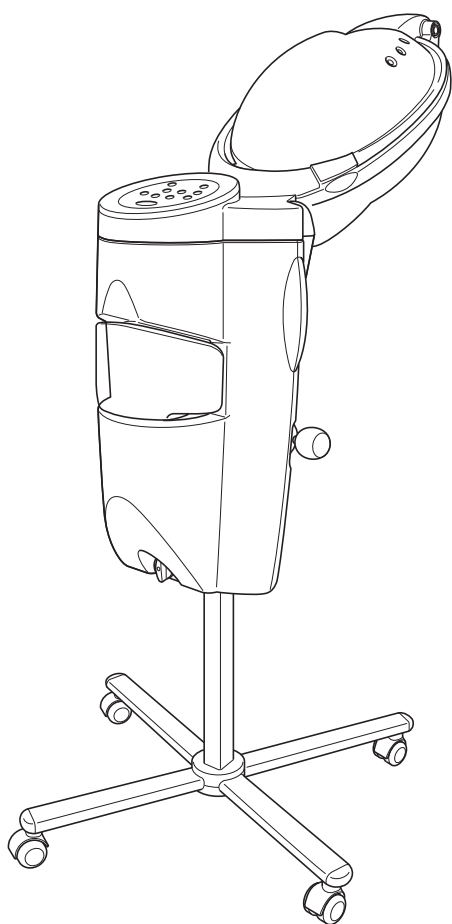

Thank you for purchasing our Belmont Micro Mist ultrasonic steamer.

Please read this manual before using the ultrasonic steamer.

Keep this manual in a place where it can be easily referred to when necessary.

Contents

Safety Cautions and Warnings 2

Location of Warning Labels·Specifications 4

Assembly Instructions 5-6

Component Parts 7

Control Panel 8

Preparation for use 10

Usage

Positioning the Unit 12

Fitting the Face Guard 12

Setting the Operating Mode 13

Operations during Mist Generation 14

After the Mist Operation is complete 15

Maintenance 17

Display Codes 18

Troubleshooting 19

Thank you for purchasing our product. Please read through this manual and this note carefully before installing or using.

These instructions provide important information for correct usage of the product to avoid personal injuries or property damages against you or your clients.

This product is intended for the exclusive use in hair salon or esthetic salon for their treatment and service, and must be operated or handled by the qualified/professional hairdressers or by their staff under the supervision of hairdressers.

2023.12 10th Version











Request No. 1A0FTNA0

Safety Cautions and Warnings









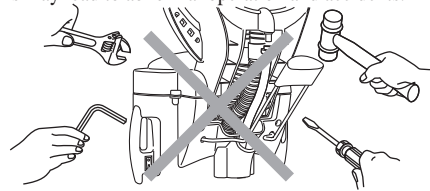

Signs and Symbols

Before Using This Product

Carefully read through and familiarize yourself with the "Safety Cautions and Warnings".
 The precautions indicated here are designed to prevent harm and injury to you and your customers and to facilitate the safe use of the product.
 All are important in maintaining safety and should be strictly followed.

 WARNING	Indicates a precautionary items which, if not strictly followed, will result in death or inserious injury.	
 CAUTION	Indicates a precautionary items which, if not strictly followed, will result in injury or physical damage.	
 General Symbol for Caution, Warning and Danger	 General usage precaution symbol	 Prohibited location
 Remove electrical power plug from outlet.	 Do not get wet or use in wet locations.	 Do not dismantle, attempt to repair or modify.
 Possibility of high temperatures being generated.	 Connect ground wire.	 MANUFACTURER

Please strictly observe these precautions.

 Warning	
 <p>This unit must be earthed. This is to prevent electric shock in the case of malfunctions or short circuits.</p>	 <p>Do not disassemble or attempt to repair. Disassembly, repair or modifications should only be done by a qualified repair technician. Attempts at disassembly, repair or modifications may lead to abnormal operation and accidents.</p> 
 <p>Do not climb on the stand or main unit. Do not lean or climb on the stand or main unit. Doing so may cause it to tip over and cause injury or damage.</p>	 <p>Follow the rules for handling the power plug.</p> <ul style="list-style-type: none"> Do not connect another electrical appliance to the same outlet. Push the power plug all the way in to secure it. Do not attempt to move the main unit by pulling on the power cord. This may lead to the unit tipping over and may cause damage to the cord. Do not twist the power cord or place heavy objects on it. Twisting the cord or putting heavy objects on it may result in electric shock or start a fire. Do not handle the power cord with wet hands. This may lead to electric shock. 
 <p>Do not touch operating parts. Keep your hands and fingers clear of the operating sections of the hood and support. Touching them may cause injury.</p>	
 <p>Do not put your hands or foreign objects in the Water Container Holder. The internal section gets hot during operation and may cause burns if touched. If a foreign body falls into the internal section, turn off the power, and contact our service center or sales office.</p>	
 <p>Keep hands and feet away from the discharge outlet during discharge. There are cases when boiling water will spray out, which could result in burns.</p>	 <p>Unplug the steamer when it will not be used for a long time. Remove the power plug at the end of the workday or when performing maintenance. Fires started by electrical shorts may be caused by the degradation of insulation. If the supply cord is damaged, it must be replaced by the manufacturer or its service agent or similarly qualified person in order to avoid a hazard.</p>
 <p>Keep the main unit dry. Do not wipe the main unit section with wet cloths, etc. or allow water to come into contact with it. Doing so may lead to electric shock or malfunctions.</p>	



Caution



Use the handle to move the unit.
Do not try to move the unit using the stand or the hood.
This may cause it to tip over.

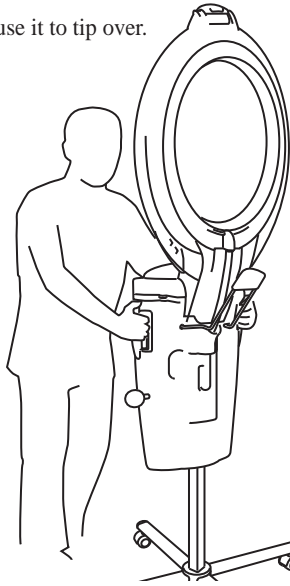

Do not move the main unit using the Nape Bar.
This may lead to the unit tipping over and may cause damage to the Nape Bar.

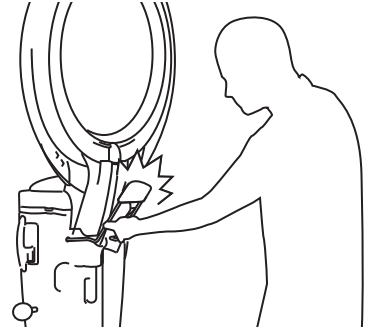

Do not apply force to the Hood.
This may lead to the unit tipping over and may cause damage to the Hood.

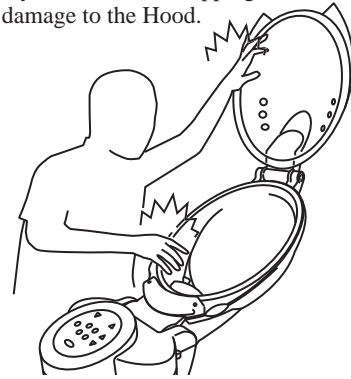

Put the hood up when moving the main unit.
Failure to do so may lead to it hitting customers or equipment.



Do not shake the unit while it is in operation.
This may cause water leakage or overflow.

In case of overflow, follow the instruction on page 18 and discard the water in the Main Unit.

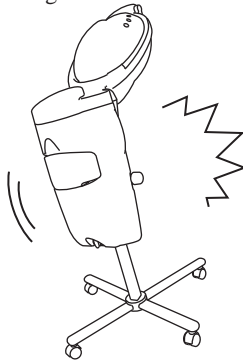

Do not put anything other than purified water made for the steamer/purified water into the Water Container.
Do not put things such as permanent liquid, cosmetic liquids, perfumes or mineral water into the supply tank. Doing so may lead to malfunctions or cause allergic skin reactions.

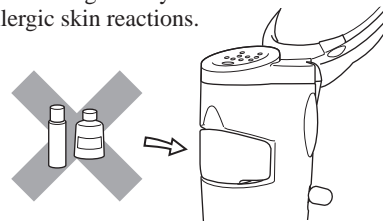

Do not use tap water.



Do not put boiling water in the Water Container.
This will cause the internal section to heat up and may lead to malfunctions.



Do not touch the Water Container Cap immediately after operation ceases.
The Water Container Cap will still be hot right after operation and touching it may lead to being burned.



Promptly wipe off any chemical spills.
When treatment, permanent, or coloring chemicals come into contact with the unit, use a damp cloth to wipe them off as soon as possible. Failure to do so may cause surface staining or discoloration.



Do not use with chemicals for cold temperature permanent waves.
Do not use with cold permanent wave chemicals. Their use may lead to allergic skin reactions.

Locations of Warning Labels

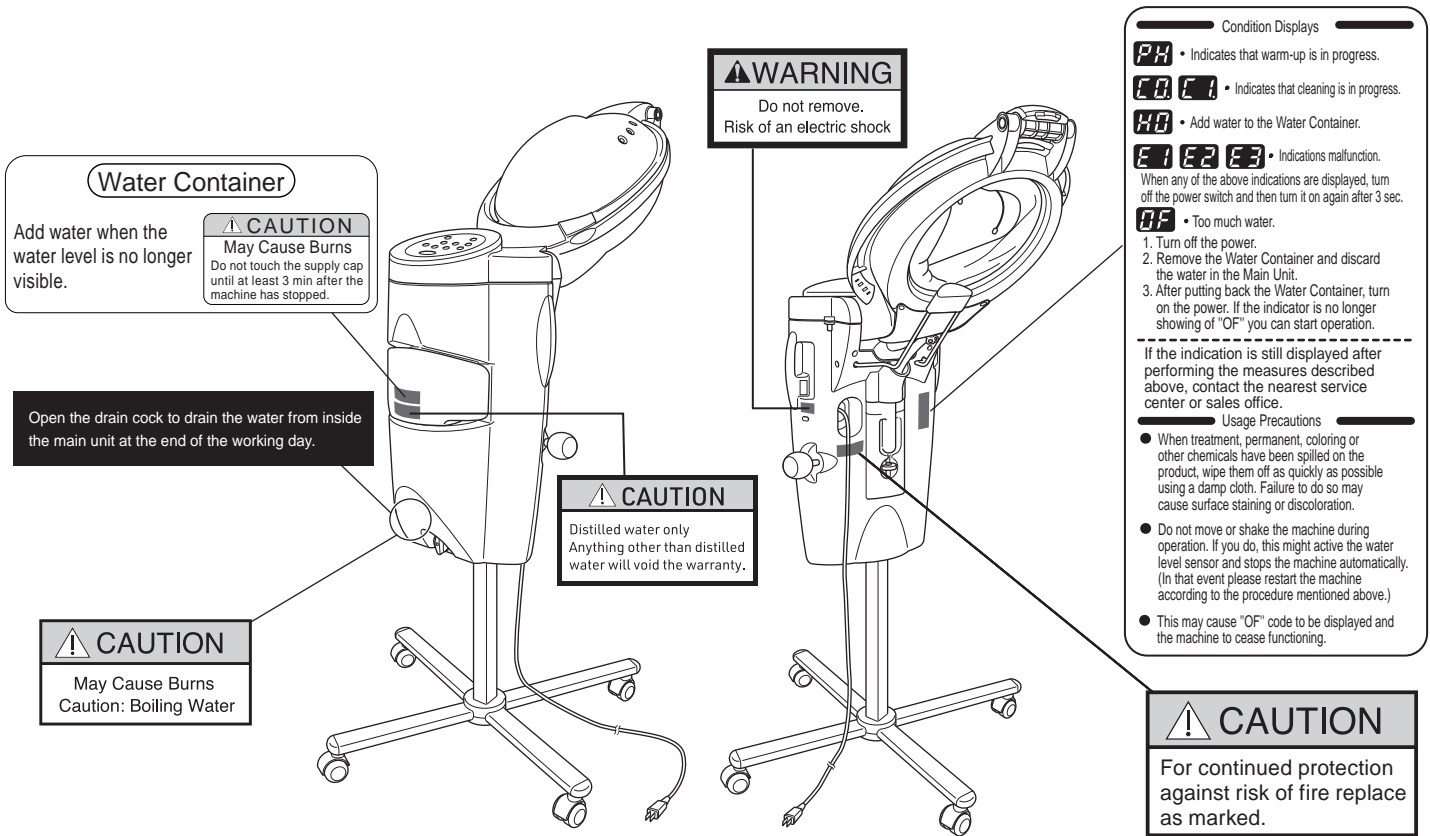

Specifications

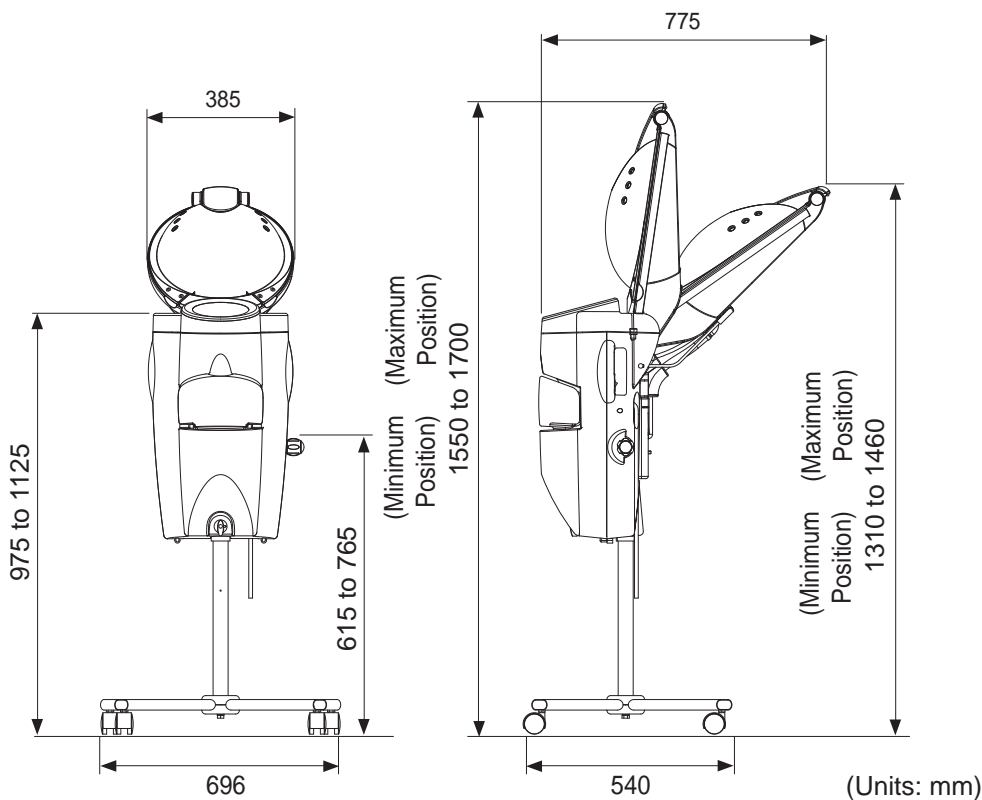

Product No.	AK-200
Rated Voltage	110V/120V 220V/230V/ 240V
Rated Frequency	50/60 Hz
Rated Power Consumption	490 W
Water Container Capacity	2000 ml
Drain Tank Capacity	350 ml
Weight	25.0 kg

Assembly Instructions

1. Attaching the Base Stand

- ① Remove the main unit body (AK-200) and place it on the packing case, positioning it as shown in the illustration on the right.

*Use the two handles (depressions) on the side to pick up the main unit.

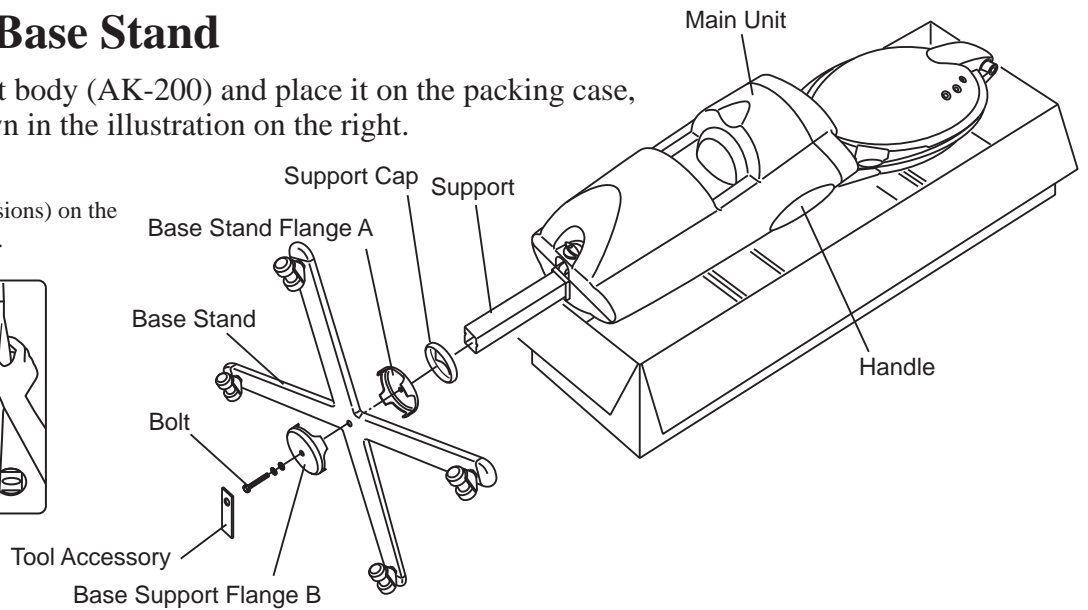
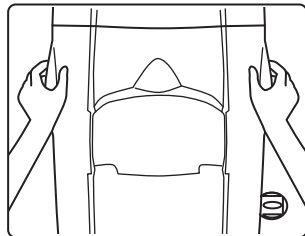

- ② Use the following procedure to fix the Base Stand (AY-200) in position with the bolt and tool.

- 1) Attach the accompanying Support Cap in the direction shown in the illustration.

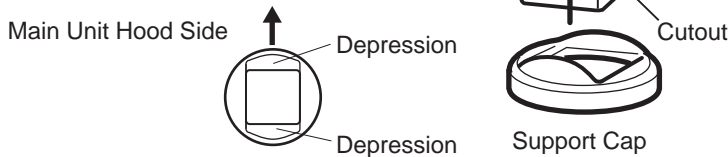

- 3) Line up the 'Cutout' and the 'Convex Part' and tighten the bolt.

Caution Exercise caution so that the bottom of the Support does not scratch Base Stand Flange A.

- 2) Use the positioning decal to confirm the attachment position of Base Stand Flange A and the Base Stand.

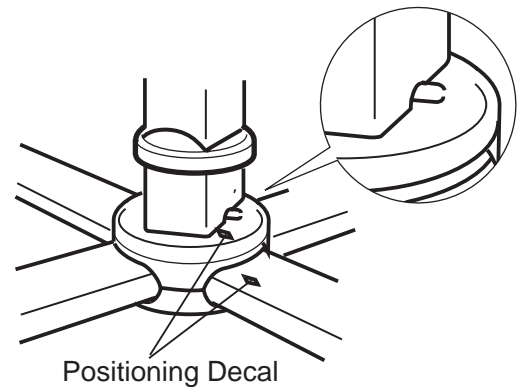
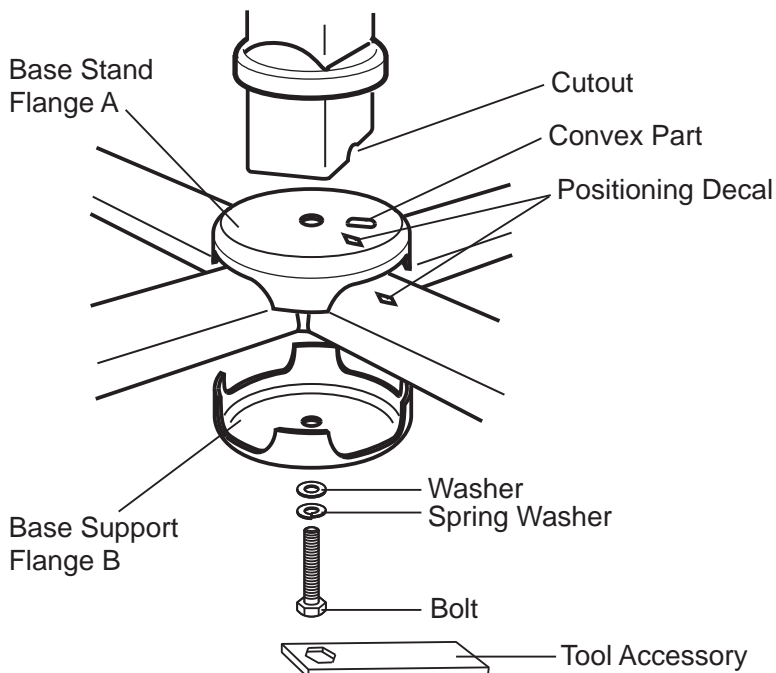

- 4) Press the Support Cap downwards.

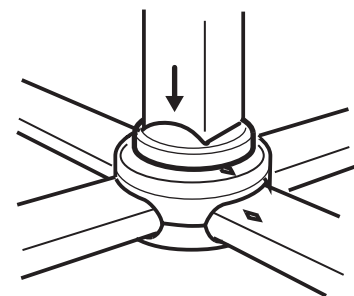

Assembly Instructions

2. Remove the Compression Cap Bolt.

Caution Stand the unit up before removing the cap bolt. Working on it while leaving it lying flat runs the risk of having the Support fall out. It may also cause damage to the support.

- 1) Stand the unit up after attaching the Base Stand.
- 2) Before proceeding further, fully tighten the Height Adjustment Knob.

Caution Loosening the Height Adjustment Knob while the unit is in a compressed state will cause it to rise suddenly. Exercise care in handling the unit.

- 3) Remove the cap bolt using the included wrench and remove the washer and sleeve as shown in the illustration.

Caution Be sure to remove the washer and sleeve. Leaving them attached to the Support may cause damage to the product.

- 4) Loosen the Height Adjustment Knob. Be sure that the main unit can be moved up and down.

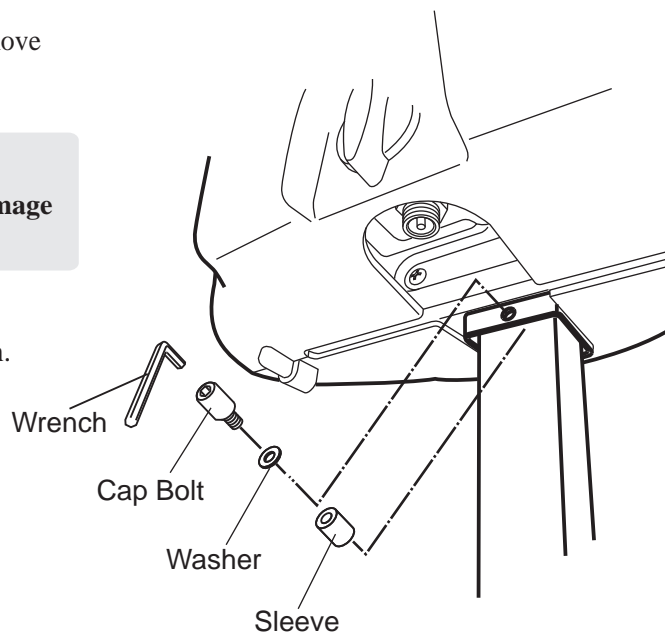
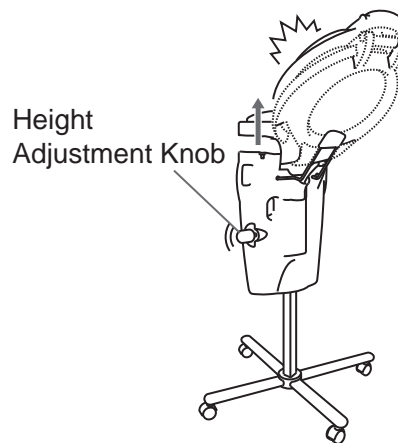

3. Attaching the Nape Bar

- 1) Firmly push the Nape Bar into the attachment holes as far as it will go.

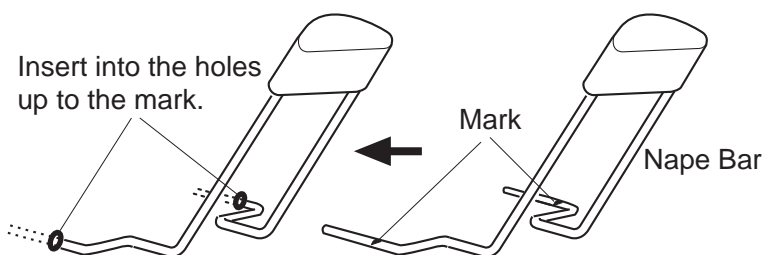

Be sure that the left and right sides of the Nape Bar have been fully inserted up to the marks.

Caution Push in the Nape Bar until both ends have gone as far as they can go. Position adjustment cannot be done when the unit is in use.

- 2) Use the included wrench to tighten the screws (left and right) that have been left loosely tightened.
- 3) After tightening the screws put the caps (left and right) over the screw holes.

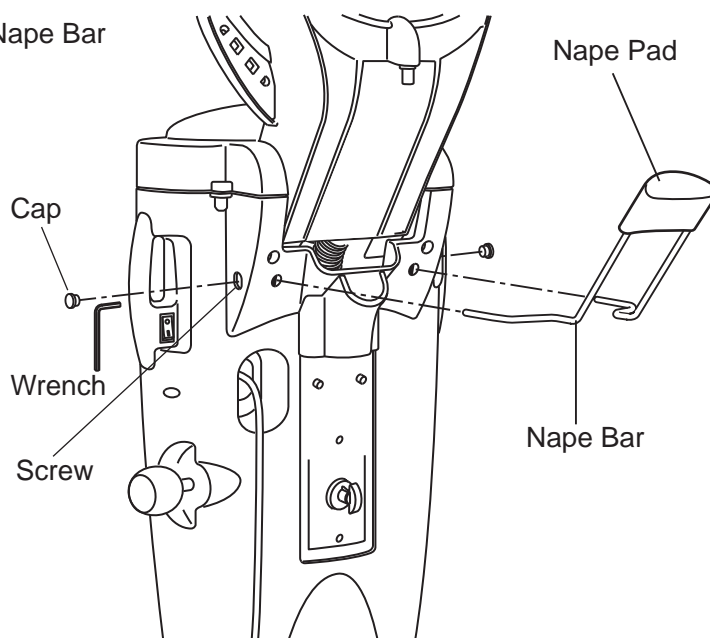

Component Parts

As for the included parts, please refer to the appendix (Accessories).

Main Unit - Rear

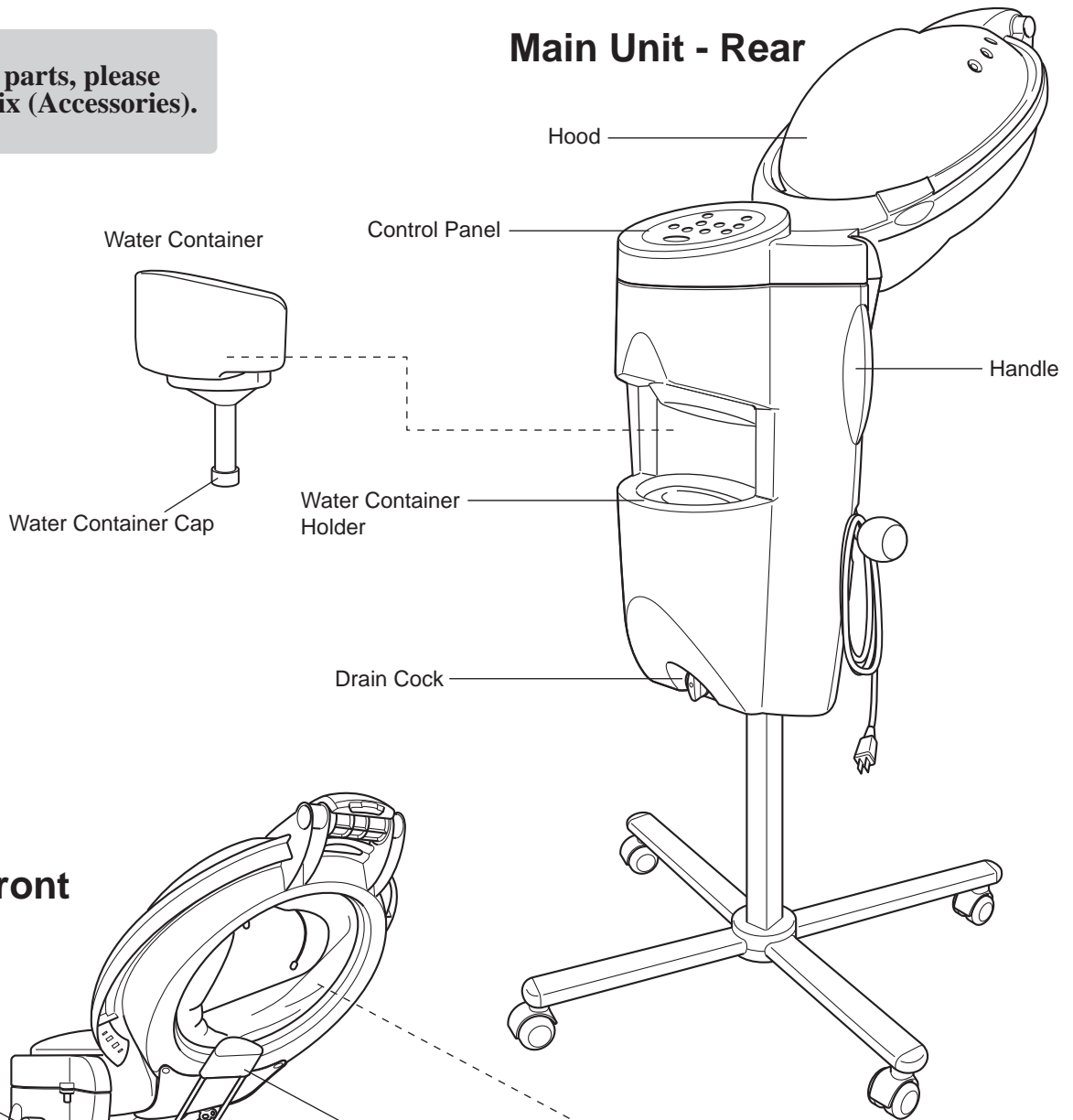

Main Unit - Front

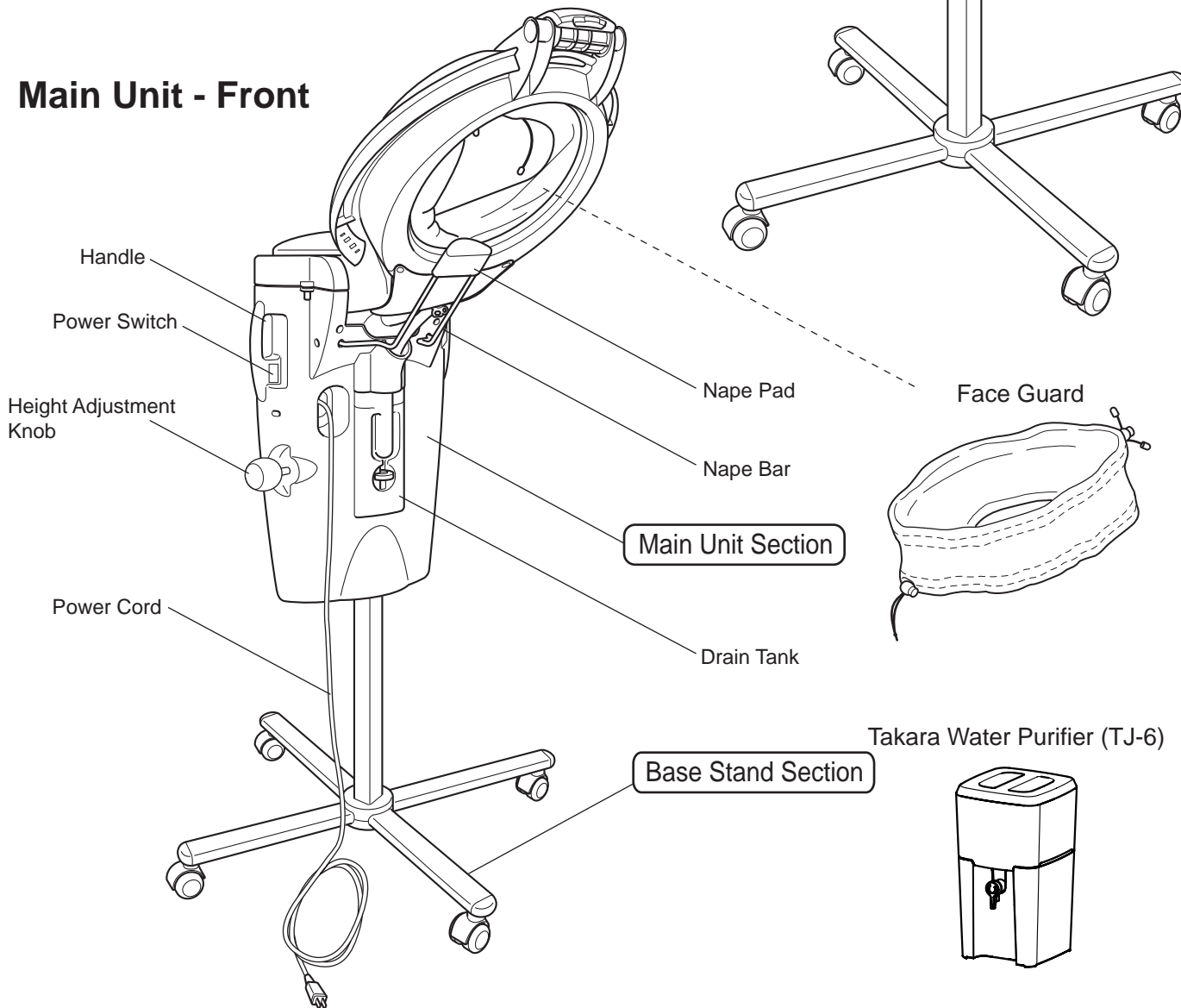

Control Panel

Time Setting Key

- Use this to change the time that has been set.
- Pressing on ▲ (UP) and ▼ (DOWN) together will change the time in 1-minute increments each time they are pressed.
- Keeping the keys depressed will change the time in succession (0 to 60 minutes).

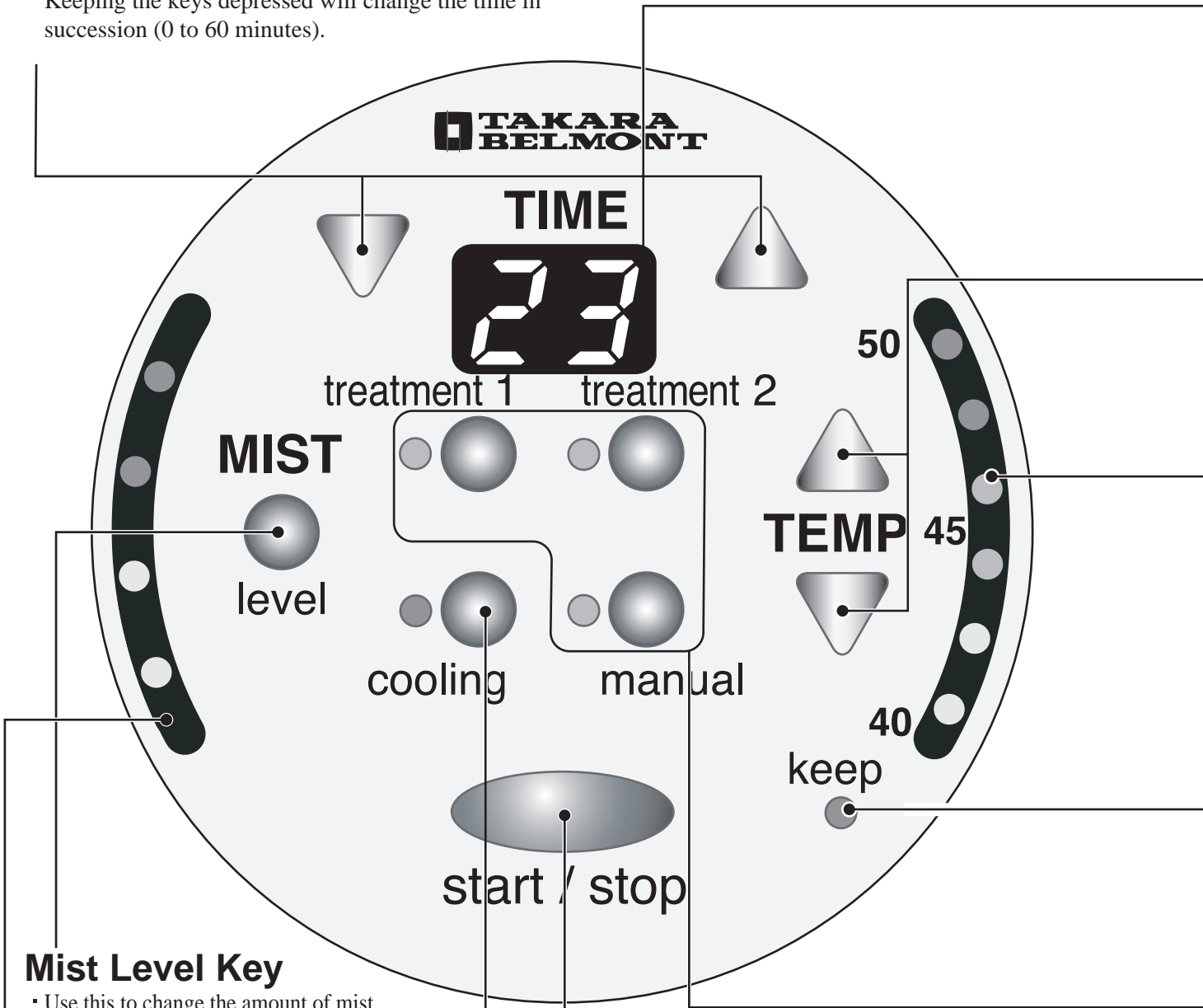

Mist Level Key

- Use this to change the amount of mist.
- Pressing on it will increase the level by one each for time it is pressed.
- (The level will revert to Level 1 after Level 4 has been reached)

Mist Level Lamp

Level*	1	2	3	4
Mist Amount	Light → Heavy			
Lamp Color	Yellow		Red	

start/stop Key

- Use this to start the operation of each mode.
- Use this to stop operation.
- Pressing the start key after a mode has been exited will result in starting under the settings that were in effect the time before. (Removing the power plug will invalidate the operating mode settings)

cooling Key

- Select whether or not to use cooling after the Mist operation stops.
- (Cooling is ON when the lamp is lit)

*In operation at a low Mist Level setting (1, 2) no mist may be visible to the naked eye for a short period after operation begins (about a minute); however, a misty breeze is actually being emitted. This is not a malfunction.

Display Panel



Shows the operation time set or the remaining operation time.



No water in the Water Container.



Warm-up in progress.
(Preheating)



Too much water.
(Overflow)



Cooling in progress.



Indicate malfunctioning.

Temperature Level Key

- Use this to change the temperature of the mist.
Pressing ▲ (UP) or ▼ (DOWN) will change the level each time they are pressed.
(The heater is OFF at Level 0)

Temperature Level Lamp

- Shows the temperature at 7 levels.

Level	0	1	2	3	4	5	6
Normal Hood Internal Temperature(°C)		40.0	42.0	44.0	46.0	48.0	50.0
Lamp Color	Unlit	Yellow		Orange		Red	

*There may be slight variations in the Standard Hood Internal Temperature depending on usage.
The Standard Hood Internal Temperature is the temperature at approximately 5 minutes after the start of operation.
In operation over long periods of time, the actual temperature may be slightly higher than that displayed.

keep Lamp

- The heated state is maintained as long as this lamp is on.
(Heat maintenance is terminated after 20 minutes has elapsed)

treatment1/treatment2/manual Key

- Each key has the operating mode set by Mist Level, Temperature Level and Time registered.
Press on the key to turn on the lamp and select the operating mode.
(One of these has to be selected at starting time)
After selecting each mode, adjust the Mist, Temperature and Time to desired levels.

	Mist Level	Temperature Level	Time	Cooling Time
treatment1	3	3	8 minutes	2 minutes
treatment2	1	2	10 minutes	2 minutes
manual	4	5	5 minutes	2 minutes

Preparation for Use

Put water in the Water Container

1. Remove the Water Container Cap and add the water.

Be sure to use distilled water, or use water through Takara Water Purifier (TJ-6). Check the condition of TJ-6 with the provided purifier checker and replace the cartridge regularly. For instructions for use, see the enclosed Operating Instructions.



- Do not put anything other than distilled water in the container. (e.g. cosmetics, aroma oil, perfumes, or mineral water)
- Do not pour boiling water in the container.

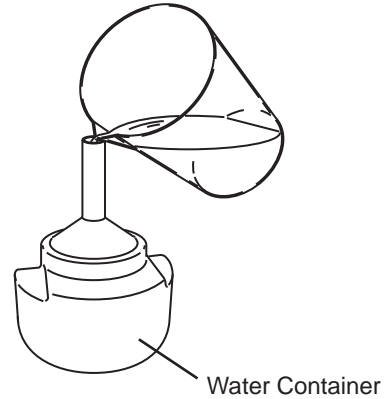

2. Replace and tighten the Water Container Cap.



- Tighten the Water Container Cap so that water will not leak out.

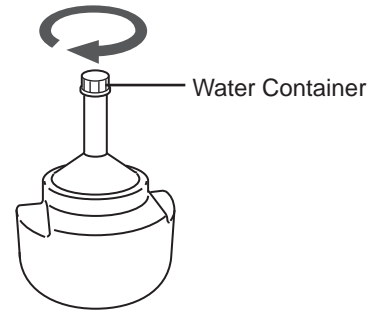

3. Check to make sure the Drain Cock is closed.

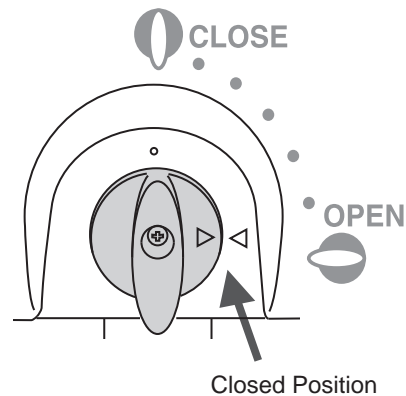

4. Insert the Water Container into the Water Container Holder.

*Hold the Water Container with both hands and gently insert it.

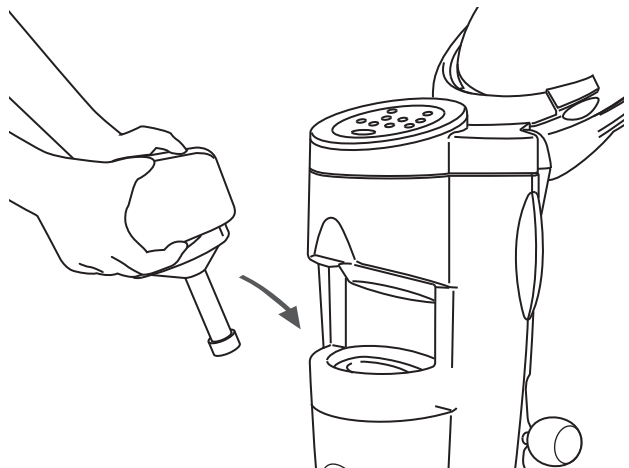

Fastening the Face Guard to the Hood

1. Loosen the strap at the bottom (the woven cord side) of the Face Guard.

*The side with the crossed strap is the top part and the side with the strap to be fastened by the ends is the bottom part.

2. Attaching the Face Guard to the inside frame of the Hood.

This installation can be eased by using the 2 tabs in the upper section of the frame and covering from top to bottom.

3. Tighten the strap in the bottom section of the Face Guard.

Adjust the upper section strap (the resin cord side) position so that it comes to the front edge of the Hood. Open up the strap in the upper section sufficiently to accommodate the customer's head.

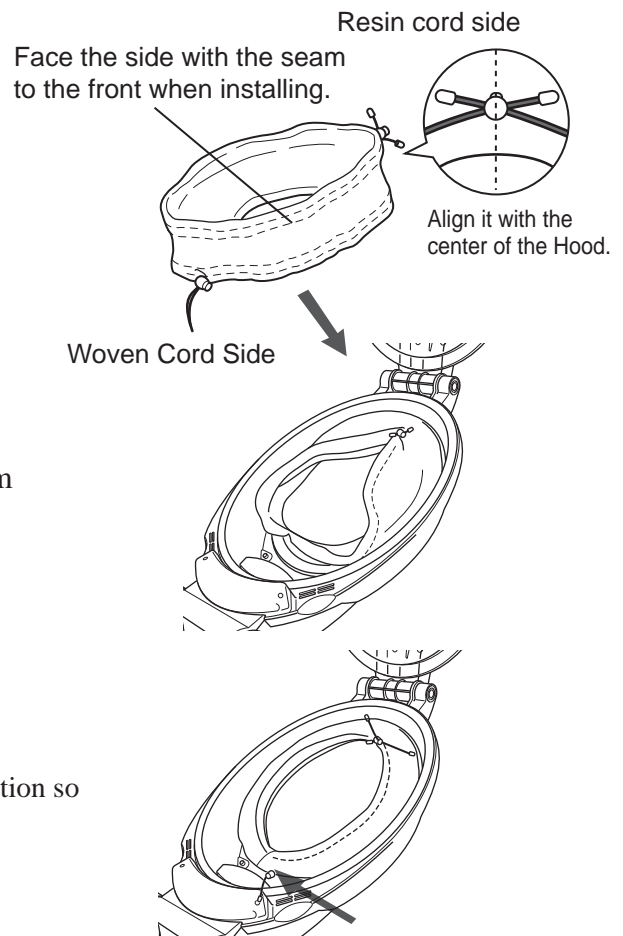

Turn on the power

1. Insert the power plug in the electrical outlet.

Caution

- Do not connect another electrical appliance to the same outlet. Push the power plug all the way in to secure it. Remove the plug at the end of the workday or when the steamer will not be used for a length of time.

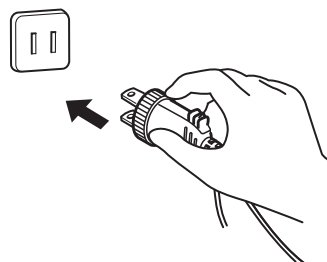

2. Turn on the Power Switch.

Turning on the power switch a few minutes before use will shorten the time up to the generation of mist.

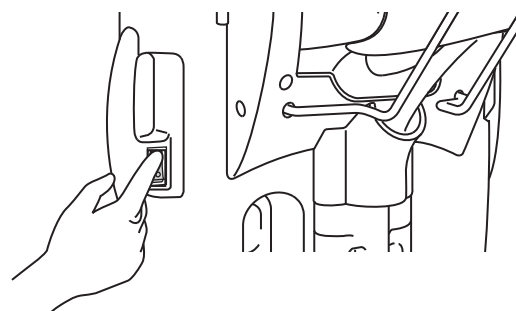

Setting the Main Unit

Finish preparing the customer (up to the attachment of the towel-turban) before setting the Main Unit.

1. Setting the Main Unit behind the customer.

- Move the Main Unit to behind the customer.
- Loosen the Height Adjustment Knob on the Main Unit to move the Nape Bar up or down so that it touches the nape of the customer's neck (the center part of the back of the turban).



Turban Rear Center Section

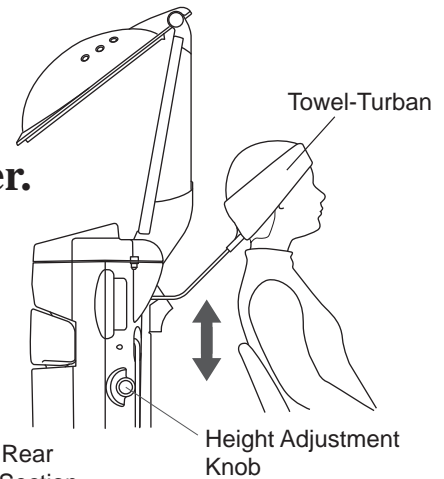

2. Open the upper cover, and lower the Hood while checking the customer's position.

For smoother operation

Allow time for heating after adding purified water. Turn on the Power Switch 2 minutes or more before starting in order to allow the steamer to warm up.

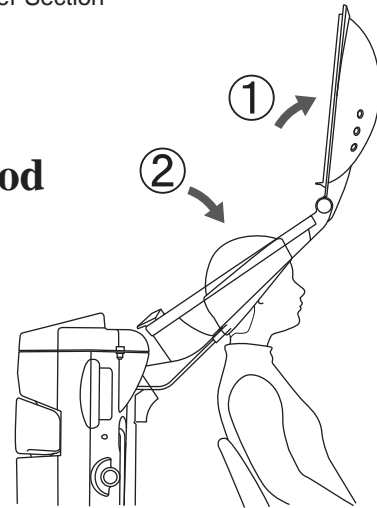

Fitting the Face Guard

1. Adjust the Face Guard from the inside of the Hood so that it comes to a position above the turban.

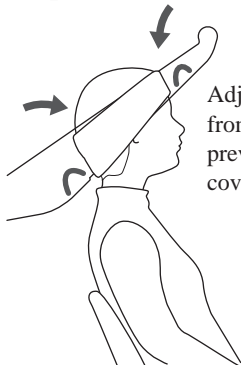

Adjust it so that insertion is done from the nape of the neck side to prevent the Face Guard from covering the customer's face.

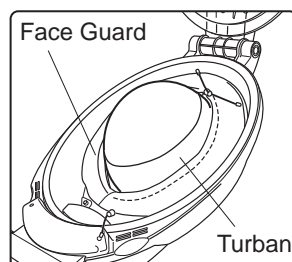

2. Tighten the crossed strap (resin cord side) from the inside of the Hood and fit the Face Guard.

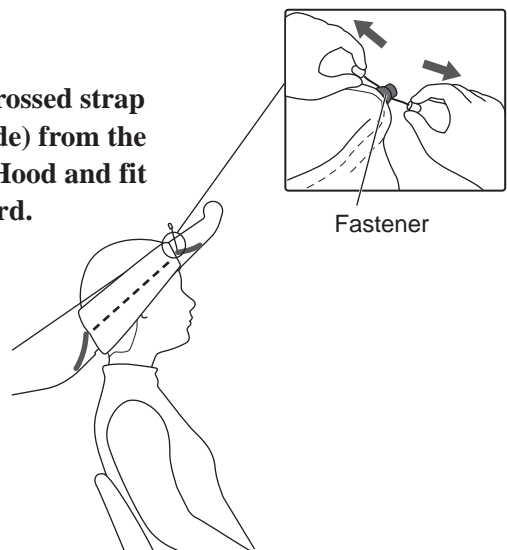

*Tighten the Face Guard so that it will rest on the top of the Towel-Turban (above the dotted line).

Close the Upper Cover

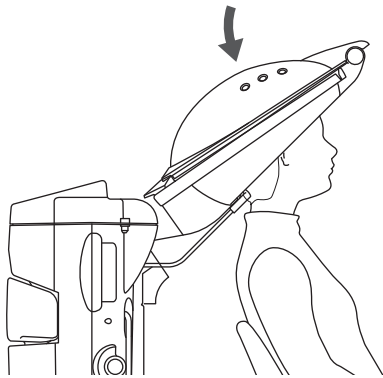

Check to make sure that there is no space between the Face Guard and the customer's head and then slowly close the top cover.

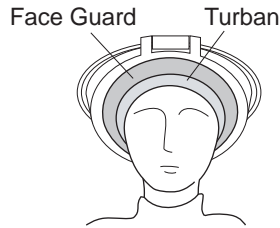

Set this so that the space from the Face Guard to the Turban appears uniform.

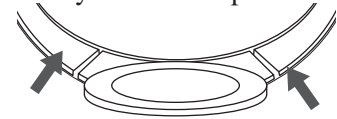

*Press firmly until both right and left sides close with a click.



- When you close the upper cover, don't close it with strong might. This may cause the dumper to break.
- The capacity of the dumper deteriorates as you use.

Setting the Operating Mode

Check to see that the Power has been turned on.

1. Select the mode to be used from among treatment1/treatment2/manual.

*Operation cannot be started until a mode has been selected.

Once a mode is selected, the mode setting prior to it is stored in memory until the power is turned off.

	Mist Level	Temperature Level	Time	Cooling Time
treatment 1	3	3	8 minutes	2 minutes
treatment 2	1	2	10 minutes	2 minutes
manual	4	5	5 minutes	2 minutes

2. Change the setting conditions using the Mist, Temperature and Time keys.

*In the case where the basic settings are to be used when starting changes are not necessary.

3. Press the start/stop key.

Operation will begin with the conditions that were set.

- **PH** and **10** (the time set) will go on in turn on the Display Panel and the Temperature Level lamp will blink on and off.
- Automatic operation will begin once the water inside the machine has been heated.
- It may take a while for the mist to be generated when the water inside the machine is cold.



Caution

- Do not change the Temperature setting during warm-up (while the **PH** lamp is blinking on and off).
- Changing the Temperature level during warm-up will cause the Temperature level to go to 0 (Temperature Level lamp in an unlit state) and may result in mist that is lower in temperature than the set level being generated. In addition, the Temperature Detection Section may judge that a malfunction has occurred and cause the **E2** display to appear. The same thing may occur when the Temperature Level is raised during operation when it is at Temperature Level 0. Thus, the operations described above should not be attempted. In these cases, the **E2** display does not indicate a malfunction. Turn off the power switch and then turn it on again to resume operations.

Operations during Mist Generation

During operation the selected mode lamp and the time display colon will flash alternately and the remaining operating time will be displayed on the Display Panel.

Changing conditions during operation

Press the key that corresponds to the setting to be changed.

- ① Operating Time
- ② Mist Level
- ③ Temperature Level
- ④ Cooling Enabled/Disabled

*Setting the Operating Time to 0 will end the mist operation.

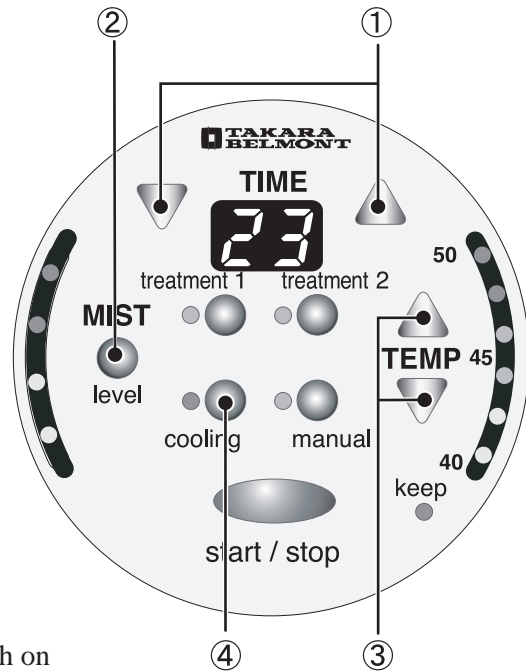

Interrupting operations

Press the start/stop key.
The Mist Level and Temperature Level lamps will flash on and off while the machine is paused.

Changing conditions while paused

Press the key that corresponds to the setting to be changed.

- ① Operating Time
- ② Mist Level
- ③ Temperature Level
- ④ Cooling Enabled/Disabled
- ⑤ Change Operating Mode

*When the Operating Mode is changed, operations will start in the new mode from the beginning.

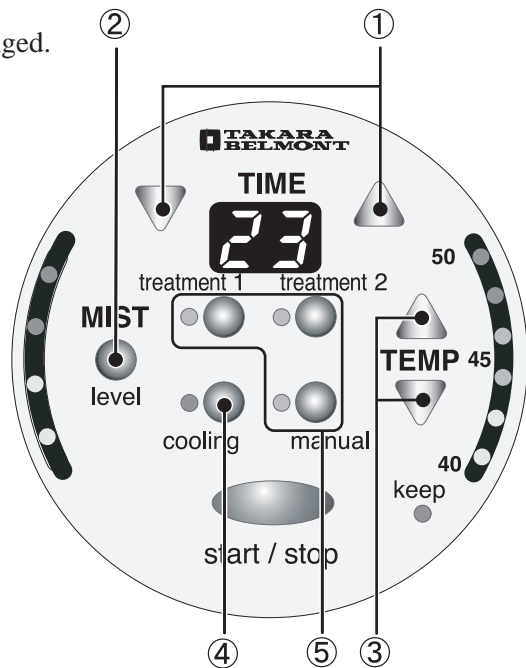

Resuming operations

Press the start/stop key.

After the Mist Operation is complete

An electronic alarm (2 beeps) will sound to announce that time is up when the time set for the Mist Operation has elapsed (the time display will be at 0) and the cleaning time period (2 minutes) will begin. When the cleaning time period ends, the electronic alarm will sound (3 beeps) and the heat maintenance period (20 minutes) will begin. (The keep lamp will light up)

*In the case where Cleaning has been set to OFF when making the settings, the heat maintenance period begins immediately after the completion of the Mist Operation.

Unattended Time Count

*After the cleaning operation has ended, the Unattended Time (including the cleaning time) will be displayed by flashing it on and off.

Removing the Face Guard

1. Open the Upper Cover.
2. Press on the fastener button and loosen the crossed strap.
3. Loosen the Face Guard and move it away from the customer's head.
4. Close the Upper Cover, then lift up the Hood and move the Main Unit.

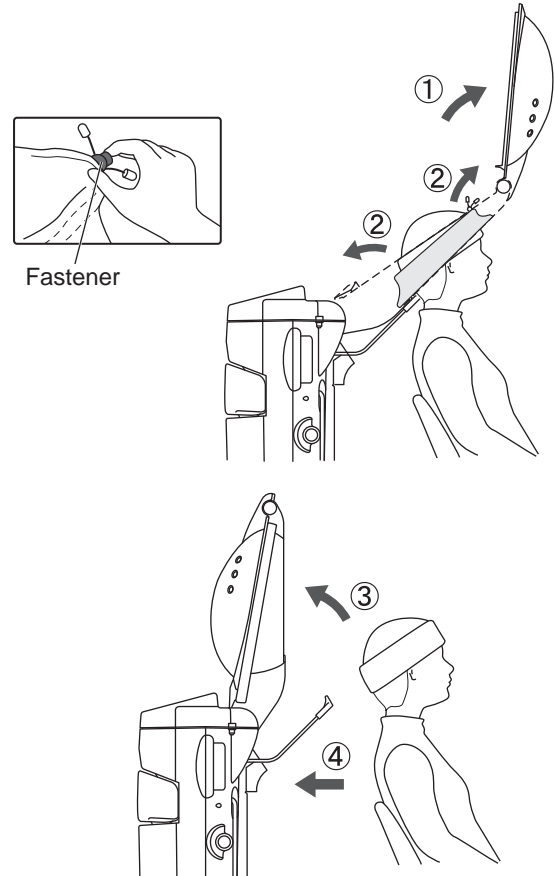

Caution

- When you close the upper cover, don't close it with strong might. This may cause the dumper to break.
- Check to make sure the Face Guard has been removed before raising the Hood.

When using the machine consecutively with multiple customers, check the water level in the Water Container and the Drain Tank before using it.

Turning off the power

Turn off the Power Switch after completing operations.

*Turning off the power will invalidate the operating mode settings.

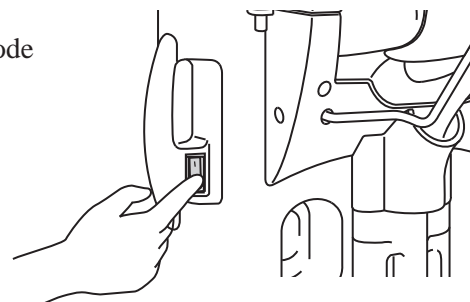

Discarding the Drain Tank water

Remove the Drain Tank at the front of the Main Unit and discard the water accumulated in it.

1. Raise the Hood.
2. Move the Cock that keeps the Drain Tank in place to an upright position.
3. Grasp the bottom of the Drain Tank and pull it in a downward direction towards you.
4. Discard the water and then reverse the procedure to replace the tank.

*When installing the Drain Tank, check to see if the Drain Hose is in the tank.

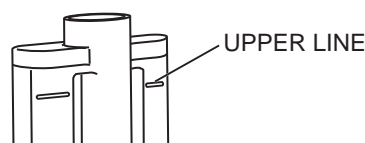
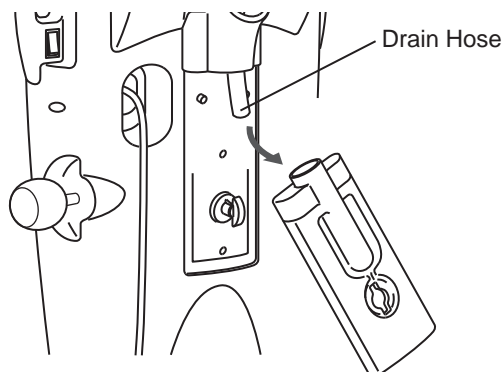
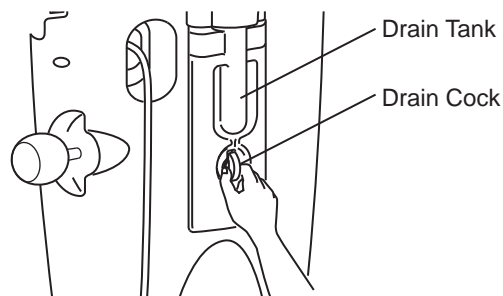

- Discard the water before the water fills up to the UPPER LINE of the Drain Tank.

Discarding the water in the internal section after operations are completed

Discarding the water after finishing operations prevents the formation of scale, which can be a cause of malfunctions.

1. Remove the Water Container and discard the water. Wash out the Water Container.
*If detergent is used for cleaning, be sure to rinse it out well.
2. Turning the Drain Cock 90 degrees to the right will discharge the water (boiling water) inside the Main Unit.

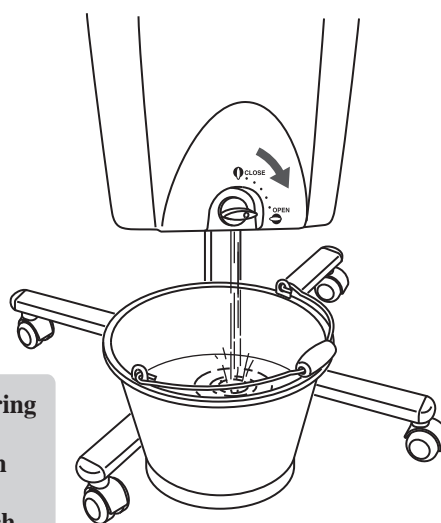

- Keep hands and feet away from the discharge outlet during discharge.
There are cases when boiling water will spray out, which could result in burns.
Remove the water inside the Main Unit at the end of each day.
Water left inside may become a source of foul odors.
Water inside the Main Unit may freeze in cold climates.
Remove the water to prevent damage from freezing.

Maintenance

Caution

Unplug the machine when carrying out maintenance.

The inside section of the Hood gets dirty easily, so it should be wiped clean periodically.

Hair stuck inside or chemicals may cause malfunctions and become a source of foul odors.

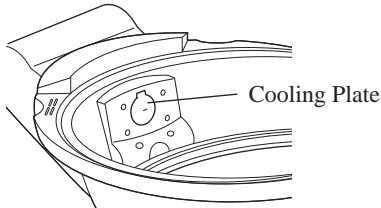
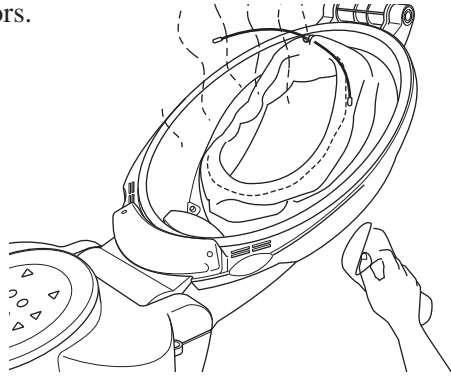

Open the cooling plate and clean up the chemicals around the cooling plate. The chemicals left in the cooling plate may cause the cooling to malfunction.

When treatment, permanent, or coloring chemicals come into contact with the unit, use a damp cloth to wipe them off as soon as possible.

Failure to do so may cause surface staining or discoloration.

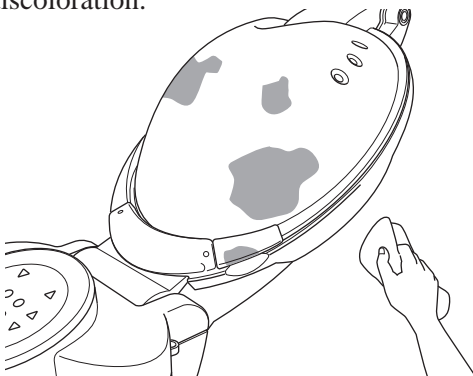

Control Section/Metal Section

Wipe with a soft dry cloth.

Caution

- If water is spilled on this section, wipe it off as soon as possible. Water may cause electrical malfunctions and become a source of breakdowns.

Plastic/Plated Metal/Painted Surfaces Section

Wipe with a soft dry cloth.

Use a diluted neutral detergent to clean off stubborn grime.

Water Container Maintenance

When cleaning out the Water Container using detergent, rinse the tank thoroughly to remove all traces of detergent. Detergent left behind may cause the machine to malfunction.

Notice

Do not use the following substances.

Thinner, alcohol, gasoline, kerosene or other volatile chemicals; waxes containing abrasives; sponges containing abrasives, etc.

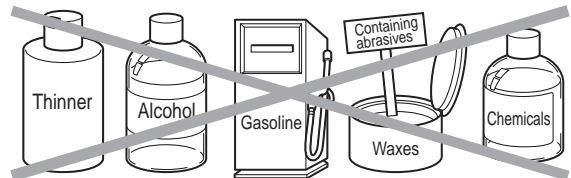

Wash the Face Guard with laundry detergent and use only after drying thoroughly.



Display Codes

The following displays indicate the condition of the machine, follow the directions on the Display decal.



▪ Indicates that warm-up is in progress.



Wait until warm-up has been completed.



▪ Indicates that Cleaning is in progress.



This displays up to 59 seconds after the start of Cleaning.

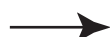

This displays from 1 minute to 1 minute and 59 seconds after the start of Cleaning.



▪ Indicates that the water in the Water Container has run out.

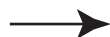

Put water in the Water Container
Operation will resume after water has been added.



▪ Indicates an excess of water.



1. Turn off the Power Switch.
2. Remove the Water Container, and discard the water in the Main Unit.
3. Fill the Water Container with water and check to make sure that there are no leaks.
4. After checking, resume operations.



▪ Indicates a Heater or Temperature Detection Section malfunction.

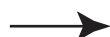

1. Turn off the Power Switch and then turn it on again.





▪ Indicates a Temperature Detection Section malfunction.

2. If the display appears again, contact our service center or sales office.







▪ Indicates a Water Level Detection Section malfunction.

Troubleshooting

Symptom	Check
<ul style="list-style-type: none"> ● No power (Nothing displays on the Control Panel) 	<ul style="list-style-type: none"> ○ Make sure that the power plug is properly plugged into the outlet. ○ Check to make sure that the Power Switch has been turned on. ○ Check the fuses in your fuse box to make sure they haven't burned out. If you have a breaker box, check for tripped breakers. ○ Unplug the machine and then plug it in again and see if it will operate.
<ul style="list-style-type: none"> ● No mist comes out 	<ul style="list-style-type: none"> ○ If the  display is blinking → p. 18 ○ If the  display is blinking → p. 18 ○ If the Mist Level is (1, 2) (→p. 8) There may be cases in which the quantity of mist is so small it is not visible.
<ul style="list-style-type: none"> ● The Temperature is too low or too high 	<ul style="list-style-type: none"> ○ Check to make sure the Temperature Level has been set properly.
<ul style="list-style-type: none"> ● Water leaks from the Discharge Outlet. 	<ul style="list-style-type: none"> ○ Check to make sure the Drain Cock is shut.

In cases other than those listed above, contact our service center or sales office.

 Caution	
 Be careful of use. Children shall not play with the appliance.	 Be careful of use. The appliance is not to be used by children or persons with reduced physical, sensory or mental capabilities, or lack of experience and knowledge, unless they have been given supervision or instruction.
 Be careful of use. Cleaning and user maintenance shall not be made by children without supervision.	

IMPORTER INFORMATION

COUNTRY		REGISTERED PLACE OF BUSINESS & ADDRESS
GBR	Importer in UK	TAKARA BELMONT(U.K.)LTD. BELMONT HOUSE, ONE ST.ANDREWS WAY, BOW LONDON E3 3PA, ENGLAND
DEU	Importeur in Deutschland	TAKARA COMPANY EUROPE GmbH BERNER STRASSE 18, 60437 FRANKFURT/M, GERMANY
FRA	Importateur en France	TAKARA COMPAGNIE PARIS S.A.R.L. 56 rue des Hautes Pâtures 92009 NANTERRE Cedex France
ITA	Importatore in Italia	TAKARA BELMONT ITALY S.R.L. Via Marino Mazzacurati No.4/1, 42019 Scandiano RE, Italy

EU Declaration of Conformity

We hereby declare that the product listed below complies with the essential requirements of the EMC (electromagnetic compatibility) Directive : 2014/30/EU, Low Voltage Directive : 2014/35/EU, Machinery Directive : 2006/42/EC and RoHS Directive : 2011/65/EU based on category 11 of Annex I.

Product : HAIR PROCESSOR

Model : MICRO MIST

The product has been designed and manufactured in accordance with the European standards as the listed in the Declaration of Conformity.

UK DECLARATION OF CONFORMITY

We declare under sole responsibility that the device that is covered by the present declaration is in conformity with the following regulations and, if applicable, with any other relevant UK legislation that provides for the issuing of an UK declaration of conformity.

Product : HAIR PROCESSOR

Model : MICRO MIST

Regulations this product conforms to:

The Electrical Equipment (Safety) Regulations 2016, S.I. 2016/110

The Electromagnetic Compatibility Regulations 2016, S.I. 2016/1091

The Supply of Machinery (Safety) Regulations 2008, S.I. 2008/1597

The Restriction of the Use of Certain Hazardous Substances in Electrical and Electronic Equipment Regulations 2012, S.I. 2012/3032 based on category 11 of PART 1, SCHEDULE I

EU Authorised representative

TAKARA COMPANY EUROPE GmbH

Berner Strasse 18, 60437

Frankfurt am Main, Germany



UK Authorised representative

TAKARA BELMONT(U.K.)LTD.

BELMONT HOUSE, ONE ST.ANDREWS WAY, BOW

LONDON E3 3PA, ENGLAND



TAKARA BELMONT CORPORATION

2-1-1, Higashishinsaibashi, Chuo-ku, Osaka, 542-0083, Japan