

# SPA MIST II

## GUIA DE OPERAÇÃO RÁPIDA

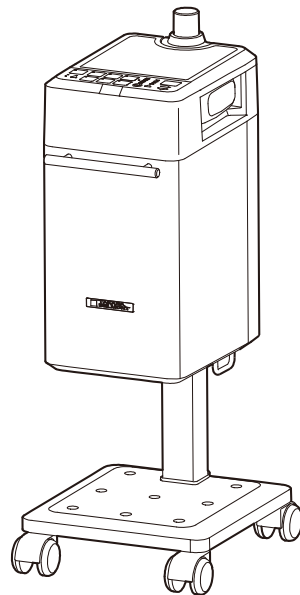



Para detalhes e informações de segurança  
veja as instruções de operação.

<https://beauty.takarabelmont.co.jp/manual-site/>



# 1 Painel de controle

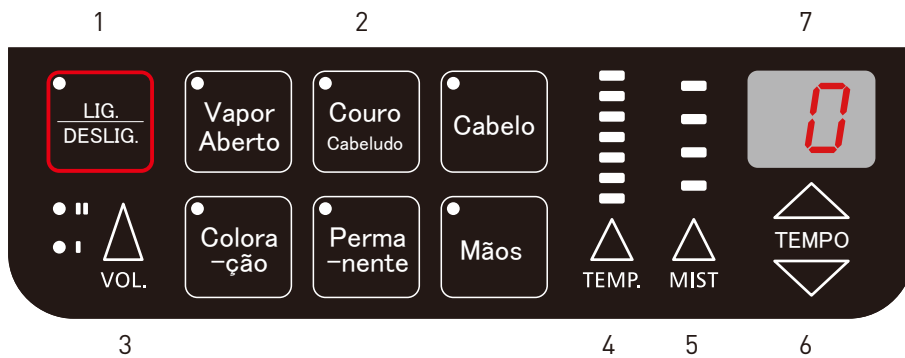

## 1 Tecla LIG/DESLIG



## 2 Tecla de seleção de modo



Xampu/ massagem com agente químico



Tratamento para cabelos ondulados



Tintura de cabelo ácida  
\*Tempo de resfriamento:  
5 minutos



Tratamento dos fios/cabelos



Tratamento do couro cabeludo



Cosmético para cuidar das mãos

## 3 Tecla de volume



Mudo



Nível 1



Nível 2

## 4 Tecla de nível de temperatura

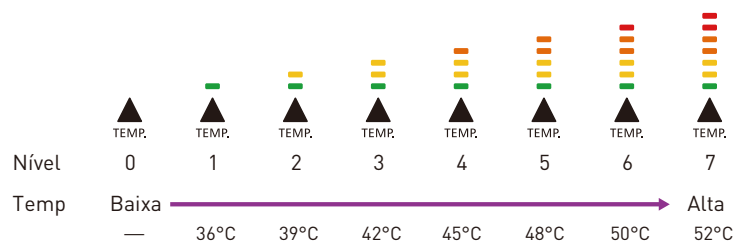

## 5 Tecla de nível de vapor

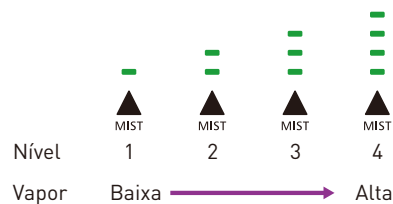

## 6 Tecla de configuração de tempo



## 7 Painel de exibição

Indicação de condição



Indicação de tempo



Indica o tempo restante da fase de resfriamento



Indica falta de água no reservatório de água. Despeje água no reservatório de água.



A máquina tem muita água. Envazie o reservatório interno.



Indica que o pré-aquecimento está em progresso

Indicação de erro



1 - Encaixe a mangueira sanfonada.



2 - Desligue o aparelho 30 segundos e ligue novamente.



3 - Se o erro persistir, ligue para Assistência Técnica.



1 Fixe a junta N da touca à touca de vapor (opção).

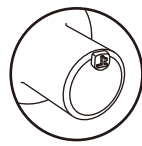
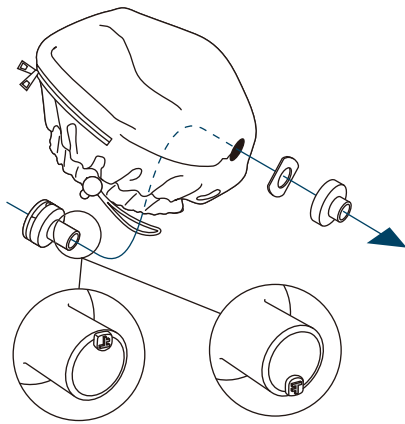

- O bico esférico de vapor aberto
- Lavagem traseira no lavatório
- Cadeira do Salão de Beleza

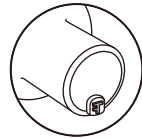

- Cadeira de barbearia

2 Despeje água no reservatório de água.

1. Remova a tampa do reservatório de água e despeje a água.

 **Cuidado**

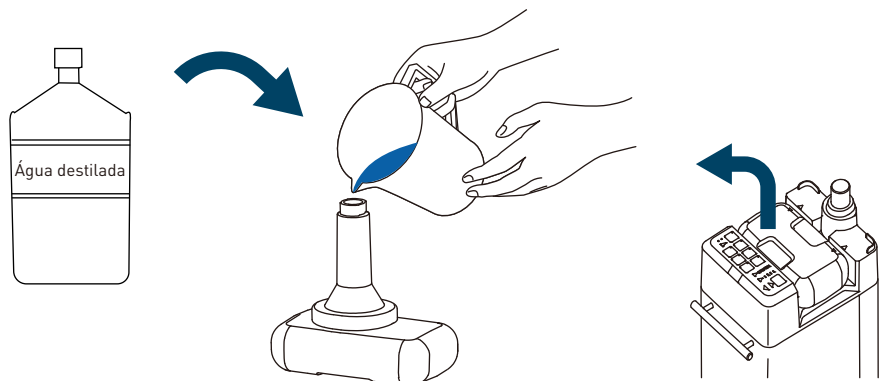

2. Feche a tampa do reservatório de água.

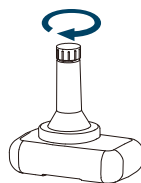

3. Verifique se a torneira de dreno foi fechada e não há mais água no tanque de dreno.

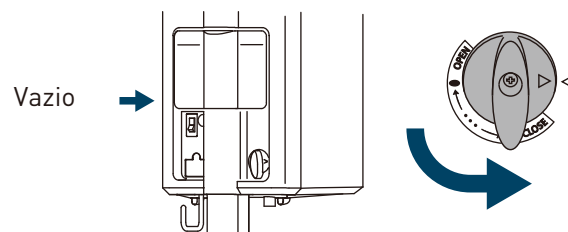

4. Coloque o reservatório de água na parte superior do aparelho.

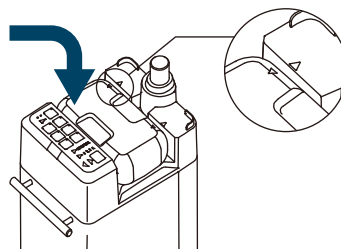

### 3 Procedimentos da operação

1 Insira a mangueira flexível no bico de exaustão.

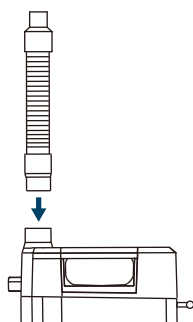
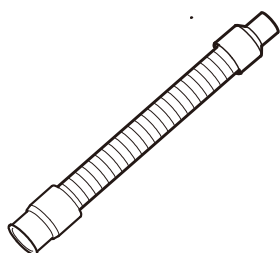

2 Coloque o aparelho atrás do cliente.



3 Conecte e ligue a alimentação.

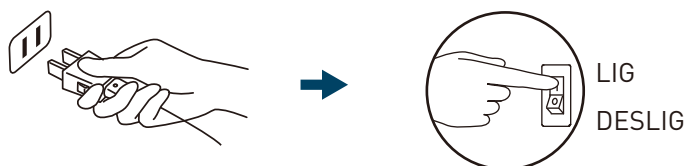

4 Pressione o botão dependendo ao modo desejado.

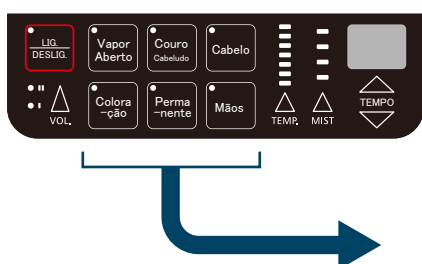

<b>Vapor Aberto</b>	Xampu / Massagem / Lavagem *NÃO use Touca	<b>Perma-nente</b>	Para cabelos ondulados *Use Touca
<b>Colora-ção</b>	Tintura de cabelo *Tempo de resfriamento: 5 minutos *Use Touca de Coloração	<b>Cabelo</b>	Tratamento nos fios *Tempo de esfriamento: 2 minutos
<b>Couro Cabeludo</b>	Cuidado do couro cabeludo *Use Touca	<b>Mãos</b>	Cosmético para cuidar das mãos *Uma tampa opcional pode ser usada.

5 Pressione a tecla liga/desliga para executar o pré-aquecimento.



### 3 Procedimentos da operação

Ajuste a touca de vapor. Insira a mangueira flexível na junta N da touca.

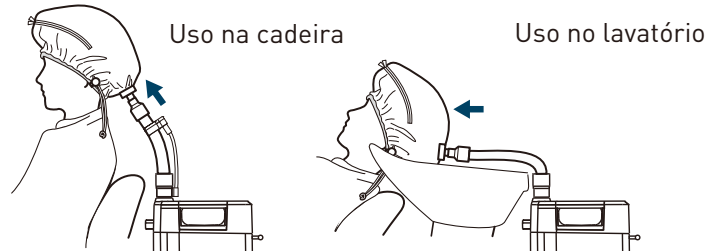
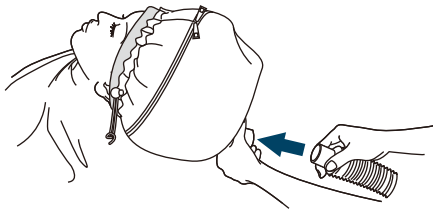

6 Pressione a tecla LIG/DESLIG para iniciar a operação.



7 Durante a operação.

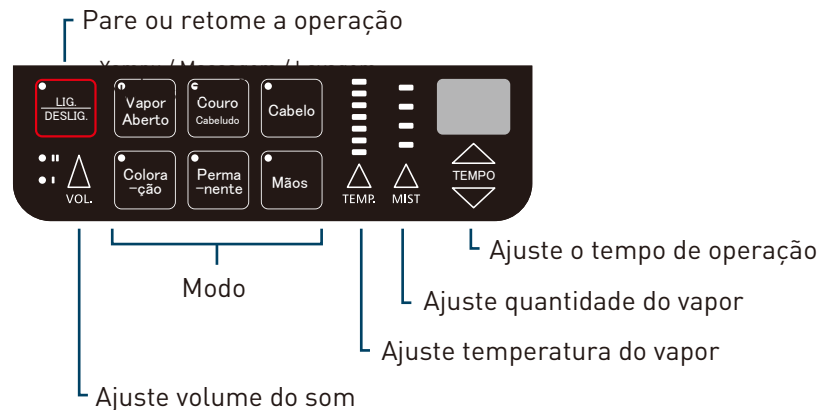

8 Resfriamento.



9 Conclusão.





### 3 Procedimentos da operação

- 10 Desligue a alimentação após ter terminado o trabalho.

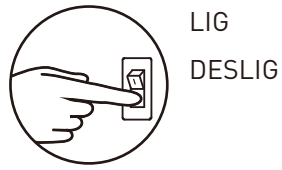

- 11 Elimine a água acumulada no tanque de dreno.

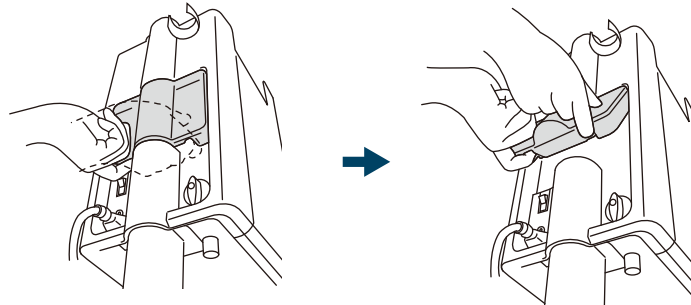

- 12 Drene a água interna no final do dia.

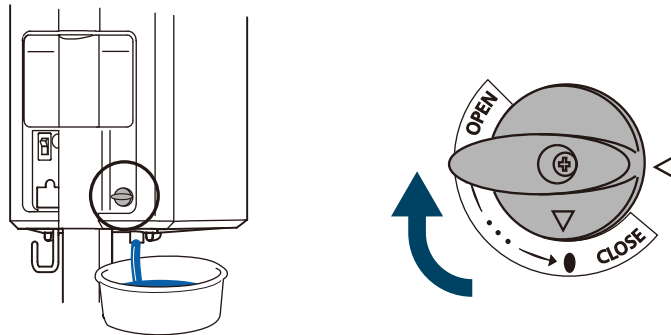

- 13 Acomodação da mangueira flexível.

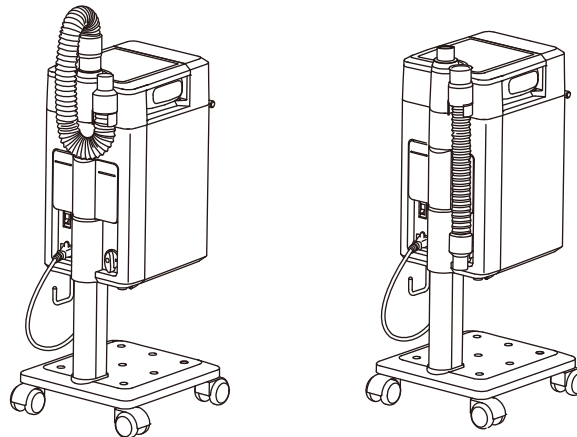

## 4 Colocação/Remoção da touca de vapor

### 1 Uso da cuba do lavatório de cabelo.

#### Colocação da touca de vapor

1

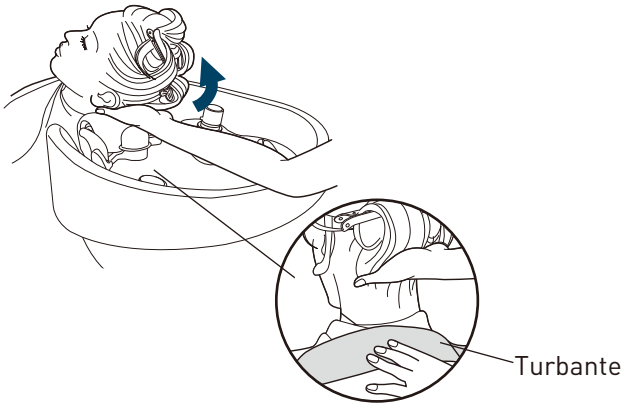

2

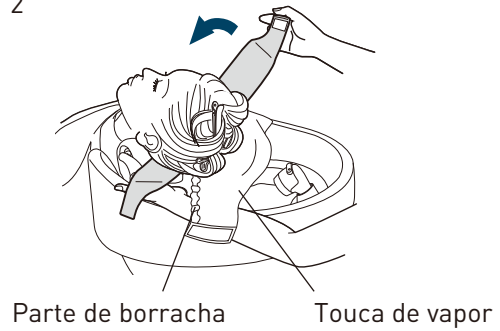

3

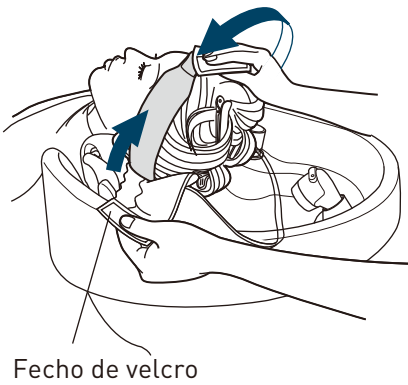

4

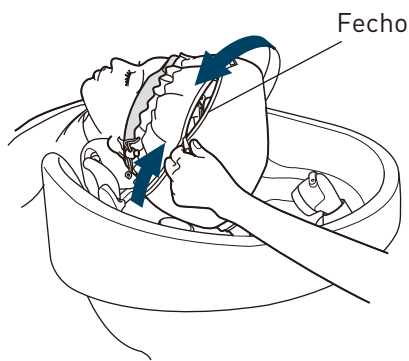

5

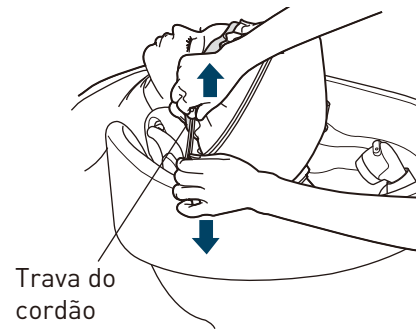

6

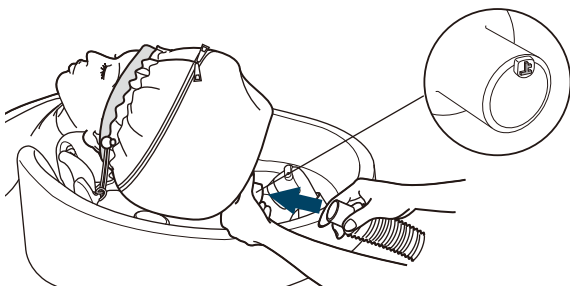

7

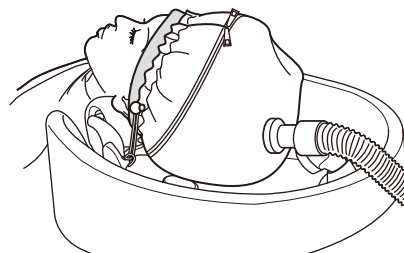

#### Remoção da touca de vapor

1

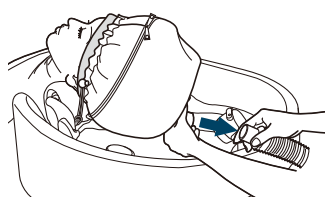

2

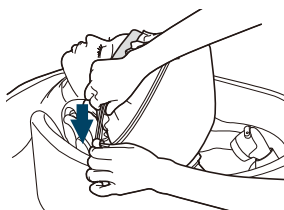

3

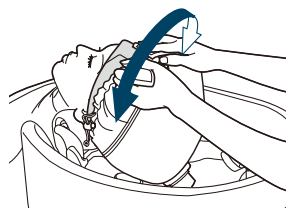

4

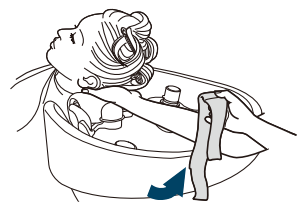

Video

## 4 Colocação/Remoção da touca de vapor

2 Quando se usa a cadeira de cabeleireiro.

### Colocação da touca de vapor

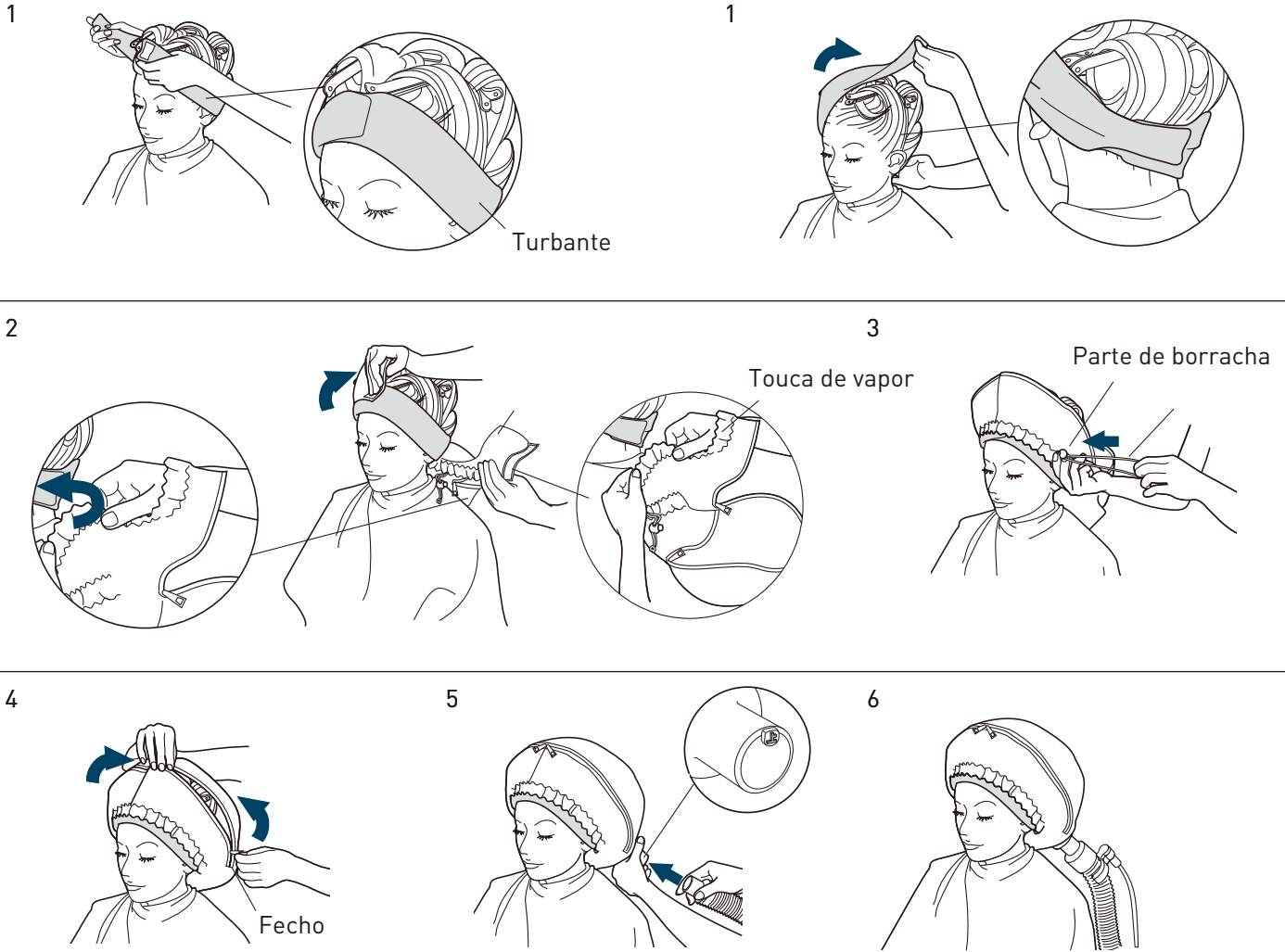

### Remoção da touca de vapor

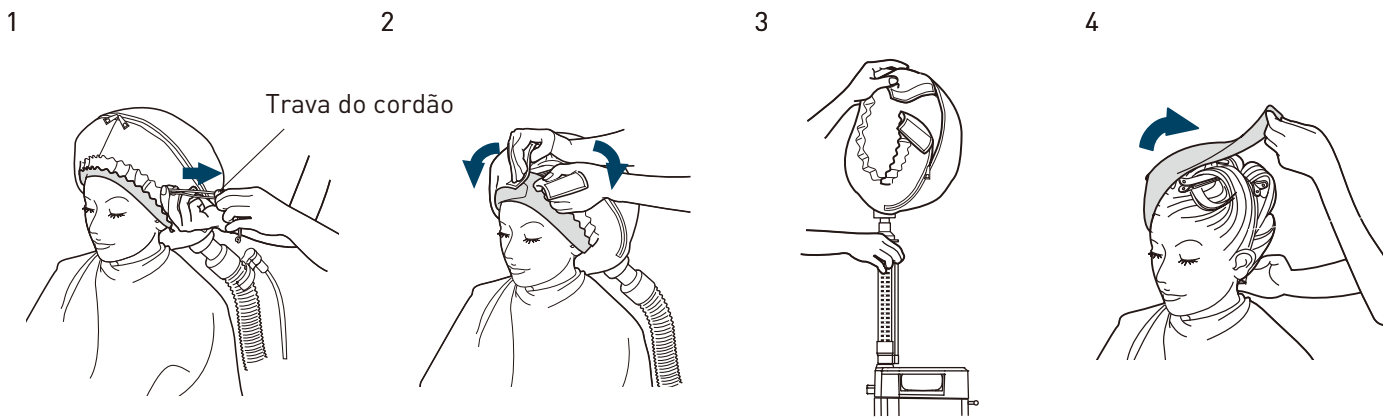

Video



**TAKARA BELMONT CORPORATION**

2-1-1, Higashishinsaibashi, Chuo-ku, Osaka, 542-0083, Japan

TEL : 81-6-6213-5945

FAX : 81-6-6212-3680

