

SPA MIST II

KURZANLEITUNG

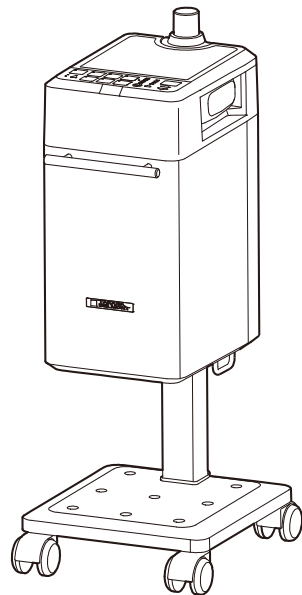

Einzelheiten und Sicherheitsinformationen
finden Sie in der Bedienungsanleitung.

<https://beauty.takarabelmont.co.jp/manual-site/>



1 Schalttafel

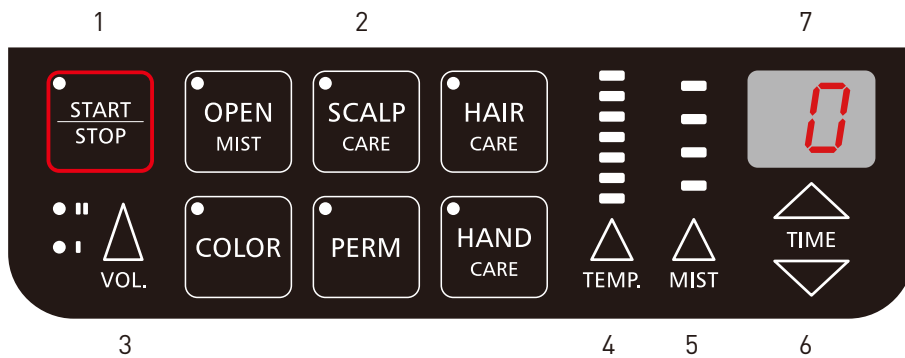

1 Start / Stopp-Taste



2 Moduswahltaste



Shampoo / Massage mit chemischen Mitteln



Dauerwellen / Behandlungen mit Lockenmittel unter Hitze



Saures Färben
*Abkühlzeit: 5 min



Haircare/ Behandlungen unter Hitze/ Dauerwelle



Kopfhautreinigungsmittel
Kopfhautbehandlung



Kosmetik für die Handpflege

3 Lautstärketaste



Stumm



Level 1



Level 2

4 Temperaturstufe Erklärung

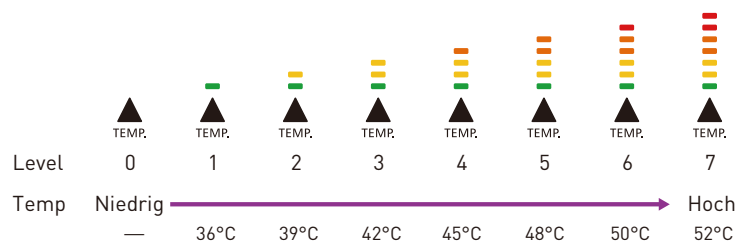

5 Nebelstufe

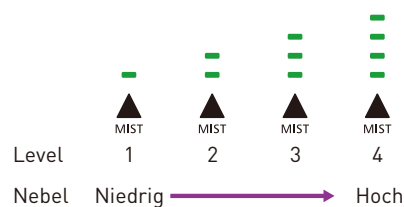

6 Zeiteinstellungstaste



7 Anzeige

Zustandsanzeige



Zeitanzeige



Abkühlen und die verbleibende Zeit



Wassermangel in der
Wasserversorgungsflasche
Destilliertes Wasser nachfüllen



Zu viel Wasser in der Maschine



Vorwärmen

Fehleranzeige



Fehler der Temperaturerfassungseinheit
Heizungsfehler



Fehler der Temperaturerfassungseinheit



Fehler des Wasserstandserkennungsgeräts
Fehler des Schwimmerschalters

2 Vorbereitung

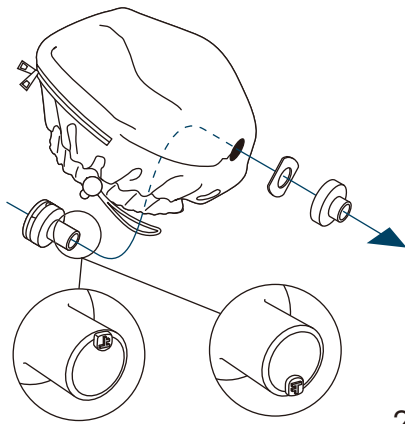

- 1 Befestigen Sie die Kappenverbindung N an der Nebelkappe (Option).

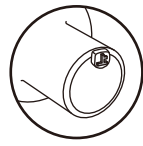

-YUME und offene Nebelkugeldüse
-Rückwaschanlage und YUME
-Styling Stuhl

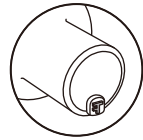

-CALME und Herrenstuhl

- 2 Gießen Sie destilliertes Wasser in die Wasserversorgungsflasche.

1. Entfernen Sie die Wasserversorgungskappe und gießen Sie destilliertes Wasser ein

 **VORSICHT**

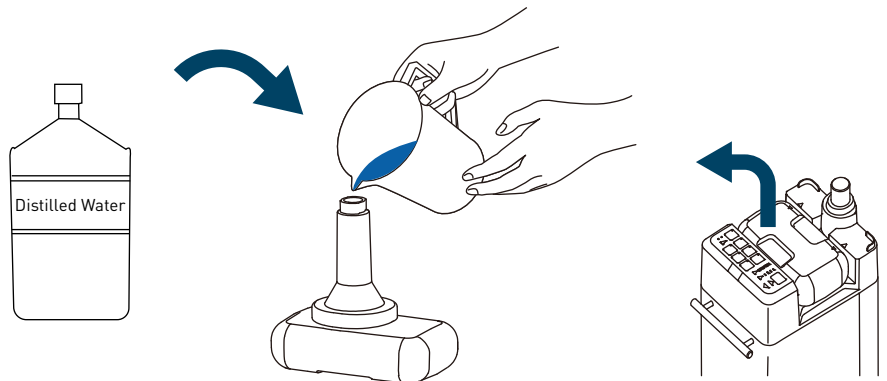

2. Schließen Sie die Wasserversorgungskappe.

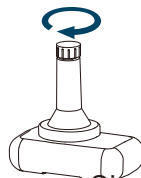

3. Leeren Sie den Ablauftank und stellen Sie sicher, dass der Ablaufhahn geschlossen ist.

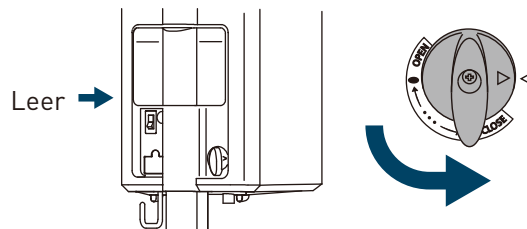

4. Setzen Sie die Wasserversorgungsflasche oben in das Gerät ein.

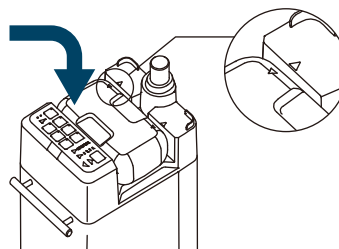

3 Betriebsverfahren

- 1 Führen Sie den flexiblen Schlauch in die Auslassdüse ein.

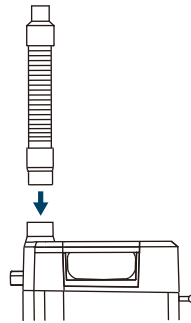
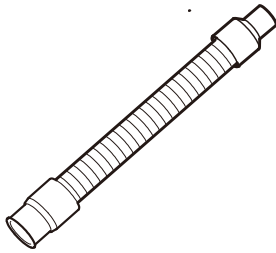

- 2 Stellen Sie das Hauptgerät hinter den Kunden.



- 3 Stecken Sie das Gerät ein und schalten Sie es ein.

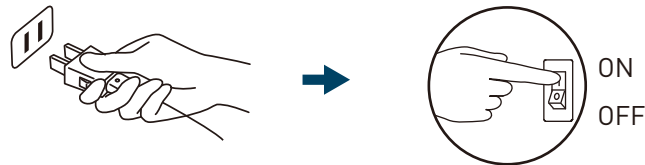

- 4 Drücken Sie die Taste für den gewünschten Modus.



OPEN MIST	Shampoo / Massage mit chemischem Mittel *Verwenden Sie KEINE Nebelkappe.	PERM	Dauerwellen / Behandlungen mit Lockenmittel unter Hitze *Eine optionale Nebelkappe kann verwendet werden.
COLOR	Haarfärbemittel *Abkühlzeit: 5 min *Eine optionale Nebelkappe kann verwendet werden.	HAIR CARE	Behandlung *Abkühlzeit: 2 min *Eine optionale Nebelkappe kann verwendet werden.
SCALP CARE	Kopfhautreinigungsmittel Kopfhautbehandlung *Eine optionale Nebelkappe kann verwendet werden.	HAND CARE	Kosmetik für die Handpflege *Eine optionale Abdeckung kann verwendet werden.

- 5 Drücken Sie die Start / Stopp-Taste, um das Vorheizen durchzuführen.



3 Betriebsverfahren

Setzen Sie die Nebelkappe auf und führen Sie den flexiblen Schlauch in die Kappenverbindung N ein.

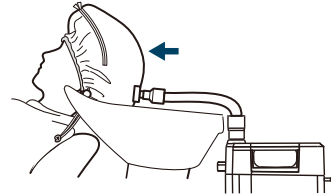
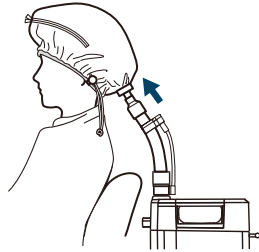
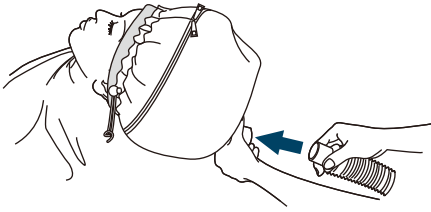

6 Drücken Sie die Start / Stopp-Taste, um den Vorgang zu starten.

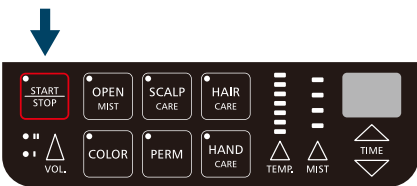

7 Während der Operation.

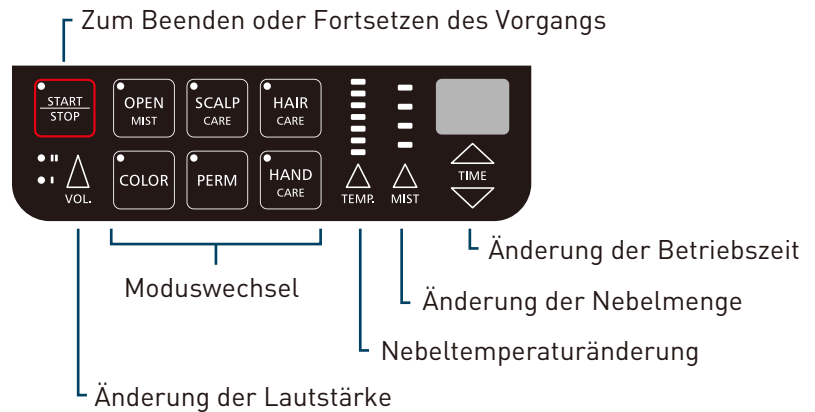

8 Kühlung.



9 Zeit abgelaufen.

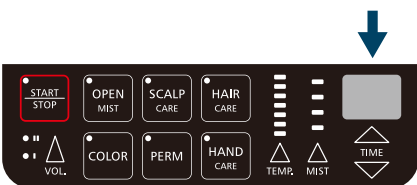

- 10 Schalten Sie die Stromversorgung nach Beendigung der Arbeiten aus.

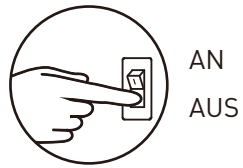

- 11 Entfernen Sie das im Ablauftank angesammelte Wasser.

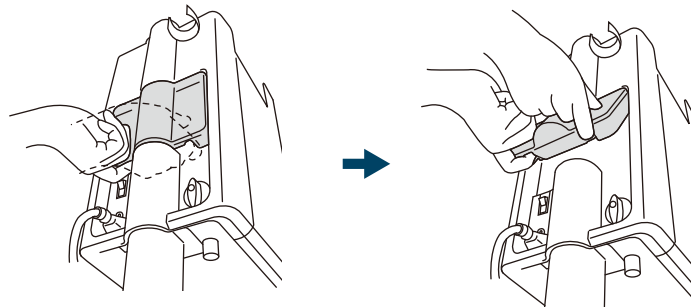

- 12 Lassen Sie den Wassertank nach Gebrauch ab.

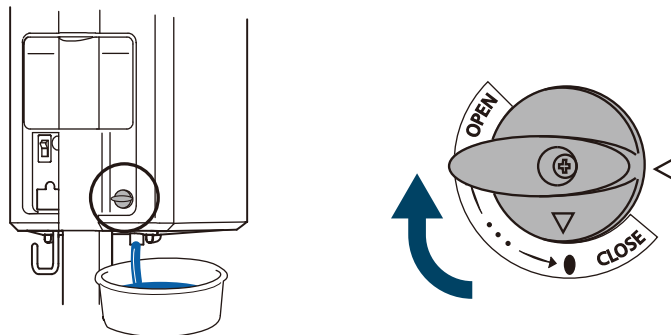

- 13 Unterbringung des flexiblen Schlauchs.

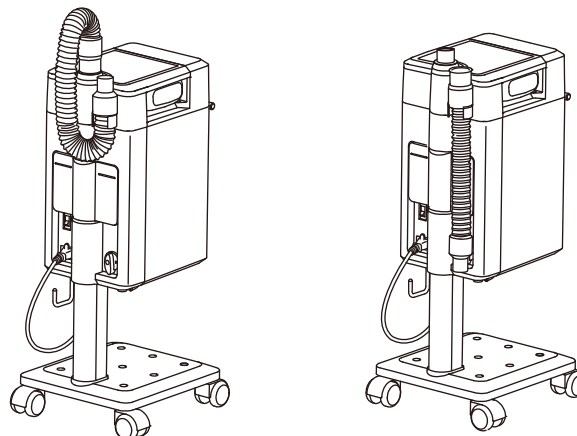

4 Aufsetzen / Entfernen der Nebelkappe

1 Bei Verwendung an einer Rückwaschanlage.

Aufsetzen der Nebelkappe

1

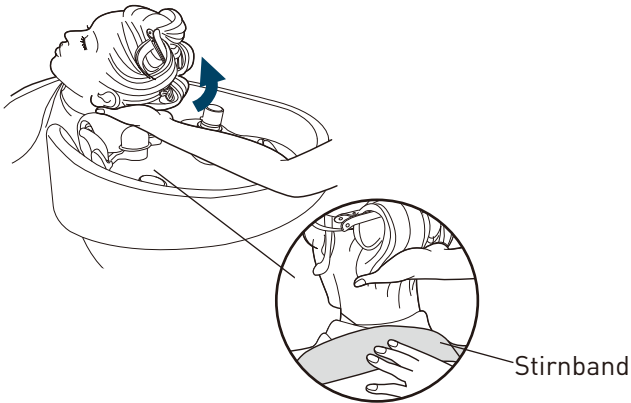

2

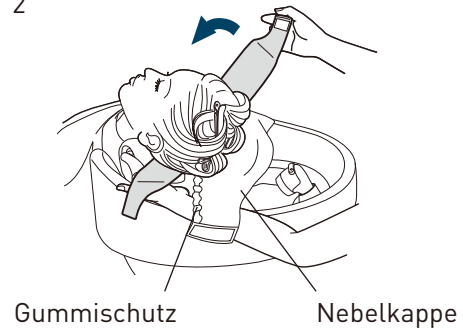

3

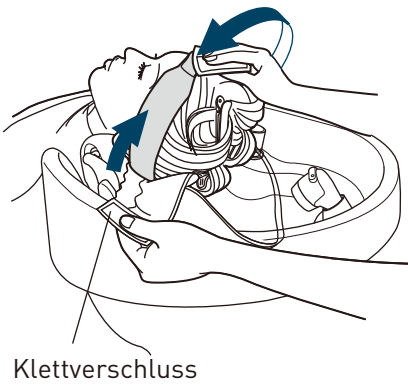

4

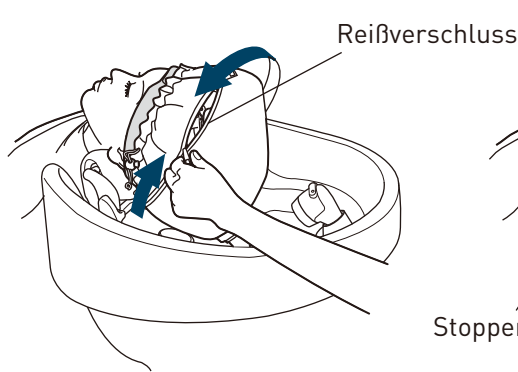

5

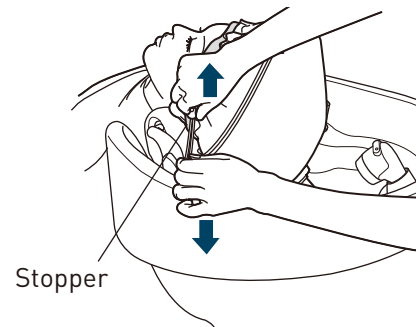

6

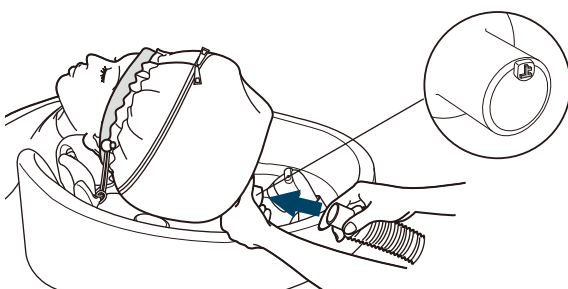

7

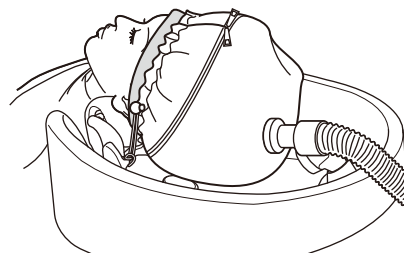

Entfernen der Nebelkappe

1

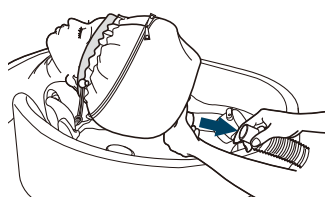

2

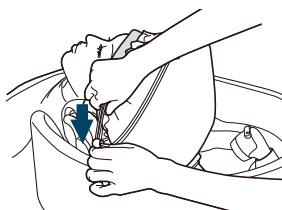

3

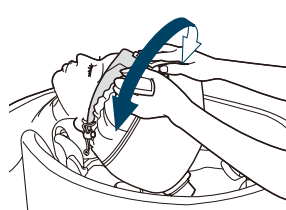

4

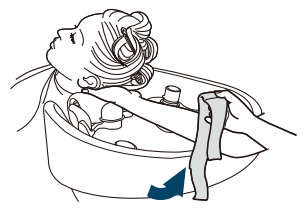

Video

4 Aufsetzen / Entfernen der Nebelkappe

2 Bei Verwendung an einer Stylingstation.

Aufsetzen der Nebelkappe

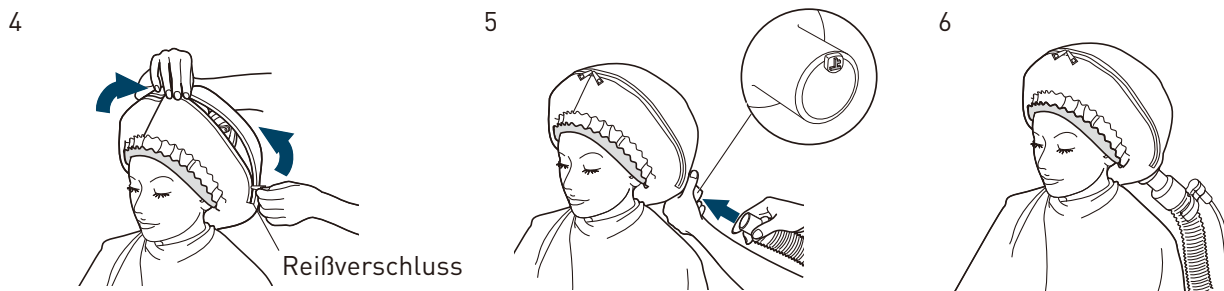
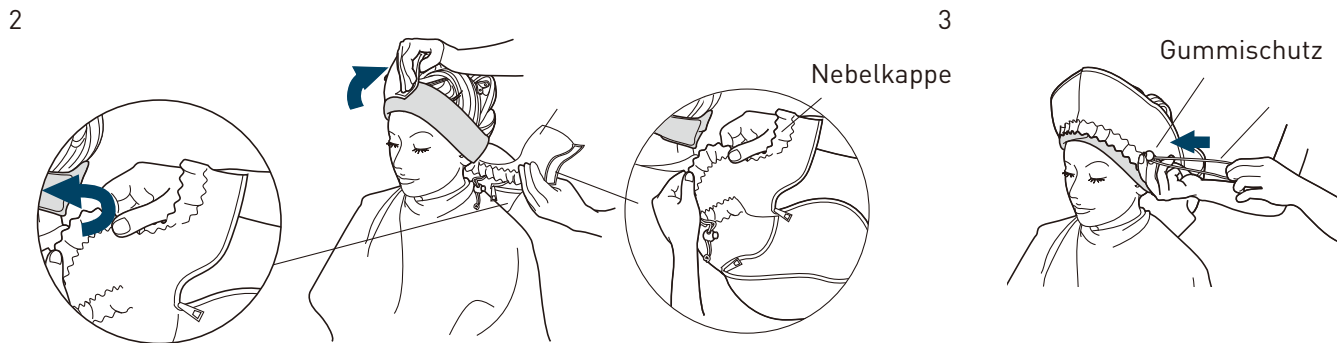
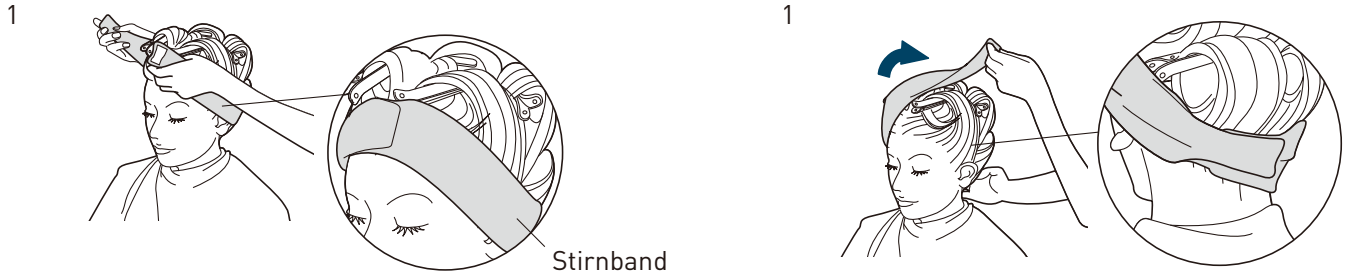

Entfernen der Nebelkappe

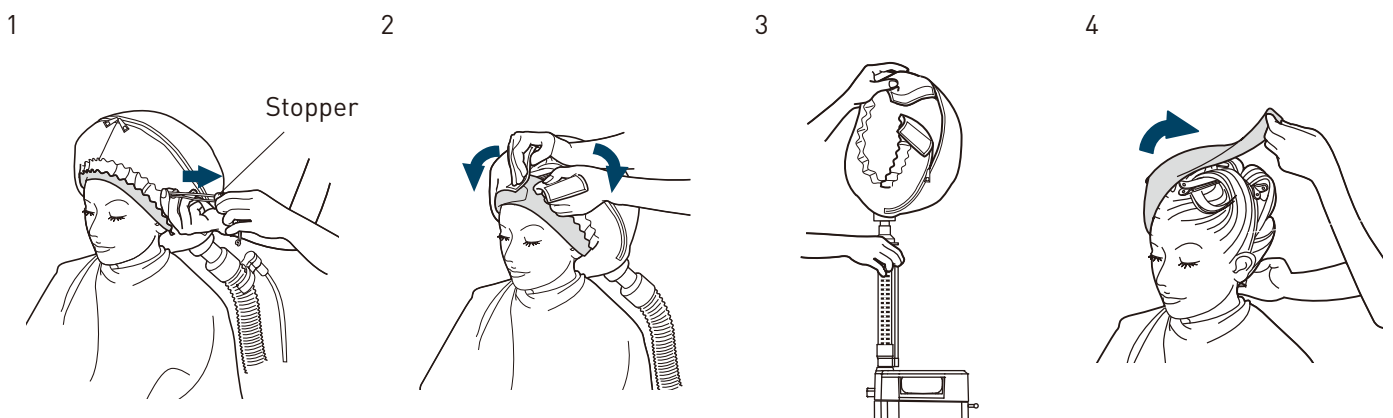

Video



TAKARA COMPANY EUROPE GmbH

Berner Strasse 18, 60437
Frankfurt am Main, Germany
TEL : +49-69-506878-0
FAX : +49-69-506878-20



TAKARA BELMONT CORPORATION



2-1-1, Higashishinsaibashi, Chuo-ku, Osaka, 542-0083, Japan
TEL : 81-6-6213-5945
FAX : 81-6-6212-3680