

LEGEND

Model No. AB-LGS AB-LGL
 AB-LGP AB-LGF
 AB-LGSX AB-LGLX

Operation Manual

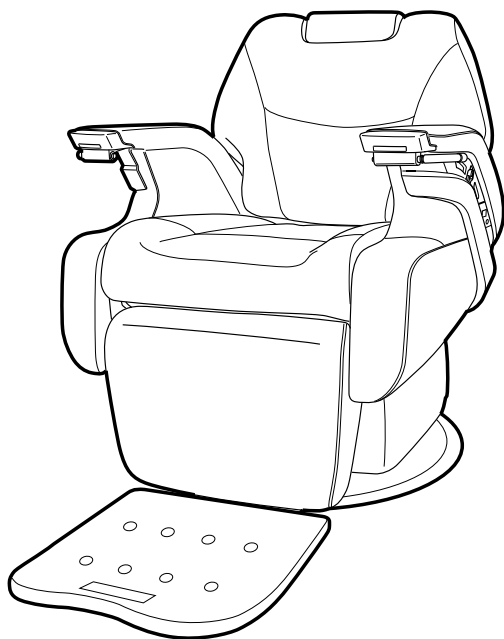

Takara Belmont would like to thank you for purchasing this Takara Belmont product. Be sure to read this operation manual before operating the chair and always operate the chair properly according to the instructions herein. Failure to read this operation manual may lead to accidents. This product is designed for commercial use in barber shops and beauty salons. Do not use this chair for any applications other than hairdressing/beauty-related procedures. Store this operation manual in a secure location and refer to it whenever necessary.

Please inform Takara Belmont of the book number on the back cover to obtain a new operation manual if this operation manual becomes torn or damaged and unreadable, or is lost.

Table of Contents

SAFETY PRECAUTIONS (MUST BE OBEYED)	2
NOTES FOR USE	8
LOCATIONS OF WARNING LABELS	9
NOTES RELATED TO SYNTHETIC (NATURAL) LEATHER	9
ACCESSORIES	9
NAME OF COMPONENTS	10
PREPARATION	12
Power Supply	12
HOW TO USE	
(1) Guiding Customers	14
(2) Raising/Lowering the Chair	16
(3) Reclining/Raising the Backrest	17
(4) Using Sheat arrange mode (AB-LGSX,LGLX)	22
(5) Using Preset Functions	24
(6) Removable Step	26
(7) Heater (AB-LGP,LGF)	27
(8) Accumulator (AB-LGP,LGF)	27
(9) Dryer/Iron Holder	28
(10) Service Outlets (Type C Specification)	29
(11) Foot Cushion (AB-LGF)	29
CARE AND MAINTENANCE	30
DAILY INSPECTION	31
BEFORE REQUESTING REPAIR	32
DAILY INSPECTION PROCEDURES	34
SPECIFICATIONS	37
STANDARD PERIOD OF USE	39
DISPOSING OF THIS PRODUCT	39
DECLARATION OF CONFORMITY	39
INTENDED USE OF THE PRODUCT	39

SAFETY PRECAUTIONS (MUST BE OBEYED)

■ Before Use

Be sure to thoroughly read these precautions related to safety and operate the chair accordingly in a safe manner.

■ User Prohibitions of this Product

Only persons who are certified hairdressers or beauticians can be allowed to use this chair.

■ About the Precautions Listed Here

The precautions continued herein are in order to ensure safe use, and to prevent any injury to users and other persons, and to prevent any damage.



All these precautions describe important items related to safety. Be sure to always obey all the precautions contained in this manual.

Takara Belmont has absolutely no responsibility for accidents that might be caused by failure to obey "Safety Precautions" and "Notes for Use" resulting in injury to users and other persons, or other damage.

In such cases, the responsibility of any injury and damage lies solely with the user who fails to obey such precautions.

A detailed explanation of the cautionary symbols is provided below.

Be sure that you fully understand their contents before reading the rest of this manual.

Classification of Precautions	Level of Harm and Damage, and Degree of Urgency
 WARNING	This indicates that failure to obey the corresponding warning and the resulting improper operation can result in death or serious injury.
 CAUTION	This indicates that failure to obey the corresponding warning and the resulting improper operation can result in mild injury, or moderate harm and damage.
NOTICE	This indicates a recommended action that should be performed in order to ensure safety.

WARNING

Use a single outlet (do not share an outlet with other plugs).

Use an unshared * outlet with an attached ground terminal. Using the same outlet together with the power plug of other devices can result in abnormal heat generation and possible fire.* 230V AC (12 A or more)

Be careful of power cord or plug breakage.

Do not use any power cord or plug that is damaged, or that fits loosely when inserted into an outlet. Doing so can result in electric shock or fire.

Unplug the power plug when the chair is not in use.

Turn off the power switch and remove the power plug from the outlet when the chair is not in use. Unexpected operation can result in an accident or fire from a short circuit due to insulation aging.

Securely connect to ground.

Failure to make a ground connection can result in electric shock if there is a malfunction or short circuit. Consult an electrician for grounding procedures.

Do not sit on the backrest of the chair.

Sitting on the backrest of the chair could cause it to tip over, resulting in injury or damage.

Do not disassemble or repair the chair.

Disassembly or repair must only be done by a qualified service staff. Disassembly by yourself can result in an accident, a malfunction, electric shock or fire.

SAFETY PRECAUTIONS (MUST BE OBEYED)

WARNING

Power cord replacement must be performed by a certified person.

Power cord replacement must be performed by your closest dealer, Takara Belmont or a technician with equivalent certification.

Consult an electrician for wiring work.

Wiring work must be performed by certified personnel. Consult an electrician for wiring work.

Firmly insert the power plug into the outlet.

Be sure to fully insert the power plug into the outlet until reaching the base of the plug. Failure to fully insert the plug or similar fault can result in a short circuit or heat generation that causes a fire.

Be careful to keep hands, fingers and other body parts of the customer and user from touching or getting close to moving parts.

There is a danger of pinching and other physical injury.

Hold by the power plug when unplugging.

Do not pull the cord to remove the power plug from the outlet. Hold by the power plug at the end of the cord when removing. Removing the plug by pulling the power cord can damage the power cord, resulting in electric shock or fire.

Do not wash the chair by pouring water on it.

This chair is an electronic device. Do not sprinkle with water to clean it. Washing in such a manner can result in a malfunction or electric shock.

Do not connect the earth (ground) to the following objects.

- Water Pipes
Complete grounding is not possible as hard plastic pipes are widely used.
- Gas Pipes
Connecting to gas pipes can result in an explosion or fire.
- Lightning rods and telephone dedicated grounding wire

Installation precautions

- Installation of this chair must be performed by specialized personnel (personnel from Takara Belmont or Takara Belmont specified representative).
- The chair must be installed on a perfectly flat and solid floor.
- Installing the chair to a location with an angle of 5° or more can result in the chair tipping over.

Do not use in an environment where there are electromagnetic interference waves.

Using this chair in an environment where there are electromagnetic interference waves can cause faulty operation. Do not install the chair near equipment that generates electromagnetic waves such as communication equipment and elevators. Do not use devices that generate electromagnetic waves (such as mobile telephones) near this chair.

Precautions when getting in and out of the chair

Always be sure to lower the chair to the lowest position and lock the rotation when a customer is getting in or out of the chair in order to ensure safety. Be especially careful when moving a person in a wheelchair in and out of the chair, and make sure that the wheelchair is not positioned in the operating range of the chair when moving the person. Feet, casters or other parts contacting the UP/DOWN foot switch will cause sudden operation of the chair, resulting in injury or damage.

SAFETY PRECAUTIONS (MUST BE OBEYED)

WARNING

Precautions for the surrounding area during chair operation

Before and during operation, thoroughly check that there are no bodies or limbs of persons, or possible obstacles in the operating range of the chair (ranges of seat raising/lowering, backrest reclining/raising, chair rotation, legrest operation) or nearby. There is a danger of body parts being pinched by the chair, resulting in injury or damage.

Precautions when changing the preset positions

- Before and while setting the preset positions, thoroughly check that there are no bodies or limbs of persons, or possible obstacles in the operating range of the chair or the area around the chair. There is a danger of body parts being pinched by the chair, resulting in injury or damage.
- The legrest moves in conjunction with the backrest. When changing the preset positions, be very careful that the step or the customer's feet will not contact any nearby equipment or other items.

Precautions after changing the preset positions

After changing the settings of preset positions, thoroughly check that there are no bodies or limbs of persons, or possible obstacles in the operating range of the chair or the area around the chair. There is a danger of body parts being pinched by the chair, resulting in injury or damage.

Only sit in the area designated for such use.

Never sit on the headrest, armrests, edge of the backrest, legrest or step, or subject these to an excessive (more than necessary) load or force with the backrest reclined. Doing so can result in the chair tipping over or being damaged.

Do not stand on the edge of the step.

Do not stand on the edge of the step. Doing so could cause the chair to tip over or the step could suddenly move, resulting in injury or damage.

Precautions regarding customers and children

Be careful to closely watch customers (especially children) in order to make sure that they do not accidentally cause chair operation, resulting in an unexpected accident.

Do not allow a customer to lie face down on the chair.

Do not allow a customer to lie face down on the chair. Sudden operation of the chair can result in injury.

Precautions when reclining/raising the backrest

- The space between the backrest and seat becomes narrow when the backrest is reclined. Check that the customer's hands, arms or clothes are not caught between the backrest and seat before reclining the backrest. There is a danger of body parts being pinched by the chair, resulting in injury.
- Carefully recline the backrest so that the headrest or backrest will not contact any shampoo bowl or nearby equipment.
- When you recline the backrest without using the headrest, support the customer's head with your hand so that the customer will not contact with the shampoo bowl.
- Before raising the backrest, check that the customer's arms or hands are not in between the backrest and armrests, and operate it safely.

SAFETY PRECAUTIONS (MUST BE OBEYED)

WARNING

Precautions during chair rotation

- When rotating the chair with a customer seated, always make sure that the customer is seated completely before rotating the chair.
- Always be sure that no other persons are in the surrounding area before rotating the chair, and rotate so that the step and other parts do not contact the customer or any nearby equipment. Be especially careful of the position of a reclined customer, and the customer's body, hands and feet when the backrest is reclined. Check that the safety of the customer is ensured before rotating the chair.
- Be careful that the adjuster under the step does not contact or catch on the power cord.
- Be sure to always lock (secure) chair rotation by using the rotation lock switch after rotating the chair. Always be sure that the chair rotation is locked before moving the chair. There is a danger of injury or damage if the chair rotates suddenly.
- Always be sure to lock the chair when not rotating it.

Procedures if a power outage occurs

- Turn off the power switch and remove the power plug of this product from the outlet in order to prevent unexpected operation when recovering from a power outage. Also turn off the power switches of all devices connected to the service outlet and remove the power plugs of devices.
- Be extremely careful if there is a power outage when the seat is in a high position such as for shampooing as it is not possible to lower the chair. Assist the customer in getting in and out of the chair in that position, being very careful that the customer is not injured and the chair does not tip over.

Precautions when raising or lowering the chair

Before raising or lowering the chair, always be sure to check that there are no persons or objects near the chair or step, under the armrest or in the gap of the support arm and so on. There is a danger of body parts being pinched, resulting in injury or damage.

Procedures for using removable step

- After installing the step, check that the step fixture is securely held by the guide, the plating Flange nuts(M6) are inserted in the insertion holes, and the step is not loose. Be careful that there is no looseness as this could result in instability when the customer is getting in and out of the chair, and in rubbing against the upper surface of the step when the legrest is raised.
- When installing and removing the step, always make sure that the legrest is raised. (AB-LGS,LGL,LGP)
- Be careful when lifting and carrying the step, and of where you place it because the step is heavy. Dropping the step could result in serious injury.

Precautions for using heater

The heater light is lit up in orange when the heater is operating. Be careful that using the heater for an extended period causes the temperature to increase, possibly resulting in burns or fire.

Only persons who are certified hairdressers or beauticians can be allowed to use this chair.

This chair is specially designed for providing procedures and services of indoor hair salons or esthetic salons. It can only be used by trained professional hairdressers, or by staff under the supervision of a trained professional hairdressers.

SAFETY PRECAUTIONS (MUST BE OBEYED)

WARNING

Do not let children play with the chair.

This chair is specially designed for providing procedures and services of indoor hair salons or esthetic salons. It can only be used by trained professional hairdressers, or by staff under the supervision of a trained professional hairdressers.

Do not let children fix or clean the chair.

Do not let a person unfamiliar with handling with the chair (lack of experience and skills), such as children fix or clean the chair. Doing so can result in an accident or injury.

Always perform daily inspection.

Perform daily inspection according to the "Daily Inspection Procedures". Using the chair without performing daily inspection can result in malfunction or accident.

CAUTION

Do not strongly strike or scrape the chair.

Doing so can result in tearing of covers and similar damage, and faulty operation. In particular, striking or strongly pushing plastic parts such as the backrest cover, the armrest control panel, and the pump cover can result in deformation or breakage.

Make sure that no feet or hands, or other objects will be pinched between the step and floor when raising/lowering or rotating the chair.

Turn off the power switch after you are finished using the chair.

Turn off the power after use. Always operate the power switch by your hands only.

Do not allow any person whose weight exceeds 135 kg/300 lbf to sit in the chair.

Doing so can cause the chair to tip over or faulty operation.

Do not place any objects on top of the power cord.

Do not place any objects on top of the power cord. Damage to the power cord can cause a severed wire or short circuit, resulting in electric shock or fire.

Be careful that the power cord is not caught up by your feet or legs.

Before operation, confirm that every part is working normally and safely.

Be constantly careful of and inspect for looseness, rattling, tilting, vibration, noise, odors and other possible problems. If you feel that something seems slightly different or not normal, immediately stop using the chair, and contact your closest dealer or Takara Belmont.

Immediately wipe off any chemical solutions or water that spills on the chair.

Chemical solutions can become a stain, and their adhering to an electrical part can cause faulty operation or short circuit. Immediately wipe off any grime or other foreign material that has adhered to the chair by using a dry soft cloth.

Be extremely careful not to mistake the switches when operating.

The person operating the chair must pay careful attention to the surrounding area and give verbal warning and not mistake the operation of the chair.

SAFETY PRECAUTIONS (MUST BE OBEYED)

CAUTION

Precautions for using Dryer/Iron Holder

- Be careful that the dryer or iron does not contact the legs or other body parts of the customer when using the dryer/iron holder.
- Always be sure to store the holder under the body after use so it does not interfere with work.
- Do not rotate the dryer/iron holder with a hand dryer or iron still inserted in the slot. Doing so can damage the chair, and the heat can cause deformation or other damage.
- The dryer/iron holder can withstand a load of up to 50 N (5 kgf).

Precautions for cleaning procedures

Do not use any of the following substances to clean the chair.

Thinner, alcohol, nail polish remover, volatile chemicals (such as gasoline or kerosene), acid or alkaline solutions, chlorinated cleaners, disinfectants that are highly corrosive to metal, povidone iodine (iodine solution), sodium hypochlorite, waxes containing abrasive compounds, sponges containing abrasive compounds and similar substances.

Do not use brushes, scouring brushes or similar items when cleaning the chair. Using them will damage the chair or result in the inability to clean off the dirt or grime.

Precautions for using headrest

Be careful when operating the headrest that fingers and other body parts are not pinched between the area around the headrest storage lever (or headrest operation button) or in between the backrest.

Do not pull up the headrest more than necessary.

Be careful because doing so will make the headrest to completely come off the chair.

Precautions for adjusting the adjuster

When adjusting the adjuster, be careful that the adjuster does not rub the floor or catch on the power cord in rotating the chair.

Adjust the adjuster so that the chair does not tip over when stepping on the step.

Precautions when using the cape holder

- Do not apply excessive force to the cape holder as it can only withstand a load of 10 N (1 kgf/2.2 lbf).
- Be sure to always return it to the stored state when not in use.
- When storing the cape holder, be careful not to pinch the customer's or user's fingers between it and the armrest.
- When using and storing the cape holder, please rotate the cape holder with hand.

Unplug the power plug during installation of the chair and parts replacement.

Unplug the power plug during installation of the chair and parts replacement. Failure to do so can result in an accident or injury.

Observe the following precautions when tilting the seat

- Do not raise the seat with the backrest reclined.
- Make sure the chair is properly adjusted for children before letting a child sit on it.

NOTES FOR USE

CAUTION

Immediately wipe off any chemical that spills on the chair.

Immediately wipe off any chemicals adhering to the leather or pump cover.

Do not place any objects other than persons in the seat.

Do not place any objects other than persons in the seat. Doing so can result in deformation or tearing of the leather, or corrosion.

Do not apply heat.

Do not apply heat to the chair. Failure to do so can result in deformation or discoloration.

Recline the backrest at the end of the day.

When you have finished working for the day, lower the chair to the lowest position and completely recline the backrest. This helps to extend the service life of the chair by not applying a load to springs and cylinders.

NOTICE

The maximum load of this chair is 1,350 N (135 kgf/300 lbf). The raising speed of the seat declines as the maximum load is approached.

Contact your closest dealer or Takara Belmont if the breaker function (P. 32) frequently operates.

Discoloration of resin

Resin materials are used in external components of this product.

Carefully selected materials are used; however, discoloration may occur for reasons such as natural deterioration or the adherence of solutions. To ensure use of the product for longer period, immediately wipe off any solutions if it adheres, and avoid sunlight.

SAVE THESE INSTRUCTIONS

LOCATIONS OF WARNING LABELS

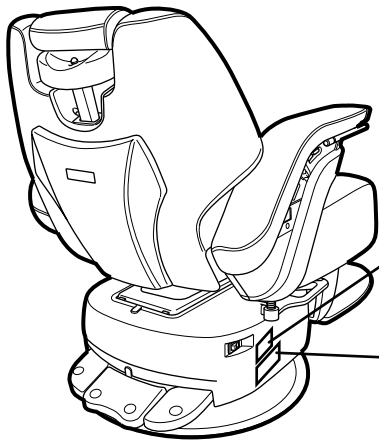

⚠ WARNING / AVERTISSEMENT		
For public occupancy use only.	This furnishing has not been evaluated for flammability or cigarette ignition resistance.	Warning risk of injury maximum load 300 pounds.
Pour usage publique seulement.	Cet ameublement n'a pas été évalué pour les tests de flammabilité et de résistance à l'ignition par une cigarette.	Danger /Risque de blessure/ Charge maximale 300 lbs.
Refer to the Operation Manual for other notes.		

⚠ WARNING / AVERTISSEMENT			
Risk of pinching during the operation. Check the space below and around the chair when raising or lowering the chair and the legrest. Risque de pincement durant l'opération. Vérifier l'espace en dessous et autour de la chaise lors de l'élévation ou de la descente de la chaise ainsi que du repose jambes.	Risk of dropping of the pump. Carry the chair with holding the base and the foot pedal. Risque d'échapper la pompe. Transporter la chaise en soutenant la base et la pédale.	Risk of malfunction or a fire caused by a short circuit. Unplug the power cord when not used. Risque de malfonction ou incendie causée par un court-circuit. Débrancher le cordon d'alimentation lorsque non-utilisé.	Risk of electric shock, fire, and abnormal motion. Do not disassemble, repair or modify. Risque de choc électrique, incendie ou opération anormale. Ne pas désassembler, réparer ou modifier.
Refer to the Operation Manual for other notes.			

NOTES RELATED TO SYNTHETIC (NATURAL) LEATHER

- Clothing dye adhering
The color of clothing or belts can be transferred to the synthetic leather of this chair by means of contact. If color adheres to the leather, wipe off the stain as soon as possible by using a soft cloth that has been dabbed with a neutral detergent diluted with water to approximately one tenth in order to prevent the stain from soaking in due to the plasticizer. Wipe the area with a dry cloth after wiping off the color.
- Precautions regarding deformation and color transfer due to contact
 - Contact with other plastic parts, painted items, solvents, adhesive tape and similar items can result in changes in surface luster, cracking, deformation and peeling.
 - Contact with newspaper or other printed items can result in color transfer.
 - Contact with printed clothing such as t-shirts, jeans and similar items can result in color transfer such as by dye adhering to the leather.
 - Contact with benzene, nail polish remover, alcohol and similar substances can result in discoloration, surface or plasticizer dissolution, changes in luster, hardening or softening, or peeling.
 - Use of bleach, or use of a sheet or other cloth for which bleach has been used can result in changes in luster and color.
 - Placement of an iron, heater or other excessive heat source near the chair can result in deformation and discoloration.
 - Use a curtain or similar item to block the chair from exposure to direct sunlight. Exposure to direct sunlight can result in surface deformation, shrinking, discoloration, faded colors and similar problems.
 - Placement of a heavy item for an extended period can result in marks or wrinkles that do not disappear after removing the item.

ACCESSORIES

- Operation manual (this manual)
- Installation manual
- Step (with adjuster)
- Rubber ring
- Foot cushion(AB-LGF)

NAME OF COMPONENTS

■ Main Unit

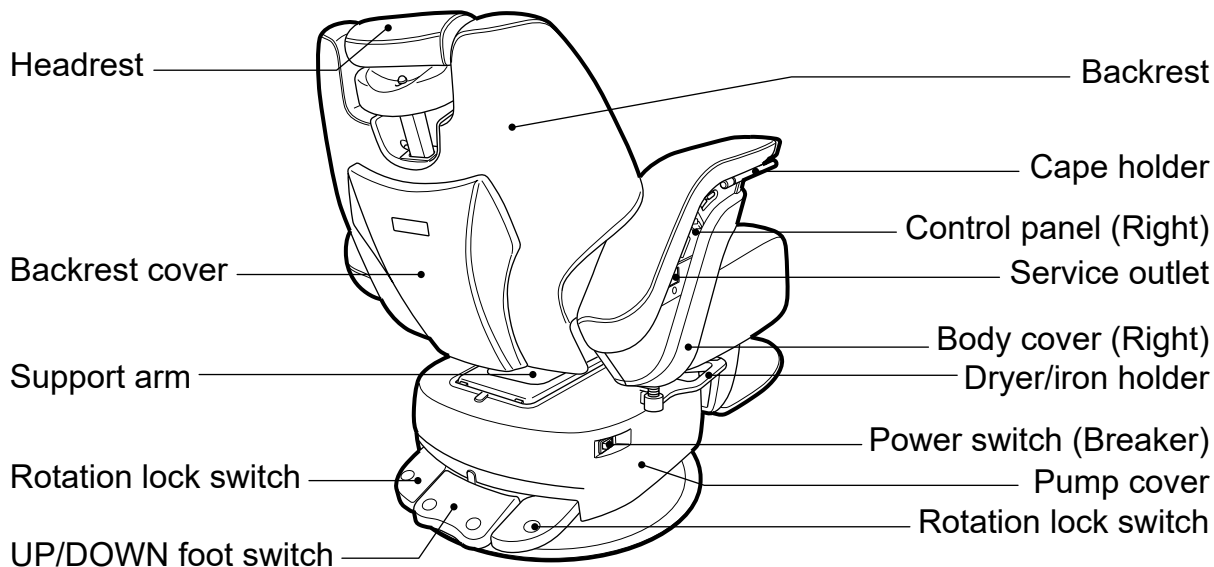
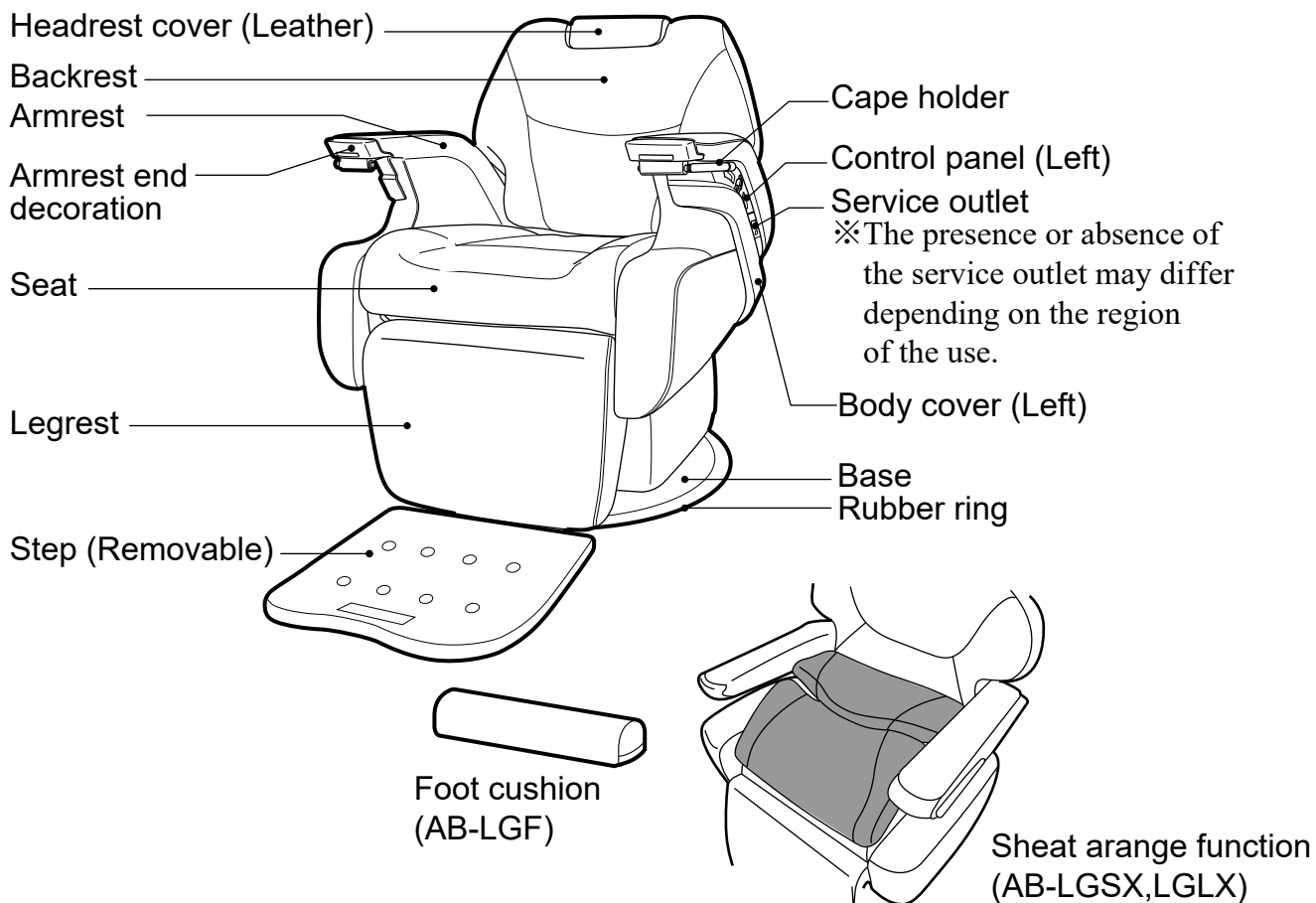

■ Normal Headrest

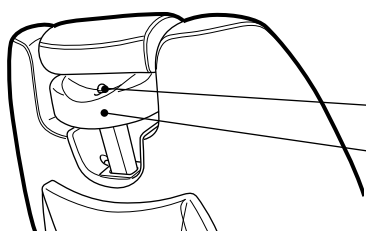

AB-LGS,LGSX

Headrest operation button

Headrest storage lever

■ Lift up Headrest

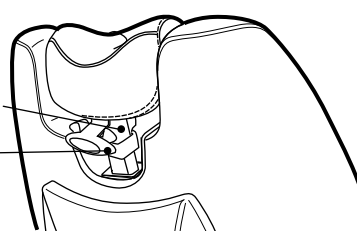

AB-LGL,LGLX,LGP,LGF

NAME OF COMPONENTS

■ Operating Section

Control Panel

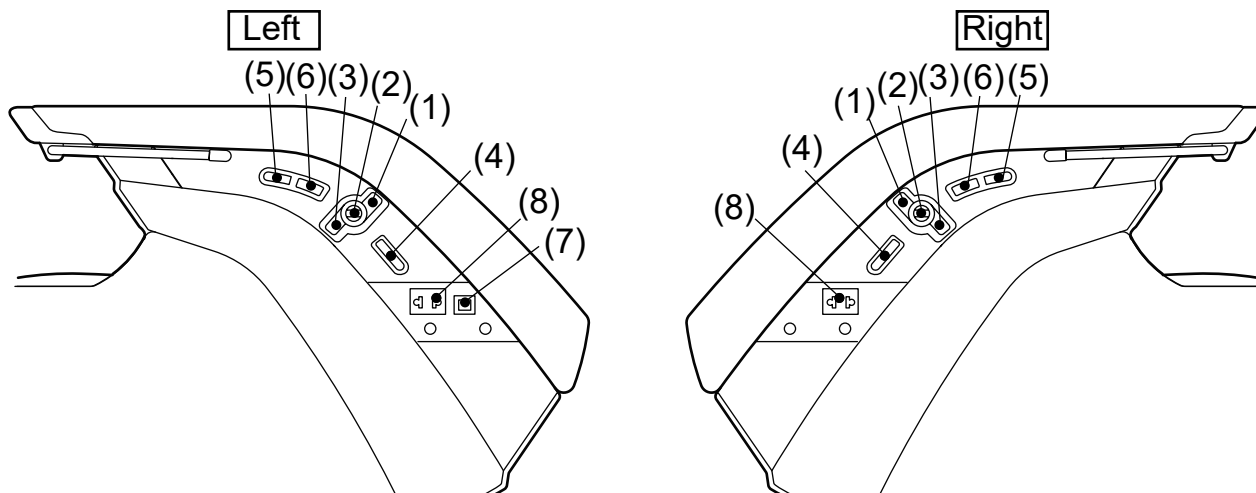

- (1) Backrest switch
- (2) UP/DOWN switch
- (3) Legrest switch
- (4) Auto-return switch

- (5) Preset switch P1
- (6) Preset switch P2
- (7) Legrest heater switch(AB-LGP,LGF)
Sheat arange mode swith(AB-LGSX,LGLX)
- (8) Service outlet

※There is service outlet Type C Specification.

Foot Control

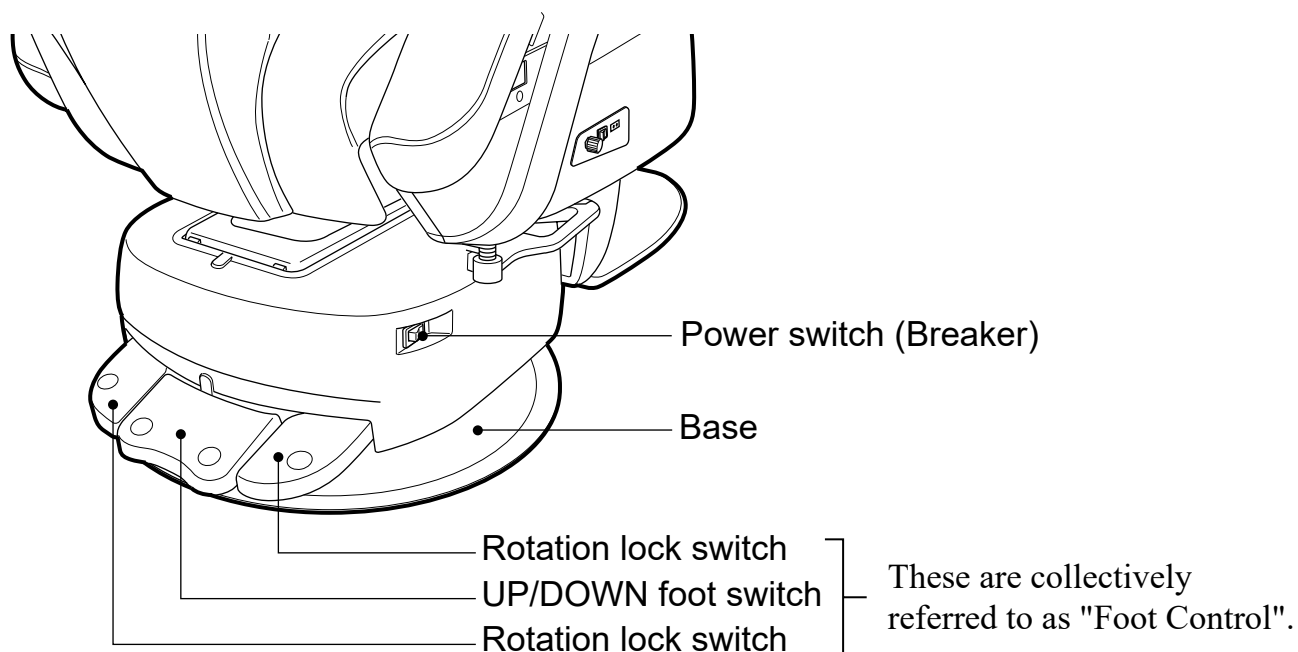

PREPARATION

Power Supply

1. Insert the power plug into the outlet.

- Be sure to fully insert the power plug into the outlet until reaching the base of the plug. Failure to fully insert the plug or similar fault can result in a short circuit or heat generation that causes a fire.
- Do not pull the cord to remove the power plug from the outlet. Hold by the power plug at the end of the cord when removing. Removing the plug by pulling the power cord can damage the power cord, resulting in electric shock or fire.
- Power cord replacement must be performed by your closest dealer, Takara Belmont or a technician with equivalent certification.
- Use an unshared * outlet with an attached ground terminal. Using the same outlet together with the power plug of other devices can result in abnormal heat generation and possible fire.
* 230V AC (12 A or more)
- Wiring work must be performed by certified personnel. Consult an electrician for wiring work.
- Do not connect the earth (ground) to the following objects.
- Water Pipes
Complete grounding is not possible as hard plastic pipes are widely used.
- Gas Pipes
Connecting to gas pipes can result in an explosion or fire.
- Lightning rods and telephone dedicated grounding wire
- Failure to make a ground connection can result in electric shock if there is a malfunction or short circuit. Consult an electrician for grounding procedures.

WARNING

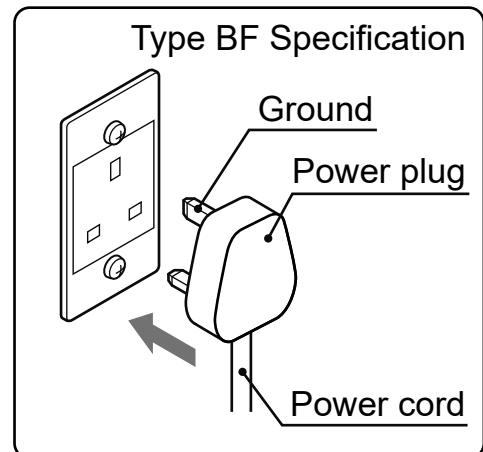
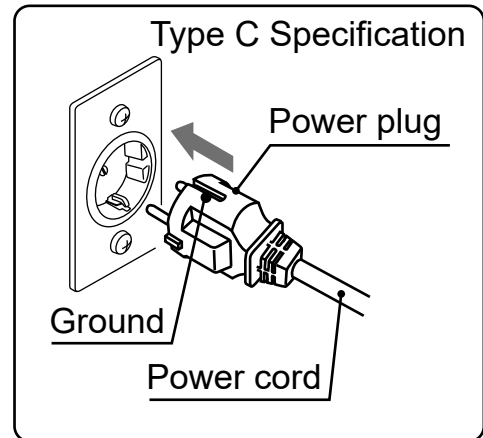

PREPARATION

2. Turn on the power.

Press the side with the  mark to turn the power on.

Press the side with the  mark to turn the power off.

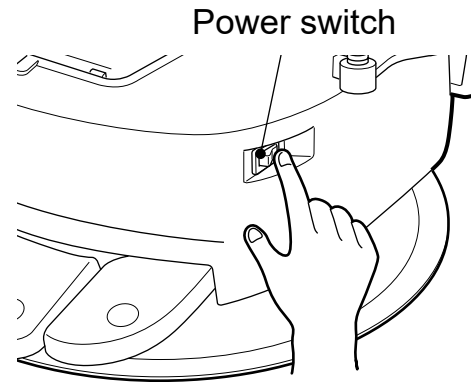
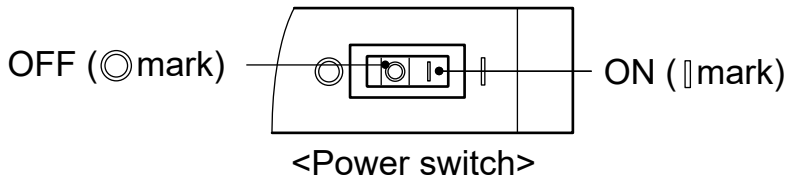

WARNING

Turn off the power switch and remove the power plug from the outlet when the chair is not in use. Unexpected operation can result in an accident or fire from a short circuit due to insulation aging.

CAUTION

- Turn off the power after use. Always operate the power switch by your hands only.
- Immediately wipe off any chemical solutions or water that has adhered to the chair by using a dry soft cloth. Chemical solutions can become a stain, and their adhering to an electrical part can cause faulty operation or short circuit.

HOW TO USE

(1) Guiding Customers

1. Rotate the chair so that the customer can be easily seated on the chair.

1 Release the base rotation with the rotation lock switch.

Pressing the rotation lock switch either at the foot control or the control panel releases the base rotation. (Operation is the same on either side.) Chair rotation is locked by hydraulic system. Each press of the rotation lock switch alternately locks and releases the base rotation.

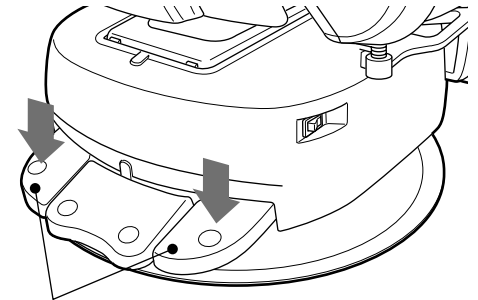

Rotation lock switch

2 Rotate the chair.

Hold the backrest or armrests when rotating the chair.

The chair is 360 degrees rotatable.

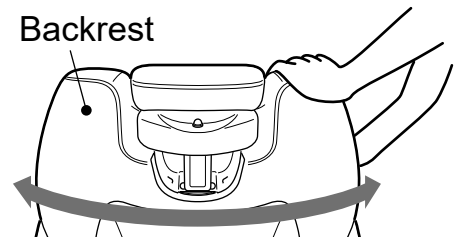

Backrest

3 Fix the chair in a work position.

Stop the chair at the desired work position and press the rotation lock switch in the foot control. The chair is locked and prevented from rotating.

When the power switch is turned on.

If the power is turned off, chair rotation gets locked automatically when the power is turned on.

When any of the switches are pressed.

If any of the switches of the foot control or control panel (excluding the legrest heater switch, seat arrange mode switch) is pressed, chair rotation is locked automatically.

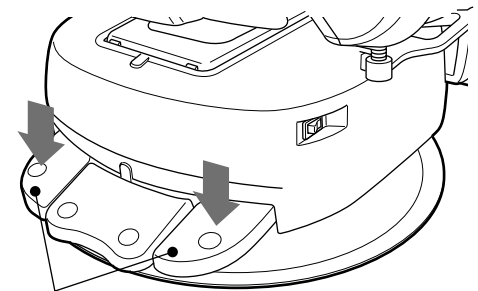

Rotation lock switch

<Foot Control>

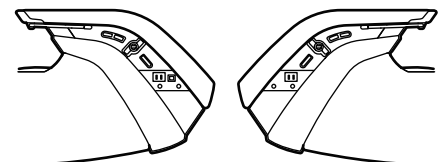

<Control Panel>

WARNING

- Always be sure to lower the chair to the lowest position and lock the rotation when a customer is getting in or out of the chair in order to ensure safety.
- When rotating the chair with a customer seated, always make sure that the customer is seated completely before rotating the chair.
- Always be sure that no other persons are in the surrounding area before rotating the chair, and rotate so that the step and other parts do not contact the customer or any nearby equipment. Be especially careful of the position of a reclined customer, and the customer's body, hands and feet when the backrest is reclined. Check that the safety of the customer is ensured before rotating the chair.
- Be careful that the adjuster under the step does not contact or catch on the power cord.
- Be sure to always lock (secure) chair rotation by using the rotation lock switch after rotating the chair. Always be sure that the chair rotation is locked before moving the chair. There is a danger of injury or damage if the chair rotates suddenly.
- Always be sure to lock the chair when not rotating it.

HOW TO USE

2. Using the cape holder

Using the cape holder:

- Provides space between the customer and the cutting cape to provide good ventilation.
- Makes it easy to clean up the cut off hair.

1 Pull out the front part of the cape holder to the side.

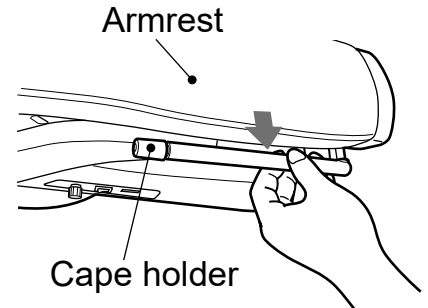

2 Rotate the pulled-out cape holder forward.

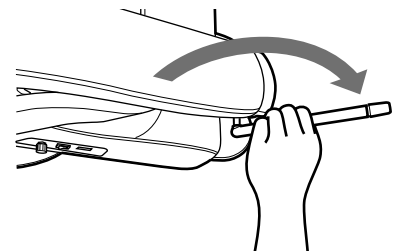

3 Pull out the tip of the cape holder and pinch the cutting cape.

(1) Pull from over the cutting cape.

(2) Pinch the barber cape and release.

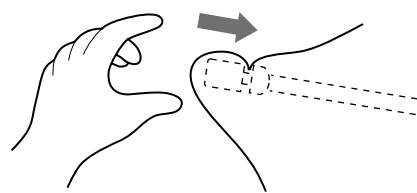
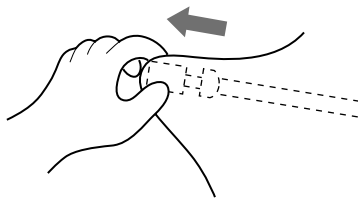

4 Rotate the cape holder rearward to store it.

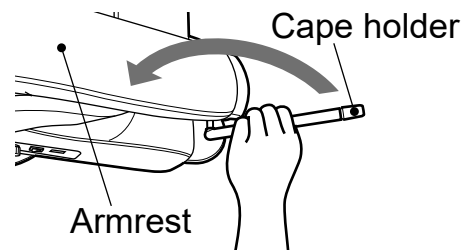

5 Push the root of the cape holder into the armrest.

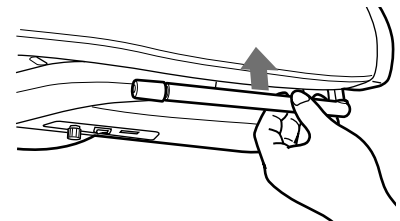

CAUTION

- Do not apply excessive force to the cape holder as it can only withstand a load of 10 N (1 kgf/2.2 lbf).
- Be sure to always return it to the stored state when not in use.
- When storing the cape holder, be careful not to pinch the customer's or user's fingers between it and the armrest.
- When using and storing the cape holder, please rotate the cape holder with hand.

HOW TO USE

(2) Raising/Lowering the Chair

1. Raising the chair

To raise the chair, step on the right side of the UP/DOWN foot switch on the foot control or press the UP/DOWN switch of the control panel upwards.

The chair operates while the stepping on (pressing) the switch.

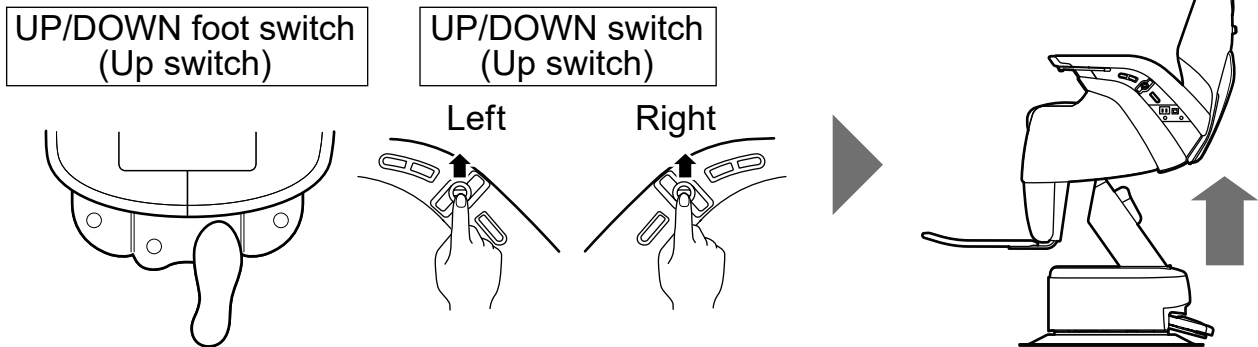

⇒ If any switch except for the legrest heater switch, seat arrange mode switch is pressed while the chair rotation lock is released, chair rotation is engaged and then locked.

2. Lowering the chair

To lower the chair, step on the left side of the UP/DOWN foot switch on the foot control or press the UP/DOWN switch of the control panel downwards.

The chair operates while the stepping on (pressing) the switch.

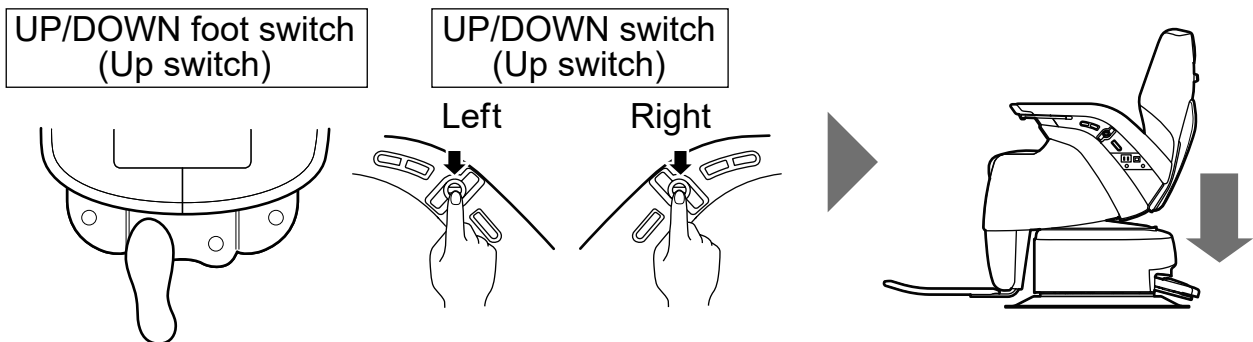

⇒ If any switch except for the legrest heater switch, seat arrange mode switch is pressed while the chair rotation lock is released, chair rotation is engaged and then locked.

WARNING

- Before raising or lowering the chair, always be sure to check that there are no persons or objects near the chair or step, or in the gap of the support arm. There is a danger of body parts being pinched, resulting in injury or damage.
- This chair moves backwards as it is raised. Thoroughly check that there are no obstructing items before and behind the chair.

HOW TO USE

(3) Reclining/Raising the Backrest

1. Pull out the headrest.

Use the headrest when supporting the customer's head is needed, such as for shaving.

Normal Headrest (AB-LGS,LGSX)

1 Lift up the headrest storage lever and pull up the headrest.

Headrest is fixed the position that release your hands.

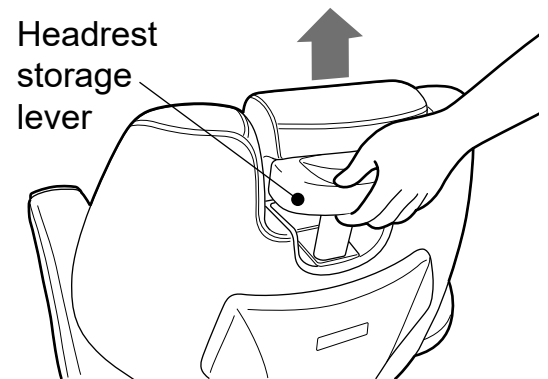

2 Store the headrest when finished using it.

While pressing the headrest operation button, return the headrest to its original position and lower it.

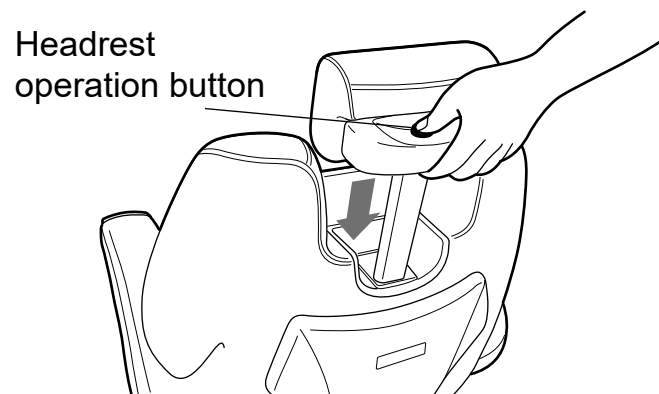

HOW TO USE

Lift up Headrest (AB-LGL,LGLX,LGP,LGF)

1 Lift up the headrest storage lever and pull up the headrest.

Secure the headrest at the desired position so that you can use it at that position. If the headrest is excessively pulled out, return it while pressing the headrest operation button.

When pulling out the stored headrest, do so without pressing the headrest operation button.



CAUTION

Pressing the headrest operation button when pulling out the headrest can cause the headrest to tip forward and scratch the backrest leather, resulting in strong force being applied to the leather and damage to the leather of the backrest.

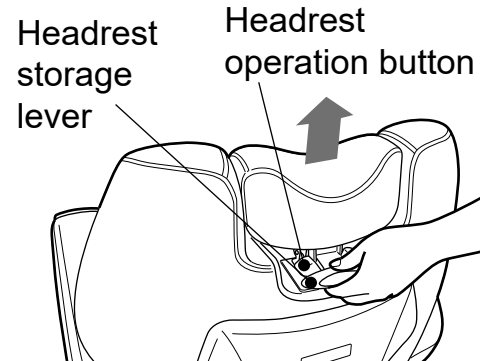

2 While pressing the headrest operation button, tip the headrest forward.

Tip the headrest forward to fit it against the customer's head so that the customer will be more comfortable even if used for an extended period.

Headrest operation button

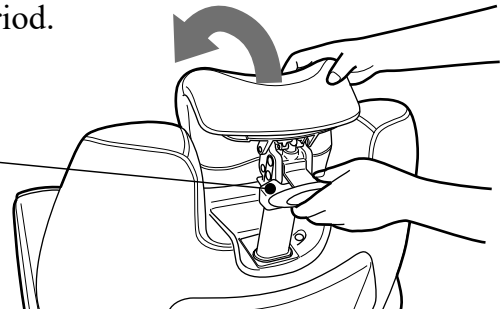

3 Store the headrest when finished using it.

While pressing the headrest operation button, return the headrest to its original position by the other hand and lower it.

When storing the headrest, return the headrest which is tipped forward by hand to its original position so that the headrest can be lowered.



CAUTION

Failure to return the tipped-forward headrest by hand can result in the headrest lowering and the headrest contacting the backrest leather, resulting in strong force being applied to the leather and damage to the leather of the backrest.

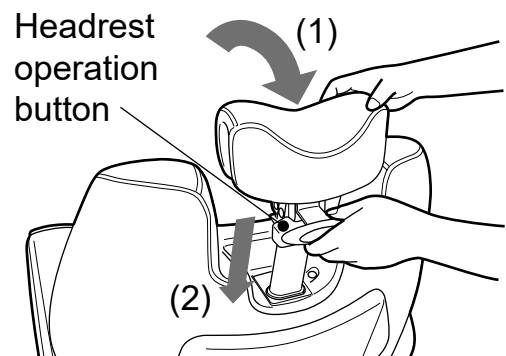

CAUTION

- Check that there are no impediments in the surrounding area when rotating the seat with the headrest pulled out.
- Do not apply excessive force to the headrest or strike it from above when it is pulled out. Doing so can result in damage.
- Be careful when operating the headrest that fingers and other body parts are not pinched between the area around the headrest storage button (or headrest operation button) or in between the backrest.
- Be sure to always store the headrest when shampooing with the customer's head back. Otherwise, the shampoo bowl will interfere with the headrest possibly resulting in breakage.

HOW TO USE

Remove or Install the headrest.

When the headrest is not used, the headrest inner pipe can be removed from the chair. To install the pipe, insert the inner pipe into the lock supporting rod while pressing the headrest storage button (or headrest operation button) and aligning with the guide.

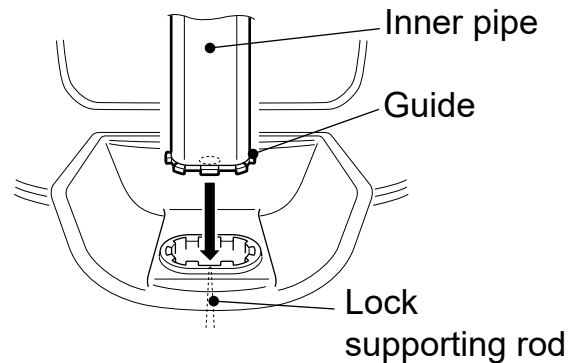

CAUTION

- Check that there are no impediments in the surrounding area when rotating the seat with the headrest pulled out.
- Do not apply excessive force to the headrest or strike it from above when it is pulled out. Doing so can result in damage.
- Be careful not to pull up the headrest more than necessary because doing so will make the headrest to come off the chair. Be careful when operating the headrest that fingers and other body parts are not pinched between the area around the headrest storage button (or headrest operation button) or in between the backrest.

HOW TO USE

2. Reclining the backrest

Push the backrest switch of the control panel in the direction of the arrow to recline the backrest. The chair operates while the switch is pressed.

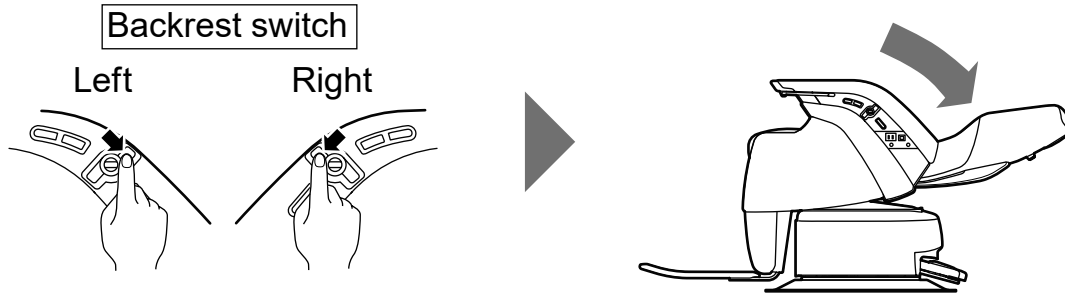

⇒ If any switch except for the legrest heater switch, seat arrange mode switch is pressed while the chair rotation lock is released, chair rotation is engaged and then locked.



WARNING

The space between the backrest and seat becomes narrow when the backrest is reclined. Check that the customer's hands or arms are not between the backrest and seat before reclining the backrest.

3. Raising the legrest

Push the legrest switch of the control panel in the direction of the arrow to raise the legrest. The chair operates while the switch is pressed. (AB-LGF: synchronized with the step.)

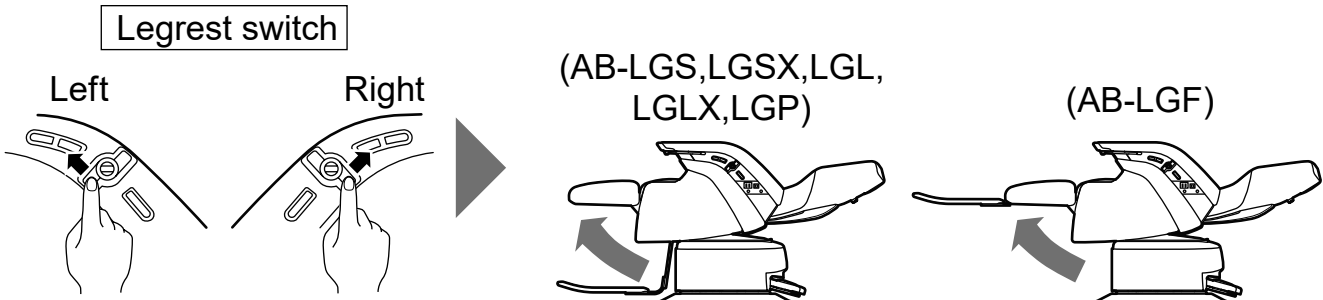

⇒ If any switch except for the legrest heater switch, seat arrange mode switch is pressed while the chair rotation lock is released, chair rotation is engaged and then locked.



WARNING

Before raising the legrest (step), be very careful that the step or the customer's feet will not contact any equipment in front of the step, and operate it safely.

HOW TO USE

4. Lowering the legrest

Push the legrest switch of the control panel in the direction of the arrow to lower the legrest. The chair operates while the switch is pressed.(AB-LGF:synchronized with the step.)

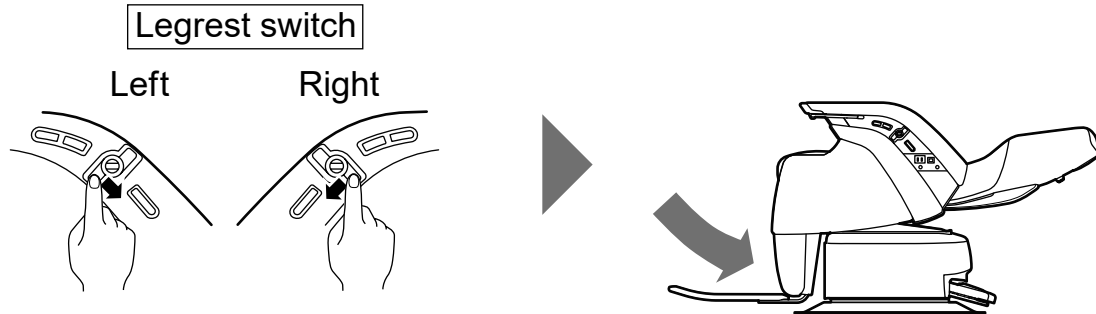

⇒ If any switch except for the legrest heater switch, seat arrange mode switch is pressed while the chair rotation lock is released, chair rotation is engaged and then locked.



WARNING

Before lowering the legrest (step), make sure that no persons or objects are under the legrest (step), and operate it safely.

5. Raising the backrest

Push the backrest switch of the control panel in the direction of the arrow to raise the backrest. The chair operates while the switch is pressed.

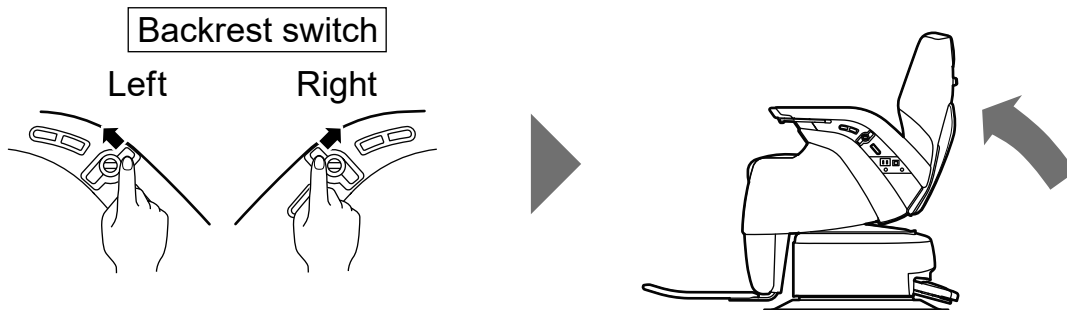

⇒ If any switch except for the legrest heater switch, seat arrange mode switch is pressed while the chair rotation lock is released, chair rotation is engaged and then locked.

Use the preset function to move the chair to the preset position.
Refer to "(5) Using Preset Functions" (P. 24).



WARNING

Before raising the backrest, check that the customer's elbows or hands are not in between the backrest and armrests, and operate it safely.

HOW TO USE

(4) Using seat arrange mode (AB-LGSX,LGLX)

This chair is equipped with a function that allows you to adjust only the seat section separately. Use this function to make the necessary adjustments.

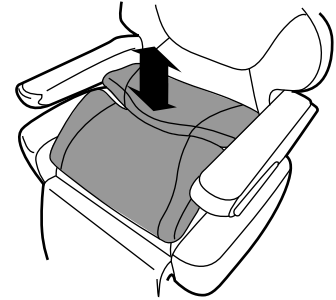

Push the seat arrange mode switch

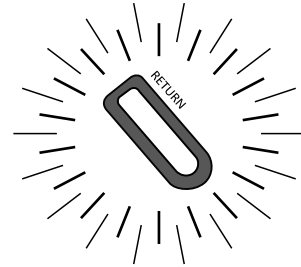
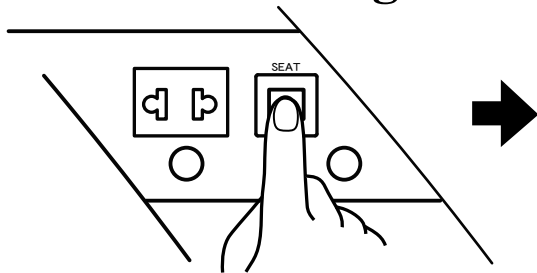

- ① Press the seat arrange mode switch of the control panel on the left side.
(The seat arrange mode switch indicator turns green, the electronic beep is emitted.)

- ② Auto-return switch is Flashing.

NOTICE

Press the same switch again once to turn the seat arrange mode off.
(Seat arrange mode switch indicator is off, the electronic beep is emitted. Seat arrange mode switch return to original lighting state.)

HOW TO USE

Setting the front shampooing position

Push the UP/DOWN switch on the control panel upwards. The seat continues to rise as long as you hold the switch. The front part of the seat tilts forward, allowing you to set the chair to the best position to provide treatment during front shampooing.

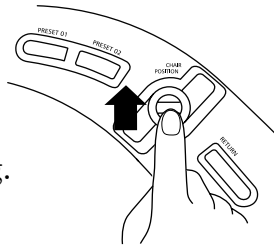

Side view of the seat

Front shampoo position

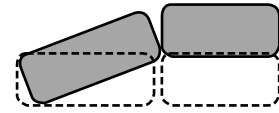

Child seat position

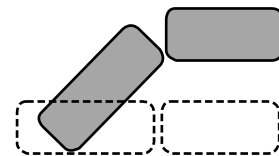

Neutral position



Setting the seat position for children

Press the UP/DOWN switch on the control panel upwards. The seat continues to rise as long as you hold the switch. The rear part of the seat is lifted horizontally, allowing you to set the chair to a position suitable for a child during cut and styling. If a child needs to use the legrest, you can adjust it by putting it in a horizontal position.

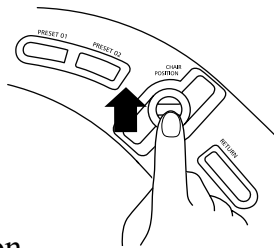

DOWN the seat position

Press the UP/DOWN switch on the control panel downwards. The seat continues to move down as long as you hold the switch.

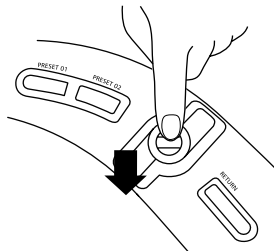

WARNING

- Do not raise or lower the child seat while a child is seated. Only allow a child to sit down after setting the chair to an appropriate position. If the child seat is raised or lowered while a child is seated, it may result in injury due to the child falling down or pinching body parts in the child seat gap.
- Before raising or lowering the seat, confirm the seat arrange mode. When not seat arrange mode, it operates Raising/Lowering the chair.
- Before raising or lowering the seat, always confirm that the child has not placed any body part below the seat, or in the gap between the seat and the armrest.

NOTICE

- When the seat is raised, the backrest is only able to recline a small amount (approx. 10°) to prevent falling over or dropping accidents. Before reclining the backrest, please return the Neutral position.
- The seat is not able to be raised while the backrest is reclined by a large amount (approx 10° or more) to prevent falling over or dropping accidents. Please return the backrest to the fully upright position before raising the seat.

(5) Using Preset Functions

1. Using the preset function

What is the preset function? ⇒ A press of the preset switch moves the chair to the preset position. You can set up to two optional positions of this chair.

1 Pull the headrest out to the desired position previously if you need to use it.

2 Press the preset switch on the control panel once.

The chair moves to the previously set position.

But when you adjusted seat position of AB-LGSX,LGLX,seat position moved Neutral position.

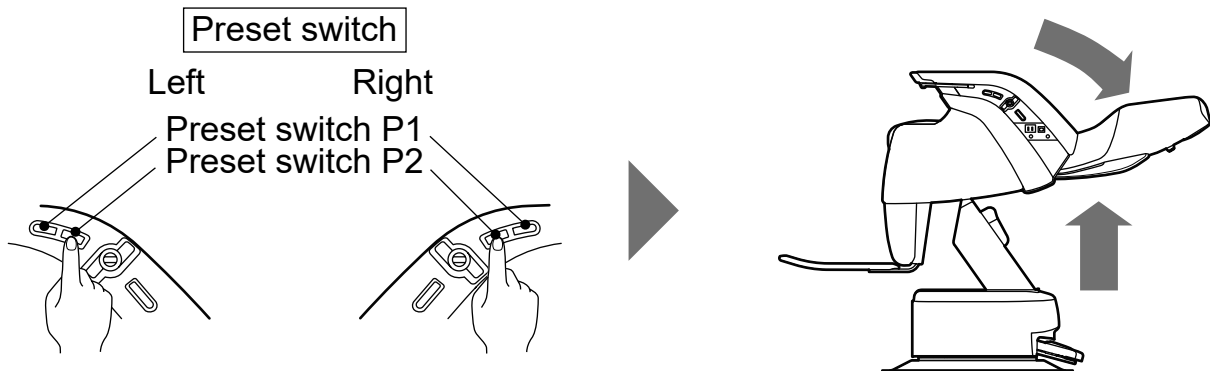

⇒ If any switch except for the legrest heater switch, seat arrange mode switch is pressed while the chair rotation lock is released, chair rotation is engaged and then locked.

<Changing Settings of the Preset Function>

Although the setting positions of the preset switches are previously set when shipped from the factory, you can change to the positions to match your customers.

But don't change the seat position of AB-LGSX,LGLX seat arrange function.

Perform the following procedures to change the preset positions.

- (1) Move the chair to the desired position.
- (2) Turn off the power switch, and then press and hold down a preset switch (P1 or P2) while you turn on the power switch.
- (3) Continue to press and hold the preset switch for approximately three seconds until you hear an electronic beep indicating that the position is set.
- (4) Setting is completed when the electronic beep is emitted. Return the chair to its original position by using the auto-return switch, and use the preset switch for which you have changed the setting to make sure that the chair moves to the position you have set.



WARNING

Be very careful when setting the position of the legrest that the customer's leg (step) will not contact equipment or other items near the chair.

HOW TO USE

2. Using the auto-return function

Press the auto-return switch on the control panel once. The chair height, backrest angle and legrest position return to their initial position (position for getting in/out of chair).

(For safety reasons, an electronic "pough" sound is emitted when operation starts.)

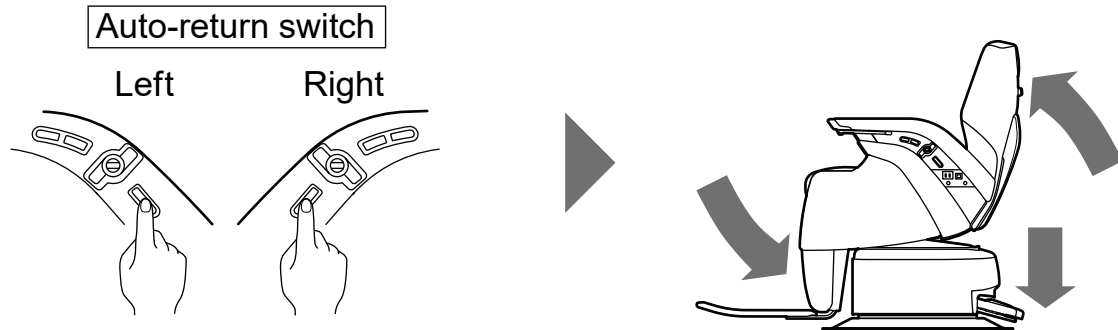

⇒ If any switch except for the legrest heater switch, seat arrange mode switch is pressed while the chair rotation lock is released, chair rotation is engaged and then locked.



WARNING

Before using the preset function or auto-return function, make sure that no persons, body parts, or objects are under the legrest or step, in the support arm area, or under the seat and operate it safely.

Cancel Function

Press any switch other than the legrest heater switch, seat arrange mode switch if you want to stop chair operation midway when using the preset or auto-return switches. The cancel function operates to stop chair movement.

(An electronic beep is emitted when auto-return operation is canceled.)

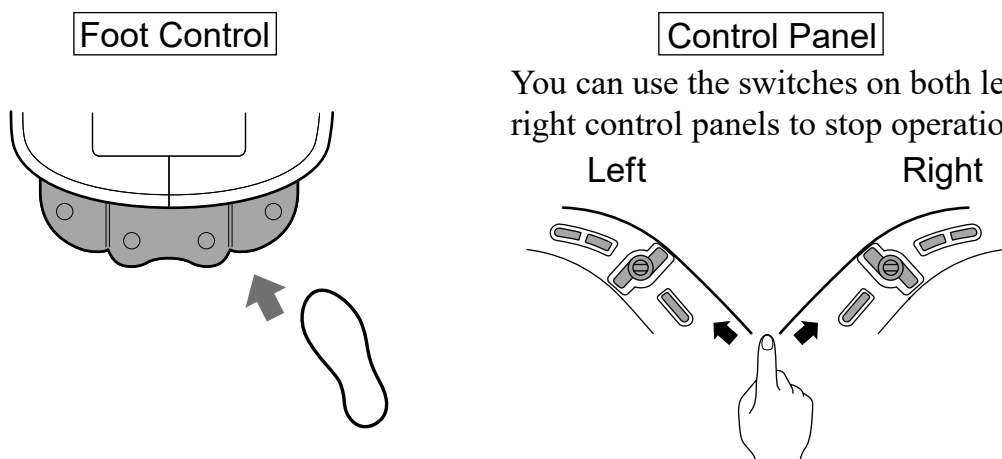

■ Pressing any of the switches shaded in gray will stop the operation.

HOW TO USE

(6) Removable Step

You can remove the step anytime it might interfere such as when sitting a wheelchair customer in the chair.

(AB-LGS,LGSX,LGL,LGLX,LGP)

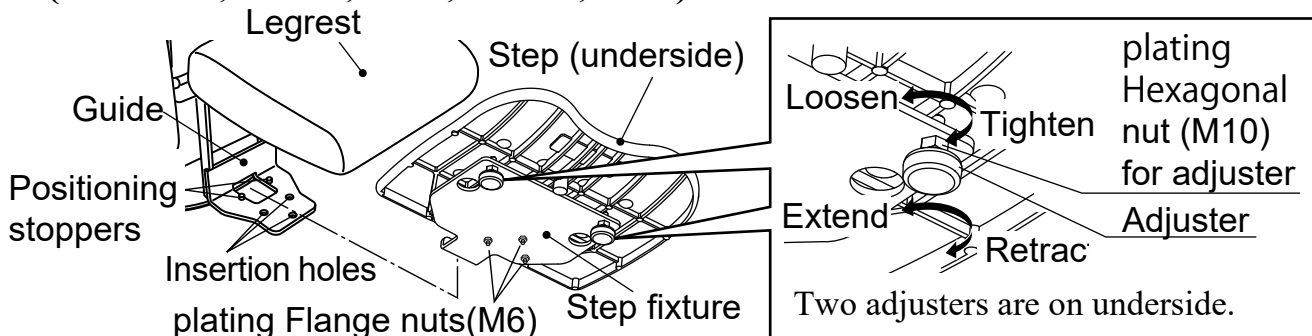

(AB-LGF)

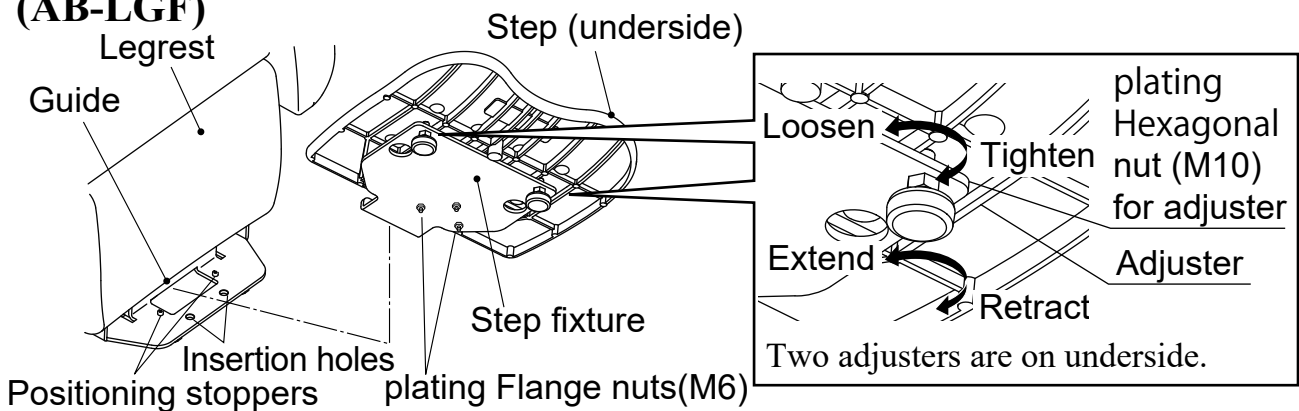

1. Remove the step.

Remove the step fixture held by the guide and remove the step.

2. Install the step.

- ⇒ • Holding the step fixture against the positioning stoppers, attach the step fixture to the guide, and securely insert the plating Flange nuts(M6) on the back side of the step into the two insertion holes.
- The adjuster, which prevents the chair from overturning, is located on the underside of the step. To adjust the adjuster, loosen the plating hexagonal nut (M10) by using a wrench (No. 17) to adjust the height of the adjuster, and then tighten the plating hexagonal nut (M10) by using a wrench (No. 17).

! WARNING

- After installing the step, check that the step fixture is securely held by the guide, the plating Flange nuts(M6) are inserted in the insertion holes, and the step is not loose. Be careful that there is no looseness as this could result in instability when the customer is getting in and out of the chair, and in rubbing against the upper surface of the step when the legrest is raised.
- When installing and removing the step, always make sure that the legrest is raised. (AB-LGS,LGSX,LGL,LGLX,LGP)
- Be careful when lifting and carrying the step, and of where you place it because the step is heavy. Dropping the step could result in serious injury.

! CAUTION

When extending the adjuster, be careful that the adjuster does not rub the floor or catch on the power cord during rotating the chair.

HOW TO USE

(7) Heater(AB-LGP,LGF)

The legrest heater is available on the customer's request.

1 Operating the heater

Press the legrest heater switch (indicated as "HEATER") on the control panel (chair left side) to operate the heater. (Heater light turns on.)

2 Stopping the heater

Press the legrest heater switch again to stop heater operation. (Heater light turns off.)

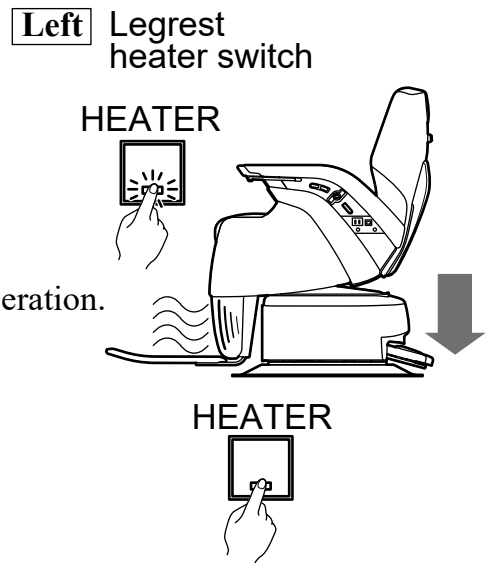

WARNING

The heater light is lit up in orange when the heater is operating. Be careful that using the heater for an extended period causes the temperature to increase, possibly resulting in burns or fire.

(8) Accumulator(AB-LGP,LGF)

This chair is equipped with an accumulator that reduces vibration when operating the chair. The accumulator absorbs loads applied to the chair to provide shock-free performance. Accordingly, the following conditions might be observed.

- The stopping position of the chair might vary due to slowly stopping the chair in order to absorb shocks.
- The chair might seem to slightly bounce due to load changes when getting in or out of the chair, or during massage.
- The chair might rise slightly when a customer gets out of the chair.

(Due to the load applied to the customer being absorbed when a customer sits, causing the chair to sink.)

NOTICE

Perform desired position setting of the preset function with a person sitting in the chair. As this chair is equipped with a shockless device, setting the desired position without someone sitting in the chair will result in slight variation of the final operating position.

HOW TO USE

(9) Dryer/Iron Holder

Pull out the dryer/iron holder under the body on the right side of the chair.
You can use this as a stand for a hand dryer or iron while working.

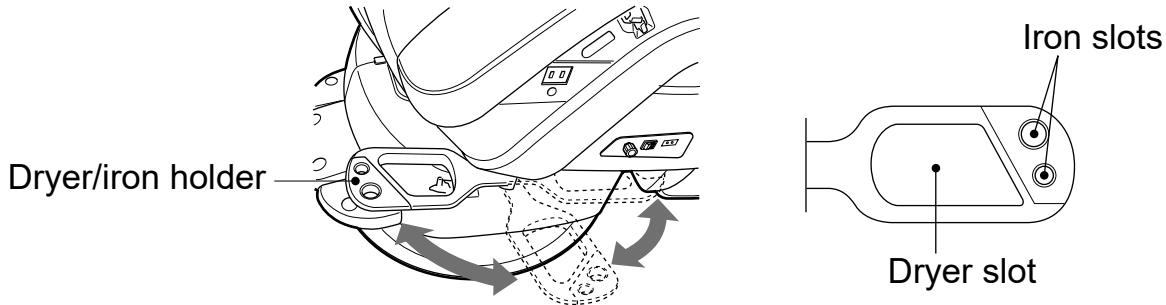

CAUTION

- Be careful that the dryer or iron does not contact the legs or other body parts of the customer when using the dryer/iron holder.
- Always be sure to store the holder under the body after use so it does not interfere with work.
- Do not rotate the dryer/iron holder with a hand dryer or iron still inserted in the slot. Doing so can damage the chair, and the heat can cause deformation or other damage.
- The dryer/iron holder can withstand a load of up to 50 N (5 kgf).

HOW TO USE

(10) Service Outlets (Type C Specification)

Total (right and left sides) electricity available for use is 230V AC / 12 A or less when not operating the chair, and 9 A or less for service outlets (right and left sides) when operating the chair.

The power switch on the right foot control (breaker) is turned off if the electricity available for use is exceeded. If this occurs, stop using the connected device(s), and turn on the power switch again.

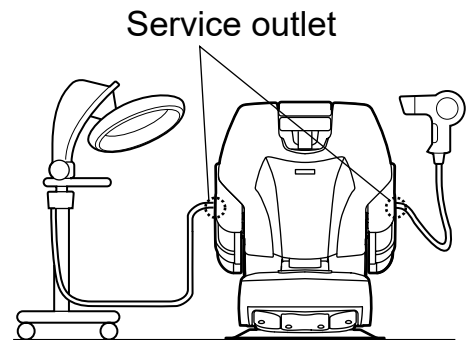

WARNING

The power plug becomes hot and can result in fire if the power plug of a device using a service outlet is not firmly plugged in or there is a looseness inside the outlet when using the service outlet. Immediately stop using the device, turn off the device power switch, and remove the power plug from the service outlet. Also, stop using the chair, turn off the power, unplug the power plug, and contact your closest dealer or distributor.

(11) Foot Cushion(AB-LGF)

This chair has a foot cushion that can be placed on the step on which the customer's legs can rest in order for the customer to recline with comfort.

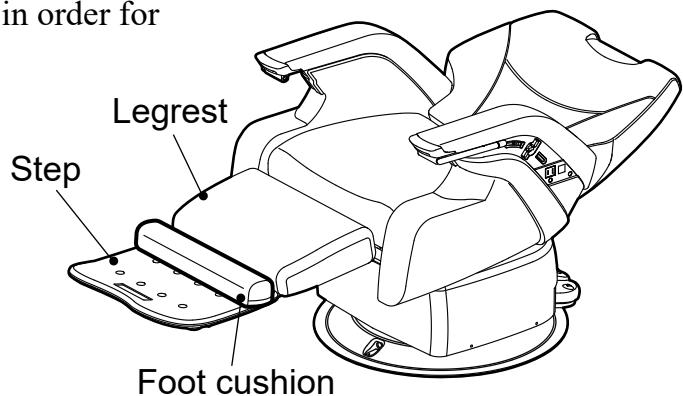

CAUTION

Always be sure to remove the foot cushion before returning the legrest to its original position. Returning the legrest with the cushion still located on the legrest can result in the cushion being pinched between the legrest and step.

CARE AND MAINTENANCE

Clean this chair after use to maintain it in a clean state. Leaving dirt or grime on the chair can result in the formation of mold. Always be sure to unplug the power plug from the outlet when cleaning the chair.

■ Cleaning of Each Part

Leather Parts

Lightly wipe clean using a dry soft cloth.

If extremely dirty

Wipe clean with a soft cloth that has been dabbed with a neutral detergent diluted with water to approximately one tenth. Then, wipe the area with a dry cloth.

Plastic Parts

Wipe clean using a dry soft cloth.

If extremely dirty

Wipe clean with a soft cloth that has been dabbed with a neutral detergent diluted with water to approximately one tenth. Then, wipe the area with a dry cloth.

Operating Parts Metal Parts

Wipe clean using a dry soft cloth.

Do not clean these parts with a wet cloth because they are readily affected by moisture and water. Wipe off all moisture immediately if any water gets on these parts. Water left on these parts will result in rust or malfunction of electronic parts.

CAUTION

- Do not use any of the following substances to clean the chair. Thinner, alcohol, nail polish remover, volatile chemicals (such as gasoline or kerosene), acid or alkaline solutions, chlorinated cleaners, disinfectants that are highly corrosive to metal, povidone iodine (iodine solution), sodium hypochlorite, waxes containing abrasive compounds, sponges containing abrasive compounds and similar substances.
- Do not use brushes, scouring brushes or similar items when cleaning the chair. Using them will damage the chair or result in the inability to clean off the dirt or grime.
- The metal part and mechanical section of the chair have sharp portions. Be careful when cleaning the chair that your hands, fingers or other body parts are not injured.

WARNING

- This chair is an electronic device. Do not sprinkle with water to clean it. Washing in such a manner can result in a malfunction or electric shock.
- Turn off the power switch and unplug the power plug before cleaning or wiping down the chair. Failure to do so can result in electric shock or fire. Also, movement of the chair while cleaning or wiping down can result in injury.

CAUTION

- Do not clean leather parts using a cleaner or bleach containing organic solvent or abrasive compounds. Such substances can cause the leather surface to deteriorate or dull the luster.
- If color from clothing, belt or similar item adheres to the leather, wipe off the stain as soon as possible by using a soft cloth that has been dabbed with a neutral detergent diluted with water to approximately one tenth in order to prevent the stain from soaking in due to the plasticizer. Then, wipe the area with a dry cloth.

To use a chair that has not been used for an extended period, clean before using and be sure to check that the chair operates safely without any error.

CARE AND MAINTENANCE

■ Spray-type Hairstyling Products (Especially hard types)

When using spray-type hairstyling products (especially hard types), check the entire chair to make sure that none of the product is adhering to the exterior surface of the chair (including leather parts). Immediately wipe off any hairstyling product that is adhering to the chair.

Failure to wipe off the product and allowing it to remain result in the hairstyling product hardening, leaving a feeling of roughness. Be especially careful of flat surfaces (such as the plastic covers) as this roughness is considerably noticeable on flat surfaces.

* If hairstyling product has hardened:

Clean off adhered and hardened hair product by using ethanol.

However, repeatedly cleaning off product adhering to plastic covers and leather parts by using ethanol can cause the surface to deteriorate, the luster to be lost, and cracking.

Immediately wiping off any adhering hairstyling product is the best method to prevent any problems of this type.

DAILY INSPECTION

Perform inspection according to the "Daily Inspection Procedures" indicated on pages 34 to 36 of this operation manual in order to ensure safe use of this chair.



WARNING

Perform daily inspection according to the "Daily Inspection Procedures". Using the chair without performing daily inspection can result in malfunction or accident.

BEFORE REQUESTING REPAIR

If any of the problems described below occur, conduct the checks outlined before requesting repair.

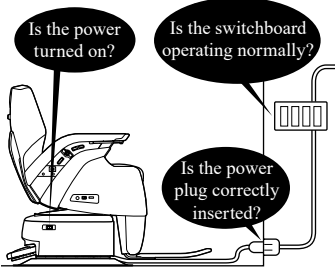
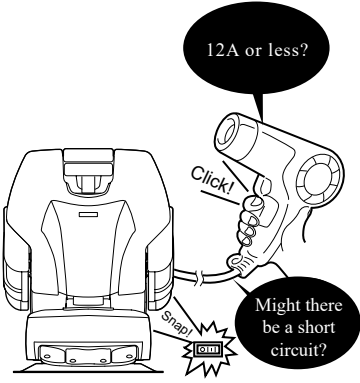
Problem	Check Points	Recovery Procedures
<p>■ Chair does not move.</p> 	<ul style="list-style-type: none"> ■ Is the power plug correctly inserted? ■ Is the power switch turned on? ■ Has a fuse of the shop's switchboard or breaker been tripped? ■ Has the chair been continuously operated for an extended period? 	<ul style="list-style-type: none"> ■ Correctly insert the power plug. (P. 12) ■ Turn on the power. (P. 13) ■ Replace the fuse of the switchboard or turn on the breaker. ■ The problem is due to the operation of the overheating prevention device. Leave the chair for approximately 10 min. to allow it to return to the normal condition. <p style="border: 1px solid black; padding: 2px; margin: 5px 0;">Overheating Prevention Device</p> <p>This is a protective circuit that prevents abnormal overheating of internal mechanisms due to continuous operation and similar causes. The chair might stop moving temporarily.</p>
<p>■ The power switch turns off when using the service outlet. (Type C Specification)</p> 	<ul style="list-style-type: none"> ■ Is the current used 12A or less? ■ Has there been a short circuit in one of the devices connected to the service outlet? 	<ul style="list-style-type: none"> ■ The breaker function operates if the current used exceeds 12A or less. Use an amount of current that is less than the rated capacity, and turn on the power again so that the chair will operate normally. (P. 29) ■ Switch to using a different device and try turning on the power switch. If the power cannot be turned on when using a different device, contact your closest dealer or Takara Belmont. <p style="border: 1px solid black; padding: 2px; margin: 5px 0;">Breaker Function</p> <p>This is a protective function that prevents damage to devices due to using a current that exceeds the 12A or less.</p>

BEFORE REQUESTING REPAIR

These are not malfunctions

- | | |
|--------------------------------------------------------------------------------------------------------------------------------------------------------------------------------------------------------------------------------|-------------------------------------------------------------------------------------------------------------------------------------------------------------------------------------------------------------------------------------------------------------------------------------------------------------------------------------------------------------------------------------------------------------------------------------------------------------------------------------------------------------------------------------------------------------------------------------------------------------------------------------------------------------------------------------------------------------------------------------------------------------------------------------------------------------------------------------------|
| <ul style="list-style-type: none">■ Abnormal sound at startup■ Sound when rotating the chair■ Child seat cannot be raised (AB-LGSX,LGLX)■ Backrest reclining prevented (AB-LGSX,LGLX) | <ul style="list-style-type: none">■ Such sound is due to the internal hydraulic fluid being cold and is not a functional fault. It will readily stop.■ This is the sound of the steel balls rolling when the chair is rotated. The level of this sound varies depending on the environment where the chair is installed.■ The seat is not able to be raised while the backrest is reclined by a large amount (approx 10° or more) to prevent falling over or dropping accidents. Please return the backrest to the fully upright position before raising the seat.■ When the seat is raised, the backrest is only able to recline a small amount (approx. 10°) to prevent accidents such as falling over or dropping. Before reclining the backrest, please return the seat to Neutral position. |
|--------------------------------------------------------------------------------------------------------------------------------------------------------------------------------------------------------------------------------|-------------------------------------------------------------------------------------------------------------------------------------------------------------------------------------------------------------------------------------------------------------------------------------------------------------------------------------------------------------------------------------------------------------------------------------------------------------------------------------------------------------------------------------------------------------------------------------------------------------------------------------------------------------------------------------------------------------------------------------------------------------------------------------------------------------------------------------------|

If any of the problems described above are inspected and the chair does not work normally even after performing the recovery procedures, immediately stop using the chair, turn off the power, unplug the power plug, and contact your closest dealer or Takara Belmont.

DAILY INSPECTION PROCEDURES

Perform the following inspection procedures in order to ensure that the chair can be used safely.

• Daily Inspection Procedures

Inspection Item	Inspection Procedures	Recovery Procedures if there is a Problem
<input type="checkbox"/> Check that the chair operates normally.	<input type="checkbox"/> Turn on the power switch, and check that a double beep with one to four pauses are not emitted intermittently. <input type="checkbox"/> Check that, approximately five seconds after turning on the power switch, a double beep with five pauses are not emitted intermittently. <input type="checkbox"/> Check that the chair moves normally to the preset positions by using the preset switches. <input type="checkbox"/> Check that the chair moves normally to the initial position (position for getting in or out of the chair) by using the auto-return switch. <input type="checkbox"/> Check that the chair raises and lowers by using the UP/DOWN switches and foot switches of the chair.	<input type="checkbox"/> Turn off the power switch, and wait approximately five seconds before turning on the power switch again. If the alarm still sounds, the position detector might be faulty. Stop using the chair, turn off the power, unplug the power plug, and contact your closest dealer or Takara Belmont. <input type="checkbox"/> Check that none of the operating switches are pressed. After checking that there is no object on top of the foot switch or other things, turn off the power switch, and wait approximately five seconds before turning on the power switch again. If the alarm still sounds, one of the operating switches might be faulty. Stop using the chair, turn off the power, unplug the power plug, and contact your closest dealer or Takara Belmont. <input type="checkbox"/> Perform the procedures indicated in "1 Using the Preset Function" under "How to Use" (P. 24). If operation is still not normal, stop using the chair, turn off the power, unplug the power plug, and contact your closest dealer or Takara Belmont. <input type="checkbox"/> Perform the procedures indicated in "2. Using the Auto-return Function" under "How to Use" (P. 25). If operation is still not normal, it might not be possible to safely get in and out of the chair. Stop using the chair, turn off the power, unplug the power plug, and contact your closest dealer or Takara Belmont. <input type="checkbox"/> Perform the procedures indicated in "(2) Raising/Lowering the Chair" under "How to Use" (P. 16). If operation is still not normal, it might not be possible to safely get in and out of the chair. Stop using the chair, turn off the power, unplug the power plug, and contact your closest dealer or Takara Belmont.

DAILY INSPECTION PROCEDURES

Inspection Item	Inspection Procedures	Recovery Procedures if there is a Problem
<input type="checkbox"/> Check that the chair operates normally.	<input type="checkbox"/> Check that the chair backrest can be reclined and raised by using the backrest switch. <input type="checkbox"/> Check that the chair legrest can be raised and lowered by using the legrest switch. <input type="checkbox"/> Check the seat arrange mode. Pressing UP/DOWN switch, check that seat raising and lowering. (AB-LGSX, LGLX) <input type="checkbox"/> Check that chair rotation can be locked and unlocked by using the rotation lock switch. <input type="checkbox"/> Check that there is no wobbling or abnormal noise when operating the chair. <input type="checkbox"/> Check that the chair stops at the desired position for a fixed period and does not sink.	<input type="checkbox"/> Perform the procedures indicated in "(3) Reclining/Raising the Backrest" under "How to Use" (P.20, 21). If operation is still not normal, it might not be possible to safely get in and out of the chair. Stop using the chair, turn off the power, unplug the power plug, and contact your closest dealer or Takara Belmont. <input type="checkbox"/> Perform the procedures indicated in "(3) Reclining/Raising the Backrest" under "How to Use" (P.20, 21). If operation is still not normal, it might not be possible to safely get in and out of the chair. Stop using the chair, turn off the power, unplug the power plug, and contact your closest dealer or Takara Belmont. <input type="checkbox"/> Perform the procedures indicated in "(4) Using seat arrange" under "How to Use" (P.22, 23). <input type="checkbox"/> Perform the procedures indicated in "1. Rotate the chair so that the customer can be easily seated on the chair." in "(1) Guiding Customers" under "How to Use" (P.14). If operation is still not normal, it might not be possible to safely get in and out of the chair. Stop using the chair, turn off the power, unplug the power plug, and contact your closest dealer or Takara Belmont. <input type="checkbox"/> If there is any wobbling or abnormal noise when operating the chair, stop using the chair, turn off the power, unplug the power plug, and contact your closest dealer or Takara Belmont. <input type="checkbox"/> If the chair does not stop for a fixed period and sinks, stop using the chair, turn off the power, unplug the power plug, and contact your closest dealer or Takara Belmont.

DAILY INSPECTION PROCEDURES

Inspection Item	Inspection Procedures	Recovery Procedures if there is a Problem
<input type="checkbox"/> Check that there are no abnormal odors emitted from the chair. <input type="checkbox"/> Check that no oil is leaking.	<input type="checkbox"/> Check that there are no abnormal odors emitted from the chair. <input type="checkbox"/> Check that no oil is leaking.	<input type="checkbox"/> Using the chair in such condition can result in abnormal operation or fire. Stop using the chair, turn off the power, unplug the power plug, and contact your closest dealer or Takara Belmont to inform of the abnormal situation. <input type="checkbox"/> Oil might be leaking from hydraulic parts. Stop using the chair, turn off the power, unplug the power plug, and contact your closest dealer or Takara Belmont.

SPECIFICATIONS

Model No.	AB-LGS/AB-LGSX/AB-LGL/AB-LGLX/AB-LGP/AB-LGF
Rated voltage	230 V AC
Rated frequency	50/60 Hz
Rated current	2.0 A AB-LGS, LGSX,LGL,LGLX 2.2 A AB-LGP, LGF
Weight	135 kg (298 lbs) AB-LGS, LGL, LGP 130 kg (286 lbs) AB-LGF 144 kg (317 lbs) AB-LGSX,LGLX
Max. load	1,350 N (135 kgf/300 lbf)
Operating noise volume	70 dB or less
Usage environment	Temperature 0 ~ 40°C Humidity 10 ~ 95% (No condensation) Air pressure 700 ~ 1060 hPa Use the product at an altitude of 3000m or less.
Transportation / Storage environment	Temperature -20 ~ 70°C Humidity 10 ~ 95% (No condensation) Air pressure 700 ~ 1060 hPa

SPECIFICATIONS

■ AB-LGS, AB-LGL, AB-LGP

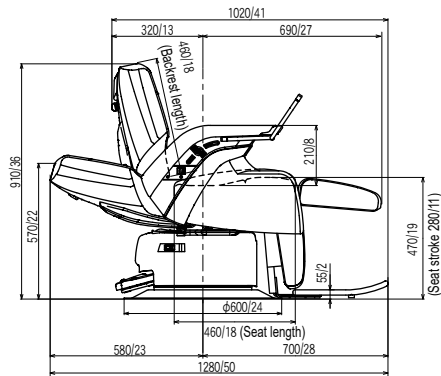

■ AB-LGF

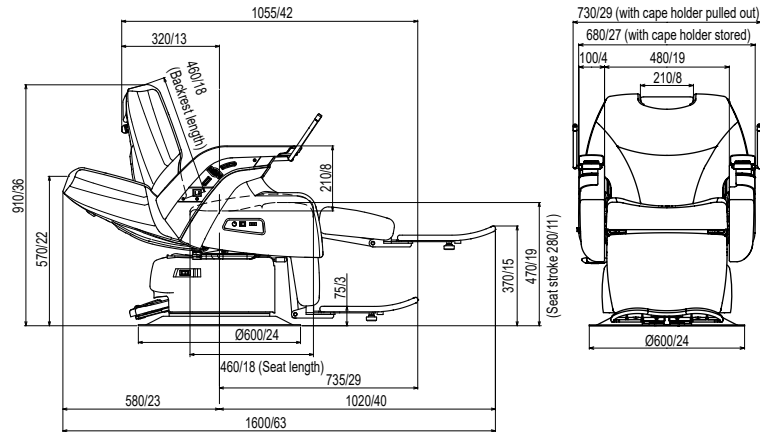

■ AB-LGSX, LGLX

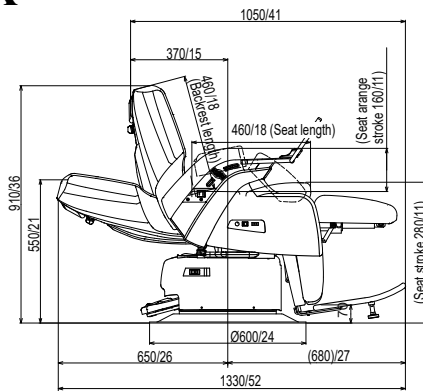

* Dimensions and specifications are subject to change without notice due to design improvement. Seat standard values are indicated (Unit: mm/inch).

STANDARD PERIOD OF USE

- The standard period of use of this chair is 10 years.
- The standard period of use is "an approximate standard period for which the chair can be safely used with no impediments to safety under the standard use conditions for each chair and while performing proper maintenance and inspection (including parts replacement). This is not a warranty period. The length of the "standard period" differs depending on the use environment and frequency of use of the customer. For maintenance after the standard period of use, contact your closest dealer or Takara Belmont.

DISPOSING OF THIS PRODUCT

Dispose of this chair and replaced parts in a proper manner that complies with local laws and regulations.

DECLARATION OF CONFORMITY

EU Declaration of Comformity

We hereby declare that the product listed below complies with the essential requirements of the EMC (electromagnetic compatibility) Directive:2014/30/EU, Low Voltage Directive:2014/35/EU, Machinery Directive:2006/42/EC and RoHS Directive:2011/65/EU based on category 11 of Annex I.

Product : BARBER CHAIR

Model : LEGEND

The product has been designed and manufactured in accordance with the European standards as the listed in the Declaration of Conformity.

UK Declaration of Comformity

We declare under sole responsibility that the device that is covered by the present declaration is in conformity with the following regulations and, if applicable, with any other relevant UK legislation that provides for the issuing of an UK declaration of conformity.

Product : BARBER CHAIR

Model : LEGEND

Regulations this product conforms to:

The Electrical Equipment (Safety) Regulations 2016, S.I. 2016/110

The Electromagnetic Compatibility Regulations 2016, S.I. 2016/1091

The Supply of Machinery (Safety) Regulations 2008, S.I. 2008/1597

The Restriction of the Use of Certain Hazardous Substances in Electrical and Electronic Equipment Regulations 2012, S.I. 2012/3032 based on category 11 of PART 1, SCHEDULE I

INTENDED USE OF THE PRODUCT

This product is intended for the exclusive use in hair salon for their treatment and service, and must be operated or handled by the qualified/professional hairdressers or by their staffs under the supervision of hairdressers.

Such hairdressers or staffs should instruct and/or assist the salon customers to approach to and leave from the product.

Salon customers should not be allowed to operate or handle the product unless he or she is so instructed.

IMPORTER INFORMATION

COUNTRY		REGISTERED PLACE OF BUSINESS & ADDRESS
GBR	Importer in UK	TAKARA BELMONT(U.K.)LTD. BELMONT HOUSE, ONE ST.ANDREWS WAY, BOW LONDON E3 3PA, ENGLAND
DEU	Importeur in Deutschland	TAKARA COMPANY EUROPE GmbH BERNER STRASSE 18, 60437 FRANKFURT/M,GERMANY
FRA	Importateur en France	TAKARA COMPAGNIE PARIS S.A.R.L. 56 rue des Hautes Pâtures 92009 NANTERRE Cedex France
ITA	Importatore in Italia	TAKARA BELMONT ITALY S.R.L. Via Marino Mazzacurati No.4/1, 42019 Scandiano RE, Italy

EU Authorised representative

TAKARA COMPANY EUROPE GmbH
Berner Strasse 18, 60437
Frankfurt am Main, Germany
TEL : +49 69 506878 0 / FAX : +49 69 506878 20



UK Authorised representative

Takara Belmont (U.K.) Ltd.
Belmont House, One St. Andrews Way,Bow
London E3 3PA, U.K.
TEL : +44-20-7515-0333 / FAX : +44-20-7987-3596



MANUFACTURER



TAKARA BELMONT CORPORATION
2-1-1, Higashishinsaibashi, Chuo-ku, Osaka, 542-0083, Japan
TEL : +81-6-6213-5945 / FAX : +81-6-6212-3680

2022-09 (9th edition)
BOOK NO. 1E051MJE
Printed in Japan